



Landscape Irrigation Products

2015 Catalog



The Intelligent Use of Water.™

**Preserving beauty while
conserving water.**

That's intelligent.

The Intelligent Use of Water™

At Rain Bird, we believe it is our responsibility to develop products and technologies that use water efficiently. Our commitment also extends to education, training and services for our industry and our communities.











Through innovative product development, Rain Bird is helping sustain healthier landscapes—and a healthier planet. A lush lawn or colorful garden can also be highly water-efficient. Every Rain Bird product is a testament to that truth.

From water-saving nozzles to sprays with pressure-regulating stems to leading-edge Smart Control Technology, Rain Bird products make the most of every drop, delivering superior results with less water. Keeping the world and your backyard beautiful. That's The Intelligent Use of Water.™

The need to conserve water has never been greater. We want to do even more, and with your help, we can.



Contents

	Spray Bodies	6
	Spray Nozzles	16
	Rotors	36
	Valves	58
	Controllers	79
	Central Controls	96
	Xerigation®/Landscape Drip	107
	Pump Stations and Filtration	153
	Drainage Products	167
	Resources	175
	Warranties	186
	Index	187

For information about Impacts, please visit www.rainbird.com/impacts

Water efficient Irrigation technology for every Landscape turf application

When you design and install Rain Bird complete irrigation solutions you can be confident to know that the system will perform better and last longer for many years to come. No matter what your irrigation needs are, Rain Bird has a solution that will help save water for every application in your next green project.

The landscape irrigation industry is changing. More restrictions are placed on water use every year. Irrigation professionals have two options, adapt and prosper or be left behind. As the Industry leader in water-efficient irrigation, Rain Bird can help your business thrive and take you to the next level in water management services.



Industrial, Business, Retail, and Shopping Centers



Municipal Buildings, Hospitals, Schools, and Universities



Residential Developments



1

Sprays Page 6

Thanks to a full range of sizes and options, with Rain Bird Spray bodies you'll have a solution for every irrigation challenge, from vandal protection to non-potable options. Rugged construction promotes years of reliable performance, while technologies like Seal-A-Matic™ (SAM) check valves and Pressure Regulating Stems (PRS) help save water.



2

Spray Nozzles Page 16

Rain Bird nozzles provide more uniform coverage and eliminate over-spray which can result in substantial water savings. High Efficiency nozzles, easy, flexible adjustments and matched precipitation rates provide high distribution uniformity and wind resistant droplets.

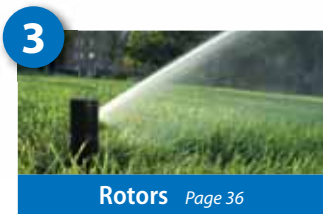

3

Rotors Page 36

Rain Bird Rotor Sprinklers set the standard for durability, and come stocked with features like; Rain curtain nozzles, optional Flow Shut-Off, Pressure Regulating Stems (PRS) with Flow Optimizer™, or Seal-A-Matic check valves. For applications with low pressure and steep slopes, in high wind areas, non-potable water or areas where vandalism could be a problem.



4

Valves Page 58

Down and dirty. Hard working. Built to last. Rain Bird valves can handle the toughest jobs, under the worst conditions. In durable plastic or rugged brass, for low flows and high, even working in effluent water -- there's a Rain Bird valve for every application.

Complete irrigation solutions for the Intelligent Use of Water.™

The best solutions and exceptional performance you can always count on

For more than 80 years, we've been developing new and innovative products with effective water saving features, from the XFS subsurface dripline with Copper Shield™ Technology to 1800 pop-up sprays with Seal-A-Matic™ check valves and pressure regulation, easy to program controllers, to Rotors with Rain Curtain nozzles, Rain Bird's award winning products have not only kept landscapes green, they've also helped revolutionize the industry.

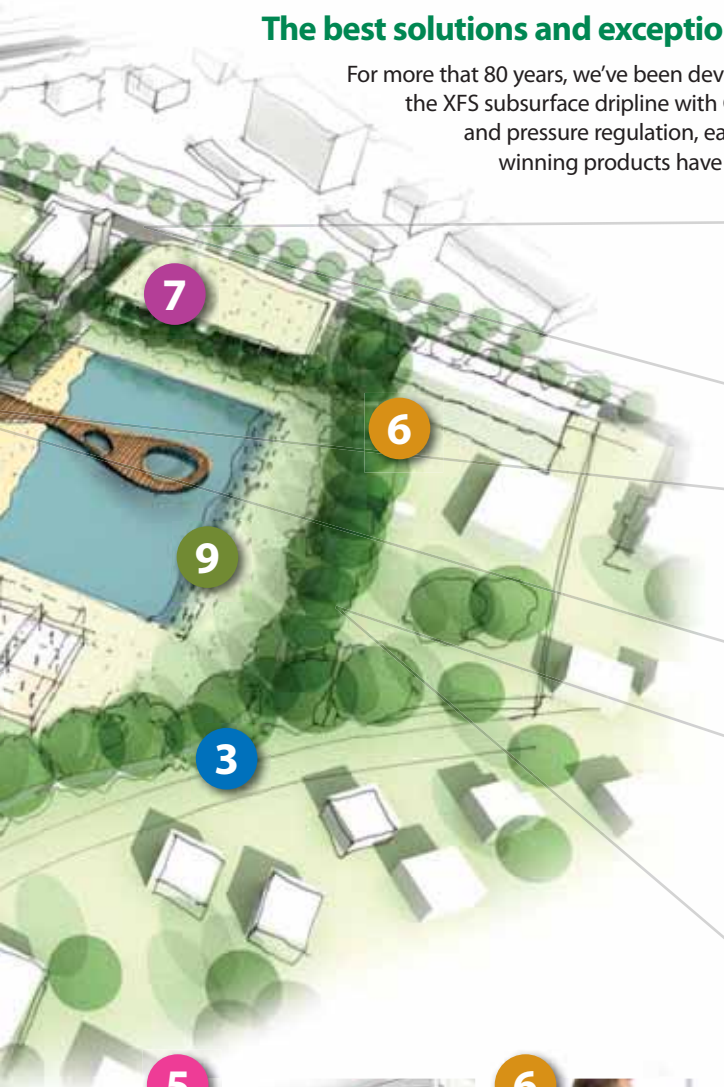

Roads, Highways,
Medians, and Walkways



Hotels, Resorts,
and Theme Parks



Parks and Recreation,
Public Spaces, Cemeteries,
and Sports Fields



5 **Controllers** Page 79

All Rain Bird controllers simplify conservation through a variety of water saving features. Flexible programming, Smart Controller Technologies, automatic Shut-Off devices along with many other powerful advanced features and easy to use options make the full line of Rain Bird controllers the ideal choice for Residential and Light Commercial Use.



6 **Central Control** Page 96

Rain Bird developed the original computer based central control system in the 1970s and today has thousands of systems installed worldwide designed to monitor and automatically adapt system operation and irrigation run-times in response to conditions in the system and surrounding area (weather change, pipe breaks, etc.) as well as parameters defined by the operator.



7 **Drip Irrigation** Page 107

Rain Bird Xerigation/Landscape Drip products are made especially for low-volume irrigation systems. By delivering water at or near the plants' root zones, Rain Bird Xerigation products offer targeted watering with greater efficiency for healthier plants and outstanding water savings. With over 150 products, Rain Bird has the broadest drip irrigation product line in the industry to meet any site requirements.



8 **Pumps & Filtration** Page 153

Rain Bird offers a variety of irrigation pump stations and filtration products to meet your specific application needs.

Drainage Products Page 167

Ruggedly constructed Rain Bird grates, basins and accessories can help you efficiently manage water run-off and surface drainage for virtually any residential, commercial or municipal site.

Spray Bodies

Introduction

Spray Bodies

Spray Nozzles

Rotors

Valves

Controllers

Central Controls

Landscape Drip

Pumps

Drainage Products

Resources



"We've installed more than 100,000 Rain Bird 1800 Series Spray Heads because we trust their consistent quality.

We've been using Rain Bird 1800 Series Spray Heads and Nozzles exclusively for nearly 20 years. Rain Bird products serve our customers well and have helped us become one of the leading landscape companies in the Portland area."

Rodney Reed, President
Green Earth Landscaping, Inc.

Major Products

	1802, 1804, 1806	1812	1800 PRS	1800 SAM	1800 SAM-PRS	1800 SAM-PRS-45	US-200, US-400	1300/1400 Bubbblers	PA-80 PA-8S PA-8S-NP PA-8S-PRS	RD-04, RD-06	RD-12	RD1800 SAM	RD1800 SAM-PRS	RD1800 SAM-PRS-F	RD1800 SAM-PRS-45-F
Primary Applications															
Turfgrass	●		●	●	●	●	●			●		●	●	●	●
Slopes				●	●	●	●*					●	●	●	●
Ground Cover/Shrubs	●	●	●	●	●	●	●	●	●	●	●	●	●	●	●
High Pressure Systems			●		●	●		●	●	●	●	●	●	●	●
Low Pressure Systems	●	●					●	●	●	●	●				
High Wind Areas	●	●	●	●	●	●	●	●	●	●	●	●	●	●	●
Non-Potable Water									●	●	●	●	●	●	●
Vandalism/Damage Prone														●	●
Dirty Water										●	●	●	●	●	●

*Optional US-SAM check valve is retrofitable on all UNI-Sprays.™



Water Saving Tips

- The patented, built-in PRS regulator maintains optimal operating pressure and restricts water loss by up to 70% if a nozzle is removed or damaged. It also ends water waste by eliminating misting and fogging caused by high pressure.
- Save water, stop low head drainage, and reduce water hammer by preventing water from draining out of pipes after irrigation with 1800 Series Sprays featuring Seal-A-Matic™ (SAM) check valves.
- Exclusive Flow Shield Technology provides up to 90% reduction in water loss when a nozzle is removed, preventing potentially costly and unacceptable run-off.

UNI-Spray™ Series

Compact and reliable spray heads for any application

Features

- Small exposed cover makes the unit virtually invisible for more attractive landscapes
- Constructed of durable materials including corrosion resistant stainless steel, assuring long product life even in high pressure or surge conditions
- Pressure-activated wiper seal prevents excessive flow-by and water waste and keeps debris from entering upon retraction
- Two-piece ratchet mechanism allows easy nozzle pattern alignment and provides added durability
- Three Year Trade Warranty

Operating Range (for pre-installed nozzle choices)

- Spacing:
 - 10 VAN Series: 8 to 10 feet (2.4 to 3.0 m)
 - 12 VAN Series: 10 to 12 feet (3.0 to 3.7 m)
 - 15 VAN Series: 12 to 15 feet (3.7 to 4.6 m)
 - 18 VAN Series: 14 to 18 feet (4.3 to 5.5 m)
- Pressure: 15 to 70 psi (1.0 to 4.8 bar)
- Optimum pressure: 30 psi (2.1 bar)
- Adjustable nozzle arc range: 0° - 360°

Specifications

- Flow-by: 0 at 10 psi (0.75 bar) or greater; 0.20 gpm (0.04 m³/h; 0.60 l/m) otherwise

Models*

- US-400: 4" pop-up height (10.2 cm)
- US-215 VAN 2" pop-up height (5.1 cm) with 15-VAN attached
- US-410 VAN 4" pop-up height (10.2 cm) with 10-VAN attached
- US-412 VAN 4" pop-up height (10.2 cm) with 12-VAN attached
- US-415 VAN 4" pop-up height (10.2 cm) with 15-VAN attached
- US-418 VAN 4" pop-up height (10.2 cm) with 18-VAN attached
- US-SAM UNI-Spray field installed check valve

*The UNI-Spray accepts all Rain Bird nozzles



Variable Arc Nozzles
(10, 12, 15 or 18 feet) are available pre-installed



UNI-Spray™

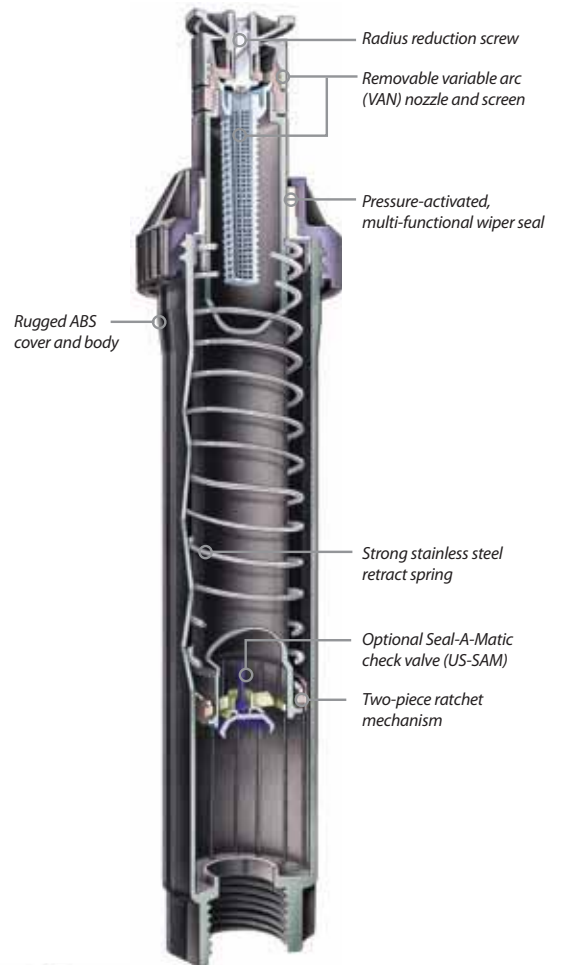

How To Specify

US - 4 - 15VAN

Nozzle Series/Pattern
VAN nozzle with variable arc

Body
2" (5.1 cm)
4" (10.2 cm)

Model
UNI-Spray

1800® Series

The #1 irrigation spray head in the world

Features

- Co-molded wiper seal provides unmatched resistance to grit, pressure and the environment
- Constructed of time-proven UV-resistant plastic and corrosion resistant stainless steel parts, assuring long product life
- Precision controlled flush at pop-down clears debris from unit, assuring positive stem retraction in all soil types
- Two-piece ratchet mechanism allows easy nozzle pattern alignment and provides added durability
- Five Year Trade Warranty

Operating Range

- Spacing: 2.5 to 24 feet (0.8 to 7.3m)**
- Pressure: 15 to 70 psi (1.0 to 4.8 bar)

Specifications

- Flow-by: 0 gpm at 8 psi (0.6 bar) or greater;
0.10 gpm (0.02 m³/h; 0.36 l/m) otherwise

Dimensions/Models

- ½" (15/21) NPT female threaded inlet
- Models and height:
 - 1802: 4" (10.2 cm) body height; 2" pop-up height (5.1 cm)
 - 1804: 6" (15.2 cm) body height; 4" pop-up height (10.2 cm)
 - 1806: 9³/₈" (23.8 cm) body height; 6" pop-up height (15.2 cm)
 - 1812: 16" (40.6 cm) body height; 12" pop-up height (30.5 cm)
- Exposed surface diameter: 2¼" (5.7 cm)

* 1806 and 1812-SAM, SAMPRS, and SAM-PRS-45 units do not have a side inlet

** 2.5 to 18 feet with standard Rain Bird Spray Head Nozzles (SQ, MPR, VAN, USeries) 13 to 24 feet with Rain Bird Rotary Nozzles

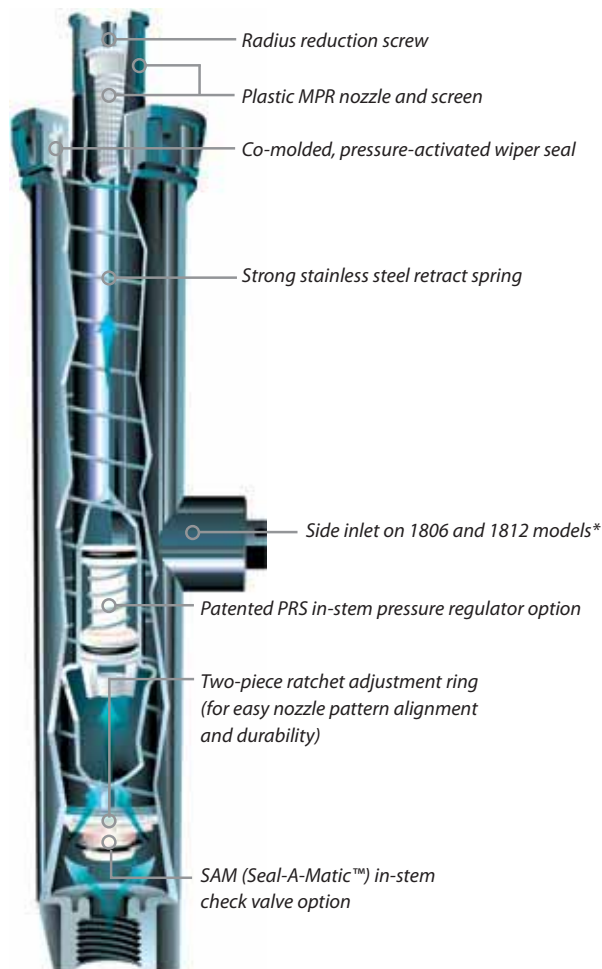

How To Specify

1804 SAM-PRS

Option
SAM: Seal-A-Matic™ check valve
PRS: Pressure regulator

Pop-up Height

1802: 2" pop-up height (5.1 cm)
1804: 4" pop-up height (10.2 cm)
1806: 6" pop-up height (15.2 cm)
1812: 12" pop-up height (30.5 cm)

Model

1800 Series Spray Bodies

1800®-SAM, 1800®-PRS, 1800®-SAM-PRS, 1800®-SAM-P45 Series

4", 6", 12" (10.2 cm, 15.2 cm, 30.5 cm)

Features

- **1800®-SAM Series:** Built-in Seal-A-Matic™ (SAM) check valve. Eliminates the need for under-the-head check valves. Traps water in lateral pipes in elevation changes of up to 14 feet (4.2 m). Reduces wear on system components by minimizing water hammer during start-up
- **1800®-PRS Series:** Maintains constant outlet pressure at 30 psi (2.1 bar). PRS pressure regulator built into the stem simplifies system design. Eliminates misting and fogging caused by high pressure. Saves time and money
- **1800®-SAM-PRS Series:** Incorporates all 1800 Series SAM and PRS features. Meets the needs of all spray areas, regardless of changing elevation or water pressures
- **1800®-SAM-P45 Series:** Maintains constant outlet pressure at 45 psi (3.1 bar) at varying inlet pressures. Ensures maximum spray body and nozzle performance, even with varying inlet pressures. Maintains constant pressure regardless of nozzle used

Specifications

- SAM capability: holds up to 14 feet (4.2 m) of head; 6 psi (0.4 bar)
- PRS model: Regulates nozzle pressure to an average 30 psi (2.1 bar) with inlet pressures of up to 70 psi (4.8 bar)
- Flow-by: 0 gpm at 8 psi (0.6 bar) or greater; 0.10 gpm (0.02 m³/h; 0.36 l/m) otherwise
- Installation: side or bottom inlet
- Side inlet installation not recommended in freezing climates
- Five Year Trade Warranty

1800-SAM Models

- 1804-SAM: 4" pop-up height (10.2 cm)
- 1806-SAM: 6" pop-up height (15.2 cm)
- 1812-SAM: 12" pop-up height (30.5 cm)

1800-PRS Models

- 1804 PRS: 4" pop-up height (10.2 cm)
- 1806 PRS: 6" pop-up height (15.2 cm)
- 1812 PRS: 12" pop-up height (30.5 cm)

1800-SAM-PRS Models

- 1804-SAM-PRS: 4" pop-up height (10.2 cm)
- 1806-SAM-PRS: 6" pop-up height (15.2 cm)
- 1812-SAM-PRS: 12" pop-up height (30.5 cm)

1800-SAM-P45 Models

- 1804-SAM-P45: 4" pop-up height (10.2 cm)
- 1806-SAM-P45: 6" pop-up height (15.2 cm)
- 1812-SAM-P45: 12" pop-up height (30.5 cm)



Operating Range

- Spacing: 2.5 to 24 feet (0.8 to 7.3m)*
- Pressure: 15 to 70 psi (1.0 to 4.8 bar)



1800-SAM



1800-PRS



1800-SAM-PRS



1800-SAM-P45

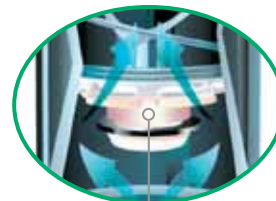

Built in Seal-A-Matic check valve prevents low-head drainage, ideal for use in changing elevations

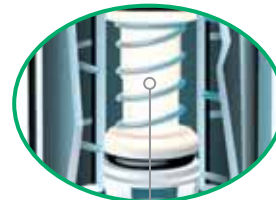

Patented pressure regulator in stem compensates for high or fluctuating water pressure to ensure maximum performance

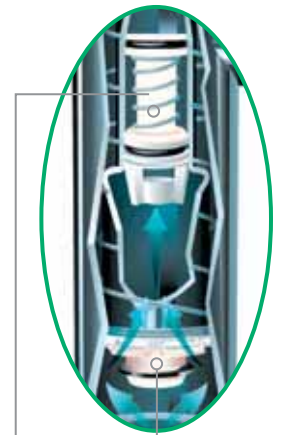

Top-of-the-line spray head includes all the features of the SAM and PRS series, ideal regardless of pressure or elevation

* 2.5 to 18 feet with standard Rain Bird Spray Head Nozzles (SQ, MPR, VAN, U-Series), 13 to 24 feet with Rain Bird Rotary Nozzles

RD1800™ Series Spray Heads

4", 6", 12" (10.2 cm; 15.2 cm; 30.5 cm)

Features

- Patented, Triple-Blade Wiper Seal precisely balances flushing, flow-by and debris protection to optimize performance and durability at pop-up and retraction. Precision-controlled flushing at pop-up and retraction clears debris, assuring positive stem retraction in all soil types
- Unique debris pockets hold grit in place, removing it from circulation and preventing long-term damage. Parts resistant to corrosion in treated recycled water containing chlorine
- **RD1800™ SAM Series:** Built-in Seal-A-Matic™ (SAM) check valve. Eliminates the need for under-the-head check valves. Prevents drainage from spray heads at lower elevations. Stops water waste and ends landscape damage due to flooding and erosion
- **RD1800™ SAM PRS Series:** Incorporates all RD1800 Series SAM and PRS features. Meets the needs of all spray areas, regardless of changing elevation or water pressures
- **RD1800™ Flow-Shield™ Series:** Provides low flow vertical water jet visible from +200' line of sight when a nozzle has been removed
- **RD1800™ Non-Potable Water Series:** Provides an alternative to clip-on caps and molded purple covers. Easy-to-read English "DO NOT DRINK", Spanish "NO BEBA" warnings, and international do not drink symbol

Operating Range

- Spacing: 2.5 to 24 feet (0.8 to 7.3 m)
- Pressure: 15 to 100 psi (1.0 to 6.9 bar)

Specifications

- SAM capability: Holds up to 14 feet (4.2 m) of head; 6 psi (0.3 bar)
- Flow-by: SAM Models: 0 at 15 psi (1.0 bar) or greater; 0.5 gpm (0.1 m³/h; 0.03 l/s) otherwise
All Other Models: 0 at 10 psi (0.7 bar) or greater; 0.5 gpm (0.1 m³/h; 0.03 l/s) otherwise
- SAM-PRS model: Regulates nozzle pressure to an average 30 psi (2.1 bar) with inlet pressures of up to 100 psi (6.9 bar)
- Side inlets featured on non Seal-A-Matic™ (SAM) models only
- Five-year trade warranty

Dimensions

- ½" (15/21) NPT female threaded inlet

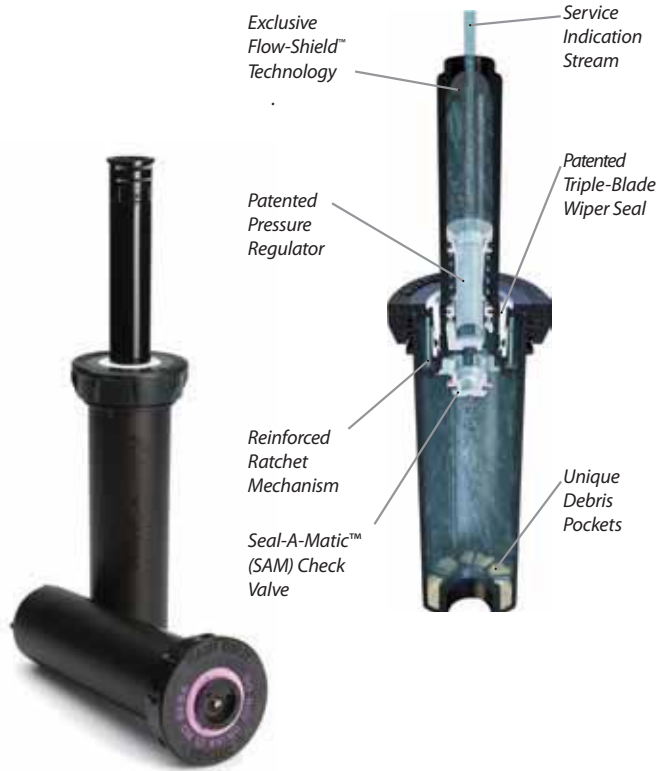

RD1800 Series



Standard Cover



Non-Potable Cover

Models

4" Models		6" Models		12" Models	
RD-04-NP	RD-04-S-P30-F	RD-06	RD-06-S-P30-F	RD-12	RD-12-S-P30-F
RD-04-S	RD-04-S-P30-F-N	RD-06-NP	RD-06-S-P30-F-N	RD-12-NP	RD-12-S-P30-F-N
RD-04-S-NP	RD-04-S-P45-F	RD-06-S	RD-06-S-P45-F	RD-12-S	RD-12-S-P45-F
RD-04-S-P30	RD-04-S-P45-F-N	RD-06-S-NP	RD-06-S-P45-F-N	RD-12-S-NP	RD-12-S-P45-F-N
		RD-06-S-P30		RD-12-S-P30	

How To Specify

RD-XX - X - Nozzle

Nozzle
See Rotary Nozzle, U-Series, MPR, VAN, HE-VAN and SQ Nozzle specifications for more information

Optional Features

S: Seal-A-Matic™ check valve
P30: 30 psi (2.1 bar) in-stem pressure regulation
P45: 45 psi (3.1 bar) in-stem pressure regulation
F: Flow-Shield™ Technology
NP: Non-potable water use indicating cover

Model

RD-04: 4" (10 cm) pop-up height
RD-06: 6" (15 cm) pop-up height
RD-12: 12" (40 cm) pop-up height

Notes:

SAM feature included with P45 models.
Flow-Shield™ Technology available in P30 and P45 models only.
Specify sprinkler bodies and nozzles separately.

1800® NP Cover

Non-Potable 1800 Spray Head Cover

Features

- Designed for excellent retention on 1800 Series Spray Body covers
- Purple plastic cover for easy identification of non-potable water system
- Marked with "Do Not Drink!" warning in both English and Spanish
- Snaps onto all 1800® Series Spray Body covers

Model

- 1800-NPCAP



1800-NPCAP

PA

Plastic Shrub Adapter

Features

- Adapts Rain Bird Nozzles for use with 1/2" (15/21) MPT threaded risers
- Accepts protective, non-clogging 1800 Series filter screen (shipped with nozzle) and PCS Series screens
- Durable, non-corrosive plastic construction
- Non-Potable Plastic Shrub Adapter

Specifications

- 1/2" (15/21) female inlet threads
- Fine top threads accept all Rain Bird nozzles

Model

- PA-8S
- PA-8S-NP



PA-8S

PA-8S-NP

PA-80

Plastic Adapter

Features

- Adapts Rain Bird Spray Bodies for use with any 1/2" (15/21) FPT bubbler or spray nozzle
- Rugged, UV-resistant thermoplastic construction
- Easy to install; no tools required

Dimensions

- Height: 1 1/2" (3.8 cm); 0.8" (2.0 cm) above 1800 cap

Model

- PA-80



PA-80

1800®-EXT

Plastic Extension

Features

- UV-resistant thermoplastic construction for long life
- Fits all Rain Bird Spray Bodies and Nozzles. Exception: Cannot be used with bubblers

Model

- 1800-EXT



1800-EXT

PA-8S-PRS

Pressure Regulating Shrub Adapter

Features

- Adapts nozzles for use with 1/2" (15/21) MPT threaded risers
- Patented PRS pressure regulator built into the stem. No parts to be installed at the site. Saves time and money
 - Maintains constant outlet pressure at 30 psi (2.1 bar). Ensures maximum spray head and nozzle performance
 - Restricts water loss by up to 70% if nozzle is removed or damaged. Saves water and money. Reduces liability. Recommended for vandal-prone areas
- Fits all Rain Bird plastic nozzles
- Rugged thermoplastic construction resists UV rays

Operating Range

- Pressure: 15 to 70 psi (1.0 to 4.8 bar)
- Flow: 0.2 to 4.0 gpm (0.05 to 0.91 m³/h; 0.06 to 15.0

Specifications

- 1/2" (15/21) female inlet threads
- Fine top threads accept all Rain Bird nozzles
- Height: 5 1/4" (13.3 cm)

Model

- PA-8S-PRS



PA-8S-PRS

1800 PCS

Pressure Compensating Screens

Features

- Compensates* for pressure variations
- Eliminates fogging and water waste caused by high pressures
- Nozzles can be matched with screens to create short-throw, reduced-radius patterns and/or flush-mounted bubblers
- Color-coded for easy identification
- Use with all 1800 Series plastic nozzles (MPR, VAN, U-Series, Strips and Bubblers)

Operating Range

- Flow: 0.20 to 0.90 gpm (0.05 to 0.20 m³/h; 0.6 to 3.6 l/m)
- Pressure: 15 to 70 psi (1.0 to 4.8 bar)

Models

- PCS-020: 0.2 gpm (0.05 m³/h; 0.6 l/m) - Brown
- PCS-025: 0.25 gpm (0.06 m³/h; 1.2 l/m) - Pink
- PCS-030: 0.3 gpm (0.07 m³/h; 1.2 l/m) - Silver
- PCS-040: 0.4 gpm (0.09 m³/h; 1.8 l/m) - Orange
- PCS-060: 0.6 gpm (0.14 m³/h; 2.4 l/m) - Black
- PCS-090: 0.9 gpm (0.20 m³/h; 3.6 l/m) - White

* With a pressure compensator, outlet pressure will be reduced, but will fluctuate as the inlet pressure changes. A pressure compensator cannot maintain outlet pressure at a constant rate. A pressure regulator establishes and maintains a constant outlet pressure of 30 psi (2.1 bar) as long as the inlet pressure at the spray head is greater than 30 psi (2.1 bar)



1800 PCS
Screens

1800 PCS Performance

Flow (gpm) m ³ /h (l/m)	PCS-020 0.2 0.05 (60) Brown		PCS-025 0.25 0.06 (72) Pink		PCS-030 0.3 0.07 (84) Silver		PCS-040 0.4 0.09 (108) Orange		PCS-060 0.6 0.14 (144) Black		PCS-090 0.9 0.20 (216) White	
	Distance	feet	meters	feet	meters	feet	meters	feet	meters	feet	meters	feet
U-8Q	6	(1.8)	7	(2.1)								
U-8T	4	(1.2)	5	(1.5)								
U-8H	4	(1.2)	5	(1.5)								
U-8F					1	(0.3)	3	(0.9)	7	(2.1)		
U-10Q	5	(1.5)	6	(1.8)	10'	(3.1)						
U-10T	4	(1.2)	4	(1.2)	8	(2.4)	10'	(3.1)				
U-10H					5	(1.5)	6	(1.8)	8	(2.4)	9	(2.7)
U-10F									4	(1.2)	9	(2.7)
U-12Q	2'	(0.6)	4	(1.2)	7'	(2.1)	12'	(3.7)				
U-12T			2	(0.6)	6'	(1.8)	8'	(2.4)	12'	(3.7)		
U-12H					3'	(0.9)	4'	(1.2)	7'	(2.1)	11'	(3.4)
U-12TT									6'	(1.8)	9'	(2.7)
U-12TQ									5'	(1.5)	8'	(2.4)
U-12F							3'	(0.9)	6'	(1.8)	8'	(2.4)
U-15Q			3'	(0.9)	6'	(1.8)	11'	(3.4)	15'	(4.6)		
U15T									10'	(3.1)	13'	(4.0)
U-15H					2'	(0.6)	3'	(0.9)	5'	(1.5)	9'	(2.7)
U15TT												
U15TQ												
U-15F									4'	(1.2)	6'	(1.8)
4 (90°)	1'	(0.3)			3'	(0.9)	4'	(1.2)				
4 (180°)			1'	(0.3)	2'	(0.6)	3'	(0.9)	4'	(1.2)		
4 (270°)					1'	(0.3)	2'	(0.6)	4'	(1.2)		
4 (330°)					1'	(0.3)	2'	(0.6)	4'	(1.2)		
6 (90°)			2'	(0.6)	3'	(0.9)	6'	(1.8)				
6 (180°)					2'	(0.6)	4'	(1.2)	6'	(1.8)		
6 (270°)					0.5'	(0.2)	1'	(0.3)	3'	(0.9)	6'	(1.8)
6 (330°)					0.5'	(0.2)	1'	(0.3)	3'	(0.9)	6'	(1.8)
8 (90°)					1'	(0.3)	3'	(0.9)	8'	(2.4)		
8 (180°)					0.5'	(0.2)	2'	(0.6)	4'	(1.2)	8'	(2.4)
8 (270°)							0.5'	(0.2)	3'	(0.9)	5'	(1.5)
8 (330°)							0.5'	(0.2)	3'	(0.9)	5'	(1.5)
10 (90°)					3'	(0.9)	5'	(1.5)	10'	(3.1)		
10 (180°)							1'	(0.3)	5'	(1.5)	7'	(2.1)
10 (270°)							1'	(0.3)	4'	(1.2)	6'	(1.8)
10 (360°)					0.5'	(0.2)	1'	(0.3)	4'	(1.2)	6'	(1.8)
12 (90°)	3'	(0.9)			8'	(2.4)	10'	(3.1)	12'	(3.7)		
12 (180°)					1'	(0.3)	2'	(0.6)	5'	(1.5)	8'	(2.4)
12 (270°)					0.5'	(0.2)	1'	(0.3)	3'	(0.9)	6'	(1.8)
12 (360°)							1'	(0.3)	3'	(0.9)	5'	(1.5)
15 (90°)					2'	(0.6)	5'	(1.5)	11'	(3.4)	15'	(4.6)
15 (180°)					1'	(0.3)	3'	(0.9)	6'	(1.8)	9'	(2.7)
15 (270°)											6'	(1.8)
15 (360°)												
18 (90°)					0.5'	(0.2)	2'	(0.6)	6'	(1.8)	12'	(3.7)
18 (180°)							1'	(0.3)	3'	(0.9)	5'	(1.5)
18 (270°)							0.5'	(0.2)	1'	(0.3)	3'	(0.9)
18 (330°)							0.5'	(0.2)	1'	(0.3)	3'	(0.9)

Bold green type indicates recommended nozzle/screen combination to achieve catalog performance at 30 psi (2.1 bar)

Bold blue type indicates satisfactory nozzle/screen combination

Black type indicates a nozzle/screen combination that provides a throw reduction of more than 50%. With these nozzle/screen combinations a uniform spray pattern is not assured and a bubbler effect may result

Note: Screens were tested at 50 psi (3.5 bar) for 10 minutes prior to taking distance measurements. Distances may vary slightly with higher pressures and longer run-times
Note: Refer to catalog notation for proper nozzle selection

1800 PCS Performance

Flow (gpm) m ³ /h (l/m)	PCS-020 0.2 0.05 (60) Brown		PCS-025 0.25 0.06 (72) Pink		PCS-030 0.3 0.07 (84) Silver		PCS-040 0.4 0.09 (108) Orange		PCS-060 0.6 0.14 (144) Black		PCS-090 0.9 0.20 (216) White		
	Distance	feet	meters	feet	meters	feet	meters	feet	meters	feet	meters	feet	meters
5Q													
5T													
5H	5'	(1.5)	6'	(1.8)									
5F					5'	(1.5)							
8Q	8'	(2.4)	10'	(3.1)									
8T	6'	(1.8)	6.5'	(2.0)	7'	(2.1)	8'	(2.4)					
8H	5'	(1.5)	6'	(1.8)	7'	(2.1)	8'	(2.4)					
8F					2'	(0.6)	3'	(0.9)	8'	(2.4)			
10Q	6'	(1.8)	8'	(2.4)	8'	(2.4)	10'	(3.1)					
10T	4'	(1.2)	5'	(1.5)	9'	(2.7)	10'	(3.1)					
10H	3'	(0.9)	4'	(1.2)	6'	(1.8)	8'	(2.4)	10'	(3.1)			
10F							1'	(0.3)	4'	(1.2)	8'	(2.4)	
12Q	3'	(0.9)	7'	(2.1)	8'	(2.4)	11'	(3.4)	12'	(3.7)			
12T	2'	(0.6)	4'	(1.2)	6'	(1.8)	10'	(3.1)	11'	(3.4)	12'	(3.7)	
12H					4'	(1.2)	6'	(1.8)	10'	(3.1)	12'	(3.7)	
12TT					2'	(0.6)	4'	(1.2)	6'	(1.8)	9'	(2.7)	
12TQ					2'	(0.6)	3'	(0.9)	6'	(1.8)	8'	(2.4)	
12F							2'	(0.6)	5'	(1.5)	7'	(2.1)	
15Q	3'	(0.9)	4'	(1.2)	5'	(1.5)	9'	(2.7)	12'	(3.7)	15'	(4.6)	
15T			2'	(0.6)	5'	(1.5)	7'	(2.1)	12'	(3.7)	14'	(4.3)	
15H					3'	(0.9)	4'	(1.2)	7'	(2.1)	11'	(3.4)	
15TT					1'	(0.3)	2'	(0.6)	4'	(1.2)	8'	(2.4)	
15TQ											6'	(1.8)	
15F											4'	(1.2)	
5Q-B	2'	(0.6)	3	(0.9)	4'	(1.2)	5'	(1.5)					
5H-B					1'	(0.3)	2'	(0.6)	5'	(1.5)			
5F-B							1'	(0.3)	2'	(0.6)	3'	(0.9)	
5CST-B	1'	(0.3)	2	(0.6)	3'	(0.9)	5'	(1.5)					
9SST												7' x 12'	(2.1 x 3.7)
15CST								4' x 12'	(1.2 x 3.7)	4' x 24'	(1.2 x 7.3)	4' x 30'	(1.2 x 9.1)
15SST								2' x 10'	(0.6 x 3.1)	3' x 20'	(0.9 x 6.1)	4' x 26'	(1.2 x 7.9)
15EST						3' x 12'	(0.9 x 3.7)	4' x 15'	(1.2 x 4.6)				
15LCS	1' x 5'	(0.3 x 1.5)	1' x 7'	(0.3 x 2.1)	1' x 12'	(0.3 x 3.7)							
15RCS	1' x 5'	(0.3 x 1.5)	1' x 7'	(0.3 x 2.1)	1' x 12'	(0.3 x 3.7)							

Bold green type indicates recommended nozzle/screen combination to achieve catalog performance at 30 psi (2.1 bar)

Bold blue type indicates satisfactory nozzle/screen combination

Black type indicates a nozzle/screen combination that provides a throw reduction of more than 50%. With these nozzle/screen combinations a uniform spray pattern is not assured and a bubbler effect may result

Note: Screens were tested at 50 psi (3.5 bar) for 10 minutes prior to taking distance measurements. Distances may vary slightly with higher pressures and longer run-times

Note: Refer to catalog notation for proper nozzle selection

SA Series

Swing Assemblies Connect Heads to Lateral Pipes.

Features

- Quality alternative to locally assembled swing pipe/spiral barb fittings that do not carry a manufacturer's warranty
- Comprehensive range of products support a variety of landscape solutions
- Complementary engineered fittings and spray heads instill confidence in product specification

Specifications

- The operating range of the Rain Bird Swing Assemblies matches or exceeds the operating range for most 1/2" (1.3 cm) sprays and 3/4" (1.9 cm) rotors
- Operating pressure: Up to 80 psi (5.5 bar)
- Surge pressure: Up to 240 psi (15.5 bar)
- Temperature: Up to 110° F (43° C)
- Maximum flow: 8 gpm (0.5 l/sec)



Unique Rain Bird system offering: Swing Assemblies and Spray Heads



SA Series

How To Specify

SA 12 5050

Inlet/Outlet
050: 1/2" x 1/2"
5050: 1/2" x 1/2"
5075: 1/2" x 3/4"
7575: 3/4" x 3/4"

Length
18"
12"
6"

Model
Swing Assembly

SA Series Swing Assemblies Specifications

Model Number	Part Number	Length		Inlet		Outlet	
		US	METRIC	US	METRIC	US	METRIC
SA-6050	A48030	6"	15.2 cm	1/2"	1.3 cm	1/2"	1.3 cm
SA-125050	A48035	12"	30.5 cm	1/2"	1.3 cm	1/2"	1.3 cm
SA-127575	A48050	12"	30.5 cm	3/4"	1.9 cm	3/4"	1.9 cm
SA-185050	A48065	18"	45.7 cm	1/2"	1.3 cm	1/2"	1.3 cm

SPX Series Swing Pipe

Swing Pipe with Spiral Barb Fittings Provides a Flexible Swing Assembly for Sprays and Rotors

Features and Benefits

- **SPX-FLEX100**
 - Superior flexibility allows pipe to be efficiently routed around hardscape, terraces, and uneven terrain to turn landscape design into reality
 - Textured surface makes product easier to handle, contributing to labor efficiency, especially under wet conditions
 - Up to 30% more flexible than competitive flexible pipe*
 - Resists kinking
 - Quick and easy installation lowers material and labor costs
 - Installs quickly leaving time for additional system installations and incremental revenue opportunities

**Based on tests conducted at the Rain Bird Product Research Center. Tests conducted on Rain Bird and principal competitors' swing pipe*

Specifications

- Inside diameter: 0.49" (1.24 cm)
- Operating pressure: Up to 80 psi (5.5 bar)
- Temperature: Up to 110° F (43° C)

Models

- SPX-FLEX-100: 100' (30 m) coil
- SPX-FLX-330: 330' (100 m) coil



Up to 30% more flexible
than competitors



SPX-FLEX100

SB Series Spiral Barb Fittings

A Natural Product Complement to SPX Series Swing Pipe

Features and Benefits

- Fittings are made of robust acetal material to make connecting swing pipe fast and easy
- Easy twist-in insertion – no glue or clamps needed for installation
- Aggressive barb lip makes a secure connection that is less likely to leak

- Broad range of shapes and sizes allow the contractor to choose the best fitting for the application
- Extended length and aggressive barb lip prevent blow outs, reducing likelihood of contractor call backs

Specifications

- Operating pressure: Up to 80 psi (5.5 bar)
- Temperature: Up to 110° F (43° C)

Models

- SBE-050: 1/2" M NPT x 1/2" barb elbow
- SBE-075: 3/4" M NPT x 1/2" barb elbow
- SBA-050: 1/2" M NPT x 1/2" barb adapter
- SB-TEE: 1/2" barb x 1/2" barb x 1/2" barb tee
- SB-CPLG: 1/2" barb x 1/2" barb coupling



Spray Nozzles

Introduction

Spray Nozzles

Spray Nozzles

Rotors

Valves

Controllers

Central Controls

Landscape Drip

Pumps

Drainage Products

Resources



"The beauty of the HE-VAN is that with one simple change we got a lot of benefits, like saving money, water, and time. We also anticipate decreased liability and reduced system wear and tear. Now we can confidently meet industry regulations and environmental challenges while providing a lush landscape that all can enjoy. That's a lot of payback for just changing a nozzle!"

*Brian Baker, Landscape/Irrigation Engineer
FLAGLER*

Major Products

Primary Applications	Fixed ARC Sprays			Variable ARC Sprays		Rotary Nozzles	
	MPR Standard	SQ Nozzles Standard	U-Series Better	VAN Standard	HE-VAN Best	Rotary Standard	R-VAN Best
Turfgrass	●	●	●	●	●	●	●
Slopes						●	●
Narrow Strips	●	●					
Small Areas		●					
Landscape Beds	●	●	●	●	●	●	●
High Efficiency			●		●	●	●
High Winds			●		●	●	●
High Pressure					●	●	●



Water Saving Tips

- U-Series Nozzles are dual-orifice nozzles that have better, more uniform water distribution. Water flowing from both orifices combines to form a continuous water stream and eliminates gaps for more uniform coverage throughout the entire watering area.
- HE-VAN nozzles are fully adjustable from 0 to 360 degrees with high uniformity and efficiency. HE-VAN nozzles can reduce the number of variations that need to be carried to cover just about any field challenge. Available in radii from 8' to 15', this high efficient nozzle has you covered.
- Rotary Nozzles have efficient water distribution through rotating streams that uniformly deliver water at a low precipitation rate, significantly reducing runoff and erosion.

Plastic MPR Nozzles

Matched Precipitation Rate Nozzles

Features

- Matched precipitation rates across sets and patterns in 5 Series, 8 Series, 10 Series, 12 Series, and 15 Series for even water distribution and design flexibility
- MPR Nozzles are installed by more contractors than all other brands combined
- Quickly identify radius and arc with Top Color-coded™ nozzles even when system is not operating
- Three year trade warranty

Operating Range

- Spacing: 3 to 15 feet (0.9 to 4.6 m)¹
- Pressure: 15 to 30 psi (1 to 2.1 bar)
- Optimum pressure: 30 psi (2.1 bar)²



Rain Bird® MPR Nozzles, The Industry Standard

Models

- 5 Series: Quarter, Half, Full Nozzles
- 5 Series: Bubbler Nozzles
- 8 Series: Quarter, Half, Full Nozzles
- 8 FLT Series: Designed for lower trajectory applications, such as windy areas
- 10 Series Nozzles
- 12 Series Nozzles
- 15 Series: Quarter, Half, Full Nozzles
- 15 Strip Series Nozzles

¹ These ranges are based on proper pressure at nozzle.

² Rain Bird recommends using 1800 PRS Spray Bodies to maintain optimum nozzle performance in higher pressure situations.





MPR Nozzle and Screen

How To Specify



5 F

Pattern
F: Full
H: Half
Q: Quarter

MPR Radius Range
5: 5 feet (1.5 m)
8: 8 feet (2.4 m)
12: 12 feet (3.7 m)
15: 15 feet (4.6 m)

5 Series MPR						
5° Trajectory						
Nozzle	Pressure psi	Radius ft.	Flow gpm	■ Precip In/h	▲ Precip In/h	
5F 	15	3	0.29	3.10	3.58	
	20	4	0.33	1.99	2.29	
	25	4	0.37	2.23	2.57	
	30	5	0.41	1.58	1.83	
5H 	15	3	0.14	3.00	3.46	
	20	4	0.16	1.93	2.22	
	25	4	0.18	2.17	2.50	
	30	5	0.20	1.54	1.78	
5Q 	15	3	0.07	3.00	3.46	
	20	4	0.08	1.93	2.22	
	25	4	0.09	2.17	2.50	
	30	5	0.10	1.54	1.78	



Note: All MPR nozzles tested on 4" (10.2 cm) pop-ups
■ Square spacing based on 50% diameter of throw
▲ Triangular spacing based on 50% diameter of throw



5 Series MPR							METRIC	
5° Trajectory								
Nozzle	Pressure bar	Radius m	Flow m ³ /h	Flow l/m	■ Precip mm/h	▲ Precip mm/h		
5F 	1.0	1.1	0.06	1.1	79	91		
	1.5	1.3	0.08	1.4	51	58		
	2.0	1.5	0.09	1.6	57	65		
	2.1	1.5	0.09	1.6	40	46		
5H 	1.0	1.1	0.03	0.5	76	88		
	1.5	1.3	0.04	0.7	49	56		
	2.0	1.5	0.04	0.7	55	64		
	2.1	1.5	0.05	0.9	39	45		
5Q 	1.0	1.1	0.02	0.4	76	88		
	1.5	1.3	0.02	0.4	49	56		
	2.0	1.5	0.02	0.4	55	64		
	2.1	1.5	0.02	0.4	39	45		



Performance data taken in zero wind conditions



Note: Specify spray body and nozzles separately.



Note: Radius reduction over 25% of the normal throw of the nozzle is not recommended



8 Series MPR					
10° Trajectory					
Nozzle	Pressure psi	Radius ft.	Flow gpm	■ Precip In/h	▲ Precip In/h
8F 	15	5	0.74	2.85	3.29
	20	6	0.86	2.30	2.66
	25	7	0.96	1.89	2.18
	30	8	1.05	1.58	1.82
8H 	15	5	0.37	2.85	3.29
	20	6	0.42	2.25	2.59
	25	7	0.47	1.85	2.13
	30	8	0.52	1.56	1.81
8Q 	15	5	0.18	2.77	3.20
	20	6	0.21	2.25	2.59
	25	7	0.24	1.89	2.18
	30	8	0.26	1.56	1.81

8 Series MPR						METRIC	
10° Trajectory							
Nozzle	Pressure bar	Radius m	Flow m³/h	Flow l/m	■ Precip mm/h	▲ Precip mm/h	
8F 	1.0	1.7	0.16	2.8	72	84	
	1.5	2.1	0.20	3.4	58	68	
	2.0	2.4	0.23	3.9	48	55	
	2.1	2.4	0.24	4.0	40	46	
8H 	1.0	1.7	0.08	1.4	72	84	
	1.5	2.1	0.10	1.7	57	66	
	2.0	2.4	0.12	1.9	47	54	
	2.1	2.4	0.12	2.0	40	46	
8Q 	1.0	1.7	0.04	0.7	70	81	
	1.5	2.1	0.05	0.8	57	66	
	2.0	2.4	0.06	1.0	48	55	
	2.1	2.4	0.06	1.0	40	46	

10 Series MPR					
15° Trajectory					
Nozzle	Pressure psi	Radius ft.	Flow gpm	■ Precip In/h	▲ Precip In/h
10F 	15	7	1.16	2.28	2.63
	20	8	1.30	1.96	2.26
	25	9	1.44	1.71	1.98
	30	10	1.58	1.52	1.75
10H 	15	7	0.58	2.28	2.63
	20	8	0.65	1.96	2.26
	25	9	0.72	1.71	1.98
	30	10	0.79	1.52	1.75
10Q 	15	7	0.29	2.28	2.63
	20	8	0.33	1.96	2.26
	25	9	0.36	1.71	1.98
	30	10	0.39	1.52	1.75



10 Series MPR						METRIC	
15° Trajectory							
Nozzle	Pressure bar	Radius m	Flow m³/h	Flow l/m	■ Precip mm/h	▲ Precip mm/h	
10F 	1.0	2.1	0.26	4.2	58	67	
	1.5	2.4	0.29	4.8	50	58	
	2.0	3.0	0.35	6.0	39	45	
	2.1	3.1	0.36	6.0	37	43	
10H 	1.0	2.1	0.13	2.4	58	67	
	1.5	2.4	0.14	2.4	50	58	
	2.0	3.0	0.18	3.0	39	45	
	2.1	3.1	0.18	3.0	37	43	
10Q 	1.0	2.1	0.06	1.2	58	67	
	1.5	2.4	0.07	1.2	50	58	
	2.0	3.0	0.09	1.2	39	45	
	2.1	3.1	0.09	1.2	37	43	

12 Series MPR					
30° Trajectory					
Nozzle	Pressure psi	Radius ft.	Flow gpm	■ Precip In/h	▲ Precip In/h
12F 	15	9	1.80	2.14	2.47
	20	10	2.10	2.02	2.34
	25	11	2.40	1.91	2.21
	30	12	2.60	1.74	2.01
12H 	15	9	0.90	2.14	2.47
	20	10	1.05	2.02	2.34
	25	11	1.20	1.91	2.21
	30	12	1.30	1.74	2.01
12Q 	15	9	0.45	2.14	2.47
	20	10	0.53	2.02	2.34
	25	11	0.60	1.91	2.21
	30	12	0.65	1.74	2.01



12 Series MPR						METRIC	
30° Trajectory							
Nozzle	Pressure bar	Radius m	Flow m³/h	Flow l/m	■ Precip mm/h	▲ Precip mm/h	
12F 	1.0	2.7	0.40	6.8	55	63	
	1.5	3.2	0.48	8.3	47	54	
	2.0	3.6	0.59	9.7	46	53	
	2.1	3.7	0.60	9.8	44	51	
12H 	1.0	2.7	0.20	3.4	55	63	
	1.5	3.2	0.24	4.2	47	54	
	2.0	3.6	0.30	4.9	46	53	
	2.1	3.7	0.30	4.9	44	51	
12Q 	1.0	2.7	0.10	1.7	55	63	
	1.5	3.2	0.12	2.1	47	54	
	2.0	3.6	0.15	2.4	46	53	
	2.1	3.7	0.15	2.5	44	51	

Note: All MPR nozzles tested on 4" (10.2 cm) pop-ups
 ■ Square spacing based on 50% diameter of throw
 ▲ Triangular spacing based on 50% diameter of throw





Performance data taken in zero wind conditions
Note: Specify spray body and nozzles separately.
Note: Radius reduction over 25% of the normal throw of the nozzle is not recommended

15 Series MPR					
30° Trajectory					
Nozzle	Pressure psi	Radius ft.	Flow gpm	Precip In/h	Precip In/h
15F 	15	11	2.60	2.07	2.39
	20	12	3.00	2.01	2.32
	25	14	3.30	1.62	1.87
	30	15	3.70	1.58	1.83
15H 	15	11	1.30	2.07	2.39
	20	12	1.50	2.01	2.32
	25	14	1.65	1.62	1.87
	30	15	1.85	1.58	1.83
15Q 	15	11	0.65	2.07	2.39
	20	12	0.75	2.01	2.32
	25	14	0.82	1.62	1.87
	30	15	0.92	1.58	1.83





Note: All MPR nozzles tested on 4" (10.2 cm) pop-ups
 ■ Square spacing based on 50% diameter of throw
 ▲ Triangular spacing based on 50% diameter of throw







15 Series MPR					METRIC	
30° Trajectory						
Nozzle	Pressure bar	Radius m	Flow m ³ /h	Flow l/m	Precip mm/h	Precip mm/h
15F 	1.0	3.4	0.60	9.8	52	60
	1.5	3.9	0.72	11.8	47	55
	2.0	4.5	0.84	13.7	41	48
	2.1	4.6	0.84	14.0	40	46
15H 	1.0	3.4	0.30	4.9	52	60
	1.5	3.9	0.36	5.9	47	55
	2.0	4.5	0.42	6.8	41	48
	2.1	4.6	0.42	7.0	40	46
15Q 	1.0	3.4	0.15	2.5	52	60
	1.5	3.9	0.18	2.9	47	55
	2.0	4.5	0.21	3.4	41	48
	2.1	4.6	0.21	3.5	40	46

Performance data taken in zero wind conditions
Note: Specify spray body and nozzles separately.
Note: Radius reduction over 25% of the normal throw of the nozzle is not recommended

5 Series MPR Stream Bubbler Nozzles			
0° Trajectory			
Nozzle	Pressure psi	Radius ft.	Flow gpm
5F-B 	15	5	1.50
	20	5	1.50
	25	5	1.50
	30	5	1.50
5H-B 	15	5	1.00
	20	5	1.00
	25	5	1.00
	30	5	1.00
5Q-B 	15	5	0.50
	20	5	0.50
	25	5	0.50
	30	5	0.50
5CST-B 	15	5	0.50
	20	5	0.50
	25	5	0.50
	30	5	0.50

Note: Indicates adjusted radius at psi shown
Note: Flow at adjusted radius of 5 feet (1.5 m)







5 Series MPR Stream Bubbler Nozzles				METRIC
0° Trajectory				
Nozzle	Pressure bar	Radius m	Flow m ³ /h	Flow l/m
5F-B 	1.0	1.5	0.35	5.7
	1.5	1.5	0.35	5.7
	2.0	1.5	0.35	5.7
	2.1	1.5	0.35	5.7
5H-B 	1.0	1.5	0.23	3.8
	1.5	1.5	0.23	3.8
	2.0	1.5	0.23	3.8
	2.1	1.5	0.23	3.8
5Q-B 	1.0	1.5	0.12	1.9
	1.5	1.5	0.12	1.9
	2.0	1.5	0.12	1.9
	2.1	1.5	0.12	1.9
5CST-B 	1.0	1.5	0.12	1.9
	1.5	1.5	0.12	1.9
	2.0	1.5	0.12	1.9
	2.1	1.5	0.12	1.9

15 Strip Series			
30° Trajectory			
Nozzle	Pressure psi	W x L ft.	Flow gpm
 15EST	15	4 x 13	0.45
	20	4 x 14	0.50
	25	4 x 14	0.56
	30	4 x 15	0.61
 15CST	15	4 x 26	0.89
	20	4 x 28	1.00
	25	4 x 28	1.11
	30	4 x 30	1.21
 15RCS	15	3 x 11	0.35
	20	3 x 12	0.40
	25	4 x 14	0.45
	30	4 x 15	0.49
 15LCS	15	3 x 11	0.35
	20	3 x 12	0.40
	25	4 x 14	0.45
	30	4 x 15	0.49
 15SST	15	4 x 26	0.89
	20	4 x 28	1.00
	25	4 x 28	1.11
	30	4 x 30	1.21
 9SST	15	9 x 15	1.34
	20	9 x 16	1.47
	25	9 x 18	1.60
	30	9 x 18	1.73



W = Width of coverage pattern L = Length of coverage pattern

Note: Specify spray body and nozzles separately.

Note: Radius reduction over 25% of the normal throw of the nozzle is not recommended

15 Strip Series				METRIC
30° Trajectory				
Nozzle	Pressure bar	W x L m	Flow m ³ /h	Flow l/m
 15EST	1.0	1.2 x 4.0	0.10	1.7
	1.5	1.2 x 4.3	0.11	2.0
	2.0	1.2 x 4.3	0.13	2.3
	2.1	1.2 x 4.6	0.14	2.3
	2.1	1.2 x 4.6	0.14	2.3
 15CST	1.0	1.2 x 7.9	0.20	3.4
	1.5	1.2 x 8.5	0.23	4.0
	2.0	1.2 x 8.5	0.25	4.5
	2.1	1.2 x 9.2	0.27	4.6
	2.1	1.2 x 9.2	0.27	4.6
 15RCS	1.0	0.8 x 3.2	0.08	1.3
	1.5	1.0 x 3.9	0.09	1.6
	2.0	1.2 x 4.5	0.11	1.8
	2.1	1.2 x 4.6	0.11	1.9
	2.1	1.2 x 4.6	0.11	1.9
 15LCS	1.0	0.8 x 3.2	0.08	1.3
	1.5	1.0 x 3.9	0.09	1.6
	2.0	1.2 x 4.5	0.11	1.8
	2.1	1.2 x 4.6	0.11	1.9
	2.1	1.2 x 4.6	0.11	1.9
 15SST	1.0	1.2 x 7.9	0.20	3.4
	1.5	1.2 x 8.5	0.23	4.0
	2.0	1.2 x 8.5	0.25	4.5
	2.1	1.2 x 9.2	0.27	4.6
	2.1	1.2 x 9.2	0.27	4.6
 9SST	1.0	2.7 x 4.6	0.30	5.1
	1.5	2.7 x 4.9	0.33	5.8
	2.0	2.7 x 5.5	0.36	6.5
	2.1	2.7 x 5.5	0.39	6.5
	2.1	2.7 x 5.5	0.39	6.5



Performance data taken in zero wind conditions

8 FLT Series MPR					
5° Trajectory					
Nozzle	Pressure psi	Radius ft.	Flow gpm	■ Precip In/h	▲ Precip In/h
 8H-FLT	15	6	0.56	3.36	3.88
	20	7	0.65	2.91	3.36
	25	7	0.72	2.60	3.01
	30	8	0.79	2.38	2.75
 8Q-FLT	15	6	0.28	3.32	3.83
	20	7	0.32	2.87	3.32
	25	7	0.36	2.57	2.97
	30	8	0.39	2.35	2.71

Note: All MPR nozzles tested on 4" (10.2 cm) pop-ups

■ Square spacing based on 50% diameter of throw

▲ Triangular spacing based on 50% diameter of throw

8 FLT Series MPR						METRIC
5° Trajectory						
Nozzle	Pressure bar	Radius m	Flow m ³ /h	Flow l/m	■ Precip mm/h	▲ Precip mm/h
 8H-FLT	1.0	1.7	0.12	2.1	87	101
	1.5	2.1	0.15	2.6	71	82
	2.0	2.4	0.18	2.9	62	71
	2.1	2.4	0.18	3.0	60	70
	2.1	2.4	0.18	3.0	60	70
 8Q-FLT	1.0	1.7	0.06	1.1	86	100
	1.5	2.1	0.07	1.3	71	81
	2.0	2.4	0.09	1.4	61	71
	2.1	2.4	0.09	1.5	60	69
	2.1	2.4	0.09	1.5	60	69

Performance data taken in zero wind conditions

Note: Specify spray body and nozzles separately.

Note: Radius reduction over 25% of the normal throw of the nozzle is not recommended

Plastic U-Series Nozzles

Dual orifice spray nozzles that use 30% less water¹

Features

- Additional orifice for close-in watering minimizes brown spots around the spray head and eliminates gaps in coverage so the entire watering area is more uniformly covered
- Low scheduling coefficient for efficient watering. Use up to 30% less water²
- Matched precipitation rate between sets and matched flow (gpm, m³/h and l/m) and precipitation rates with Rain Bird MPR Nozzles
- Five year trade warranty

Operating Range

- Spacing: 5 to 15 feet (1.8 to 4.6 m)³
- Pressure: 15 to 30 psi (1.0 to 2.1 bar)
- Optimum pressure: 30 psi (2.1 bar)⁴



U-Series Nozzle with screen

Models

- U-8 Series: 8-foot Quarter, Third, Half, Full nozzles
- U-10 Series: 10-foot Quarter, Third, Half, Full nozzles
- U-12 Series: 12-foot Quarter, Third, Half, Two-thirds, Three-quarters, Full nozzles
- U-15 Series: 15-foot Quarter, Third, Half, Two-thirds, Three-quarters, Full nozzles

¹ When U-Series dual-orifice nozzles are installed instead of standard nozzles on every spray body in the zone. Results may vary based on site-specific conditions such as sprinkler spacing, wind, temperature, soil and grass type

² Scheduling Coefficient (SC) measures the efficiency of spray heads. SC measures how much more you must water your ENTIRE area for the driest sections to receive sufficient water. The lower the SC, the better the spray heads distribute water

³ These ranges are based on proper pressure at nozzle.

⁴ Rain Bird recommends using 1800 PRS Spray Bodies to maintain optimum nozzle performance in higher pressure situations.

Stainless steel adjustment screw to adjust flow and radius

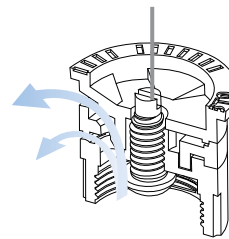

Fits all Rain Bird Spray Bodies and Shrub Adapters

How To Specify

U12H

Pattern
F: Full
H: Half
Q: Quarter
T: One-third
TT: Two-thirds
TQ: Three-quarter

Radius Range
8: 8 feet (2.4 m)
12: 12 feet (3.7 m)
15: 15 feet (4.6 m)

Model
U-Series Nozzle

U8 Series					
10° Trajectory					
Nozzle	Pressure psi	Radius ft.	Flow gpm	Precip In/h	Precip In/h
U-8F	15	5	0.74	2.85	3.29
	20	6	0.86	2.30	2.66
	25	7	0.96	1.89	2.18
	30	8	1.05	1.58	1.83
U8H	15	5	0.37	2.85	3.29
	20	6	0.42	2.25	2.59
	25	7	0.47	1.85	2.13
	30	8	0.52	1.58	1.83
U8T	15	5	0.25	2.89	3.34
	20	6	0.29	2.33	2.69
	25	7	0.32	1.89	2.18
	30	8	0.35	1.58	1.83
U8Q	15	5	0.18	2.77	3.20
	20	6	0.21	2.25	2.59
	25	7	0.24	1.89	2.18
	30	8	0.26	1.58	1.83

Note: All U-Series nozzles tested on 4" (10.2 cm) pop-ups





■ Square spacing based on 50% diameter of throw





▲ Triangular spacing based on 50% diameter of throw







U8 Series					METRIC	
10° Trajectory						
Nozzle	Pressure bar	Radius m	Flow m ³ /h	Flow l/m	Precip mm/h	Precip mm/h
U-8F	1.0	1.7	0.16	2.8	72	84
	1.5	2.1	0.20	3.4	58	68
	2.0	2.4	0.23	3.9	48	55
	2.1	2.4	0.24	4.0	40	46
U-8H	1.0	1.7	0.08	1.4	72	84
	1.5	2.1	0.10	1.7	57	66
	2.0	2.4	0.12	1.9	47	54
	2.1	2.4	0.12	2.0	40	46
U-8T	1.0	1.7	0.05	0.9	73	85
	1.5	2.1	0.07	1.1	59	68
	2.0	2.4	0.08	1.3	48	55
	2.1	2.4	0.08	1.3	40	46
U-8Q	1.0	1.7	0.04	0.7	70	81
	1.5	2.1	0.05	0.8	57	66
	2.0	2.4	0.06	1.0	48	55
	2.1	2.4	0.06	1.0	40	46







Performance data taken in zero wind conditions

Radius refers to recommended product spacing. Actual radii along arc may vary

U10 Series					
12° Trajectory					
Nozzle	Pressure psi	Radius ft.	Flow gpm	■ Precip In/h	▲ Precip In/h
 U-10F	15	7	1.16	2.07	2.39
	20	8	1.34	2.01	2.32
	25	9	1.50	1.62	1.87
	30	10	1.64	1.58	1.83
 U-10H	15	7	0.58	2.07	2.39
	20	8	0.67	2.01	2.32
	25	9	0.75	1.62	1.87
	30	10	0.82	1.58	1.83
 U-10T	15	7	0.39	2.07	2.39
	20	8	0.45	2.01	2.32
	25	9	0.50	1.62	1.87
	30	10	0.55	1.58	1.83
 U-10Q	15	7	0.29	2.07	2.39
	20	8	0.33	2.01	2.32
	25	9	0.37	1.62	1.87
	30	10	0.41	1.58	1.83

U10 Series					METRIC	
12° Trajectory						
Nozzle	Pressure bar	Radius m	Flow m ³ /h	Flow l/m	■ Precip mm/h	▲ Precip mm/h
 U-10F	1.0	2.1	0.26	4.4	52	60
	1.5	2.6	0.30	5.3	47	55
	2.0	3.0	0.34	6.1	41	48
	2.1	3.1	0.37	6.2	40	46
	2.1	3.1	0.37	6.2	40	46
 U-10H	1.0	2.1	0.13	2.2	52	60
	1.5	2.6	0.15	2.6	47	55
	2.0	3.0	0.17	3.1	41	48
	2.1	3.1	0.19	3.1	40	46
	2.1	3.1	0.19	3.1	40	46
 U-10T	1.0	2.1	0.09	1.5	52	60
	1.5	2.6	0.10	1.8	47	55
	2.0	3.0	0.11	2.0	41	48
	2.1	3.1	0.12	2.1	40	46
	2.1	3.1	0.12	2.1	40	46
 U-10Q	1.0	2.1	0.07	1.1	52	60
	1.5	2.6	0.08	1.3	47	55
	2.0	3.0	0.08	1.5	41	48
	2.1	3.1	0.09	1.6	40	46
	2.1	3.1	0.09	1.6	40	46

U12 Series					
23° Trajectory					
Nozzle	Pressure psi	Radius ft.	Flow gpm	■ Precip In/h	▲ Precip In/h
 U-12F	15	9	1.80	2.14	2.47
	20	10	2.10	2.02	2.34
	25	11	2.40	1.91	2.21
	30	12	2.60	1.74	2.01
 U-12TQ	15	9	1.35	2.14	2.47
	20	10	1.58	2.02	2.34
	25	11	1.80	1.91	2.21
	30	12	1.95	1.74	2.01
 U-12TT	15	9	1.20	2.14	2.47
	20	10	1.40	2.02	2.34
	25	11	1.60	1.91	2.21
	30	12	1.74	1.74	2.01
 U-12H	15	9	0.90	2.14	2.47
	20	10	1.05	2.02	2.34
	25	11	1.20	1.91	2.21
	30	12	1.30	1.74	2.01
 U-12T	15	9	0.60	2.14	2.47
	20	10	0.70	2.02	2.34
	25	11	0.80	1.91	2.21
	30	12	0.87	1.74	2.01
 U-12Q	15	9	0.45	2.14	2.47
	20	10	0.53	2.02	2.34
	25	11	0.60	1.91	2.21
	30	12	0.65	1.74	2.01

U12 Series					METRIC	
23° Trajectory						
Nozzle	Pressure bar	Radius m	Flow m ³ /h	Flow l/m	■ Precip mm/h	▲ Precip mm/h
 U-12F	1.0	2.7	0.40	6.8	55	63
	1.5	3.2	0.48	8.3	47	54
	2.0	3.6	0.59	9.7	46	53
	2.1	3.7	0.60	9.8	44	51
	2.1	3.7	0.60	9.8	44	51
 U-12TQ	1.0	2.7	0.30	5.1	55	63
	1.5	3.2	0.36	6.3	47	54
	2.0	3.6	0.45	7.3	46	53
	2.1	3.7	0.45	7.4	44	51
	2.1	3.7	0.45	7.4	44	51
 U-12TT	1.0	2.7	0.26	4.5	55	63
	1.5	3.2	0.32	5.6	47	54
	2.0	3.6	0.40	6.5	46	53
	2.1	3.7	0.40	6.6	44	51
	2.1	3.7	0.40	6.6	44	51
 U-12H	1.0	2.7	0.20	3.4	55	63
	1.5	3.2	0.24	4.2	47	54
	2.0	3.6	0.30	4.8	46	53
	2.1	3.7	0.30	4.9	44	51
	2.1	3.7	0.30	4.9	44	51
 U-12T	1.0	2.7	0.13	2.3	55	63
	1.5	3.2	0.16	2.8	47	54
	2.0	3.6	0.20	3.2	46	53
	2.1	3.7	0.20	3.3	44	51
	2.1	3.7	0.20	3.3	44	51
 U-12Q	1.0	2.7	0.10	1.7	55	63
	1.5	3.2	0.12	2.1	47	54
	2.0	3.6	0.15	2.4	46	53
	2.1	3.7	0.15	2.5	44	51
	2.1	3.7	0.15	2.5	44	51







Note: All U-Series nozzles tested on 4" (10.2 cm) pop-ups







■ Square spacing based on 50% diameter of throw

▲ Triangular spacing based on 50% diameter of throw

Performance data taken in zero wind conditions

Radius refers to recommended product spacing. Actual radii along arc may vary

U15 Series					
23° Trajectory					
Nozzle	Pressure psi	Radius ft.	Flow gpm	Precip In/h	Precip In/h
U-15F 	15	11	2.60	2.07	2.39
	20	12	3.00	2.01	2.32
	25	14	3.30	1.62	1.87
	30	15	3.70	1.58	1.83
U-15TQ 	15	11	1.95	2.07	2.39
	20	12	2.25	2.01	2.32
	25	14	2.48	1.62	1.87
	30	15	2.78	1.58	1.83
U-15TT 	15	11	1.74	2.07	2.39
	20	12	2.01	2.01	2.32
	25	14	2.21	1.62	1.87
	30	15	2.48	1.58	1.83
U-15H 	15	11	1.30	2.07	2.39
	20	12	1.50	2.01	2.32
	25	14	1.65	1.62	1.87
	30	15	1.85	1.58	1.83
U-15T 	15	11	0.87	2.07	2.39
	20	12	1.00	2.01	2.32
	25	14	1.10	1.62	1.87
	30	15	1.23	1.58	1.83
U-15Q 	15	11	0.65	2.07	2.39
	20	12	0.75	2.01	2.32
	25	14	0.82	1.62	1.87
	30	15	0.92	1.58	1.83

U15 Series					METRIC	
23° Trajectory						
Nozzle	Pressure bar	Radius m	Flow m ³ /h	Flow l/m	Precip mm/h	Precip mm/h
U-15F 	1.0	3.4	0.60	9.8	52	60
	1.5	3.9	0.72	11.8	47	55
	2.0	4.5	0.84	13.7	41	48
	2.1	4.6	0.84	14.0	40	46
U-15TQ 	1.0	3.4	0.45	7.4	52	60
	1.5	3.9	0.54	8.8	47	55
	2.0	4.5	0.63	10.3	41	48
	2.1	4.6	0.63	10.5	40	46
U-15TT 	1.0	3.4	0.40	6.6	52	60
	1.5	3.9	0.48	7.9	47	55
	2.0	4.5	0.55	9.2	41	48
	2.1	4.6	0.56	9.4	40	46
U-15H 	1.0	3.4	0.30	4.9	52	60
	1.5	3.9	0.36	5.9	47	55
	2.0	4.5	0.42	6.9	41	48
	2.1	4.6	0.42	7.0	40	46
U-15T 	1.0	3.4	0.20	3.3	52	60
	1.5	3.9	0.24	3.9	47	55
	2.0	4.5	0.28	4.6	41	48
	2.1	4.6	0.28	4.7	40	46
U-15Q 	1.0	3.4	0.15	2.5	52	60
	1.5	3.9	0.18	2.9	47	55
	2.0	4.5	0.21	3.4	41	48
	2.1	4.6	0.21	3.5	40	46

Note: All U-Series nozzles tested on 4" (10.2 cm) pop-ups

■ Square spacing based on 50% diameter of throw

▲ Triangular spacing based on 50% diameter of throw

Performance data taken in zero wind conditions

Radius refers to recommended product spacing. Actual radii along arc may vary



U-Series nozzles offer better, more uniform water distribution. Water flowing from both orifices combines to form a continuous water stream. Eliminates gaps for more uniform coverage throughout the entire watering area

VAN Series Nozzles

Variable Arc Nozzles

Features

- A simple twist of the center collar with no special tools increases or decreases the arc setting making it ideal for watering odd shaped areas
- Quickly identify radius with Top Color-coded™ nozzles even when system is not operating
- 12, 15, and 18-VAN have matched precipitation rates with Rain Bird MPR Nozzles
- Three year trade warranty

Operating Range

- Spacing: 3 to 18 feet (0.9 m to 5.5 m)¹
- Pressure: 15 to 30 psi (1.0 to 2.1 bar)
- Optimum pressure: 30 psi (2.1 bar)²

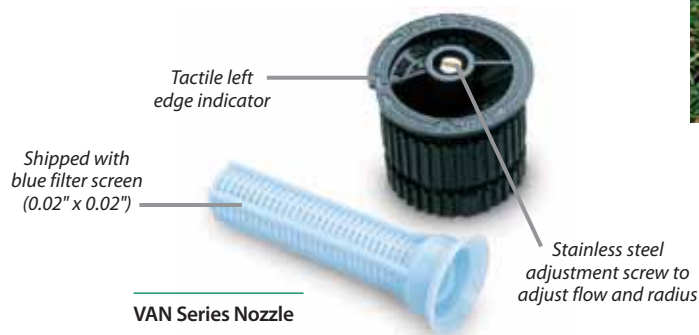

Easy to Adjust

How To Specify

8 VAN

Radius Range

- 4: 4 feet (1.2 m)
- 6: 6 feet (1.8 m)
- 8: 8 feet (2.4 m)
- 10: 10 feet (3.0 m)
- 12: 12 feet (3.7 m)
- 15: 15 feet (4.6 m)
- 18: 18 feet (5.5 m)

Nozzle Type





VAN: Variable Arc Nozzle





4 Series VAN					
0° Trajectory					
Nozzle	Pressure psi	Radius ft.	Flow gpm	■ Precip In/h	▲ Precip In/h
330° Arc	15	3	0.62	7.23	8.35
	20	3	0.70	8.17	9.43
	25	4	0.80	5.25	6.06
	30	4	0.88	5.78	6.67
270° Arc	15	3	0.52	7.42	8.57
	20	3	0.58	8.27	9.55
	25	4	0.66	5.29	6.11
180° Arc	15	3	0.32	6.84	7.90
	20	3	0.37	7.91	9.13
	25	4	0.41	4.93	5.69
90° Arc	15	3	0.21	8.98	10.37
	20	3	0.24	10.27	11.86
	25	4	0.26	6.26	7.23
	30	4	0.29	6.98	8.06





Note: All VAN nozzles tested on 4" (10.2 cm) pop-ups
 ■ Square spacing based on 50% diameter of throw
 ▲ Triangular spacing based on 50% diameter of throw





4 Series VAN					METRIC	
0° Trajectory						
Nozzle	Pressure bar	Radius m	Flow m ³ /h	Flow l/m	■ Precip mm/h	▲ Precip mm/h
330° Arc	1.0	0.9	0.14	2.3	189	218
	1.5	1.0	0.17	2.8	183	215
	2.0	1.2	0.20	3.3	152	176
	2.1	1.2	0.20	3.3	152	176
270° Arc	1.0	0.9	0.12	2.0	198	229
	1.5	1.0	0.14	2.3	187	216
	2.0	1.2	0.16	2.7	148	171
	2.1	1.2	0.17	2.8	157	181
180° Arc	1.0	0.9	0.07	1.2	173	200
	1.5	1.0	0.09	1.5	180	208
	2.0	1.2	0.10	1.7	139	161
	2.1	1.2	0.10	1.7	139	161
90° Arc	1.0	0.9	0.05	0.8	247	285
	1.5	1.0	0.06	0.9	240	277
	2.0	1.2	0.06	1.1	167	193
	2.1	1.2	0.07	1.1	194	224

Performance data taken in zero wind conditions
Note: Specify spray body and nozzles separately.
Note: Radius reduction over 25% of the normal throw of the nozzle is not recommended

6 Series VAN					
0° Trajectory					
Nozzle	Pressure psi	Radius ft.	Flow gpm	■ Precip In/h	▲ Precip In/h
330° Arc 	15	4	0.85	5.58	6.44
	20	5	0.96	4.03	4.65
	25	5	1.09	4.58	5.29
	30	6	1.20	3.50	4.04
270° Arc 	15	4	0.79	6.34	7.32
	20	5	0.88	4.52	5.22
	25	5	1.00	5.13	5.92
	30	6	1.10	3.92	4.53
180° Arc 	15	4	0.42	5.05	5.83
	20	5	0.49	3.77	4.35
	25	5	0.55	4.24	4.90
	30	6	0.60	3.21	3.71
90° Arc 	15	4	0.26	6.26	7.23
	20	5	0.30	4.62	5.33
	25	5	0.34	5.24	6.05
	30	6	0.37	3.96	4.57

6 Series VAN						METRIC
0° Trajectory						
Nozzle	Pressure bar	Radius m	Flow m³/h	Flow l/m	■ Precip mm/h	▲ Precip mm/h
330° Arc 	1.0	1.2	0.19	3.2	144	166
	1.5	1.5	0.23	3.8	112	129
	2.0	1.8	0.27	4.5	91	105
	2.1	1.8	0.27	4.5	91	105
270° Arc 	1.0	1.2	0.18	3.0	167	193
	1.5	1.5	0.21	3.5	124	143
	2.0	1.8	0.24	4.1	99	114
	2.1	1.8	0.25	4.2	103	119
180° Arc 	1.0	1.2	0.10	1.6	139	161
	1.5	1.5	0.11	1.9	98	113
	2.0	1.8	0.13	2.2	80	92
	2.1	1.8	0.14	2.3	86	99
90° Arc 	1.0	1.2	0.06	1.0	167	193
	1.5	1.5	0.07	1.2	124	143
	2.0	1.8	0.08	1.4	99	114
	2.1	1.8	0.08	1.4	99	114





8 Series VAN					
5° Trajectory					
Nozzle	Pressure psi	Radius ft.	Flow gpm	■ Precip In/h	▲ Precip In/h
330° Arc 	15	6	1.21	3.53	4.07
	20	7	1.36	2.91	3.36
	25	7	1.55	3.32	3.83
	30	8	1.70	2.79	3.22
270° Arc 	15	6	1.11	3.95	4.55
	20	7	1.24	3.24	3.74
	25	7	1.41	3.69	4.25
	30	8	1.55	3.10	3.58
180° Arc 	15	6	0.84	4.49	5.18
	20	7	0.97	3.81	4.40
	25	7	1.09	4.28	4.94
	30	8	1.19	3.58	4.13
90° Arc 	15	6	0.51	5.46	6.29
	20	7	0.59	4.64	5.35
	25	7	0.66	5.19	5.98
	30	8	0.72	4.33	5.00





8 Series VAN						METRIC
5° Trajectory						
Nozzle	Pressure bar	Radius m	Flow m³/h	Flow l/m	■ Precip mm/h	▲ Precip mm/h
330° Arc 	1.0	1.8	0.27	4.6	91	105
	1.5	2.1	0.32	5.4	79	91
	2.0	2.3	0.38	6.3	78	90
	2.1	2.4	0.39	6.4	74	86
270° Arc 	1.0	1.8	0.25	4.2	103	119
	1.5	2.1	0.30	4.9	91	105
	2.0	2.3	0.34	5.8	86	99
	2.1	2.4	0.35	5.9	81	94
180° Arc 	1.0	1.8	0.19	3.2	117	135
	1.5	2.1	0.23	3.8	104	120
	2.0	2.3	0.26	4.4	98	113
	2.1	2.4	0.27	4.5	94	109
90° Arc 	1.0	1.8	0.12	1.9	148	171
	1.5	2.1	0.14	2.3	127	147
	2.0	2.3	0.16	2.7	121	140
	2.1	2.4	0.16	2.7	111	128





Note: All VAN nozzles tested on 4" (10.2 cm) pop-ups
 ■ Square spacing based on 50% diameter of throw
 ▲ Triangular spacing based on 50% diameter of throw





Performance data taken in zero wind conditions
 Note: Specify spray body and nozzles separately.
 Note: Radius reduction over 25% of the normal throw of the nozzle is not recommended

Spray Nozzles

10 Series VAN					
10° Trajectory					
Nozzle	Pressure psi	Radius ft.	Flow gpm	■ Precip In/h	▲ Precip In/h
	15	7	1.93	3.80	4.39
	20	8	2.32	3.50	4.04
	25	9	2.52	3.00	3.46
	30	10	2.60	2.50	2.89
	15	7	1.45	3.80	4.39
	20	8	1.75	3.50	4.04
	25	9	1.89	3.00	3.46
	30	10	2.10	2.70	3.12
	15	7	0.97	3.80	4.39
	20	8	1.20	3.50	4.04
	25	9	1.26	3.00	3.46
	30	10	1.45	2.80	3.23
	15	7	0.48	3.80	4.39
	20	8	0.58	3.50	4.04
	25	9	0.63	3.00	3.46
	30	10	0.75	2.90	3.35





10 Series VAN					METRIC	
10° Trajectory						
Nozzle	Pressure bar	Radius m	Flow m³/h	Flow l/m	■ Precip mm/h	▲ Precip mm/h
	1.0	2.1	0.44	7.3	96	111
	1.5	2.4	0.53	9.0	89	103
	2.0	2.7	0.57	9.8	76	88
	2.1	3.1	0.59	9.8	63	73
	2.1	3.1	0.59	9.8	63	73
	1.0	2.1	0.33	5.5	96	111
	1.5	2.4	0.4	6.8	89	103
	2.0	2.7	0.43	7.8	76	88
	2.1	3.1	0.48	7.9	68	79
	2.1	3.1	0.48	7.9	68	79
	1.0	2.1	0.22	3.7	96	111
	1.5	2.4	0.27	4.6	89	103
	2.0	2.7	0.29	5.3	76	88
	2.1	3.1	0.33	5.5	71	82
	2.1	3.1	0.33	5.5	71	82
	1.0	2.1	0.11	1.8	96	111
	1.5	2.4	0.13	2.3	89	103
	2.0	2.7	0.14	2.7	76	88
	2.1	3.1	0.17	2.8	73	85
	2.1	3.1	0.17	2.8	73	85





12 Series VAN					
15° Trajectory					
Nozzle	Pressure psi	Radius ft.	Flow gpm	■ Precip In/h	▲ Precip In/h
	15	9	1.56	1.86	2.14
	20	10	1.86	1.79	2.06
	25	11	2.12	1.68	1.95
	30	12	2.36	1.58	1.82
	15	9	1.17	1.86	2.14
	20	10	1.39	1.79	2.06
	25	11	1.59	1.68	1.94
	30	12	1.77	1.58	1.82
	15	9	0.78	1.86	2.14
	20	10	0.93	1.79	2.06
	25	11	1.06	1.68	1.95
	30	12	1.18	1.58	1.82
	15	9	0.39	1.86	2.14
	20	10	0.46	1.79	2.06
	25	11	0.53	1.68	1.95
	30	12	0.59	1.58	1.82





12 Series VAN					METRIC	
15° Trajectory						
Nozzle	Pressure bar	Radius m	Flow m³/h	Flow l/m	■ Precip mm/h	▲ Precip mm/h
	1.0	2.7	0.35	5.80	48	55
	1.5	3.2	0.44	7.37	43	50
	2.0	3.6	0.52	8.75	41	47
	2.1	3.7	0.54	9.02	40	46
	2.1	3.7	0.54	9.02	40	46
	1.0	2.7	0.26	4.35	48	55
	1.5	3.2	0.33	5.53	43	50
	2.0	3.6	0.39	6.56	41	47
	2.1	3.7	0.41	6.76	40	46
	2.1	3.7	0.41	6.76	40	46
	1.0	2.7	0.17	2.90	48	55
	1.5	3.2	0.22	3.69	43	50
	2.0	3.6	0.26	4.37	41	47
	2.1	3.7	0.27	4.51	40	46
	2.1	3.7	0.27	4.51	40	46
	1.0	2.7	0.09	1.45	48	55
	1.5	3.2	0.11	1.84	43	50
	2.0	3.6	0.13	2.19	41	47
	2.1	3.7	0.14	2.25	40	46
	2.1	3.7	0.14	2.25	40	46





Note: All VAN nozzles tested on 4" (10.2 cm) pop-ups
 ■ Square spacing based on 50% diameter of throw
 ▲ Triangular spacing based on 50% diameter of throw

Performance data taken in zero wind conditions
Note: Specify spray body and nozzles separately.
Note: Radius reduction over 25% of the normal throw of the nozzle is not recommended

15 Series VAN					
23° Trajectory					
Nozzle	Pressure psi	Radius ft.	Flow gpm	■ Precip In/h	▲ Precip In/h
 360° Arc	15	11	2.60	2.07	2.39
	20	12	3.00	2.01	2.32
	25	14	3.30	1.62	1.87
	30	15	3.70	1.58	1.83
 270° Arc	15	11	1.95	2.07	2.39
	20	12	2.25	2.01	2.32
	25	14	2.48	1.62	1.87
	30	15	2.78	1.58	1.83
 180° Arc	15	11	1.30	2.07	2.39
	20	12	1.50	2.01	2.32
	25	14	1.65	1.62	1.87
	30	15	1.85	1.58	1.83
 90° Arc	15	11	0.65	2.07	2.39
	20	12	0.75	2.01	2.32
	25	14	0.82	1.62	1.87
	30	15	0.92	1.58	1.83

15 Series VAN						METRIC
23° Trajectory						
Nozzle	Pressure bar	Radius m	Flow m ³ /h	Flow l/m	■ Precip mm/h	▲ Precip mm/h
 360° Arc	1.0	3.4	0.60	9.8	52	60
	1.5	3.9	0.72	11.8	47	55
	2.0	4.5	0.84	13.7	41	48
	2.1	4.6	0.84	14.0	40	46
 270° Arc	1.0	3.4	0.45	7.4	52	60
	1.5	3.9	0.54	8.8	47	55
	2.0	4.5	0.63	10.3	41	48
	2.1	4.6	0.63	10.5	40	46
 180° Arc	1.0	3.4	0.30	4.9	52	60
	1.5	3.9	0.36	5.9	47	55
	2.0	4.5	0.42	6.9	41	48
	2.1	4.6	0.42	7.0	40	46
 90° Arc	1.0	3.4	0.15	2.5	52	60
	1.5	3.9	0.18	2.9	47	55
	2.0	4.5	0.21	3.4	41	48
	2.1	4.6	0.21	3.5	40	46

18 Series VAN					
26° Trajectory					
Nozzle	Pressure psi	Radius ft.	Flow gpm	■ Precip In/h	▲ Precip In/h
 360° Arc	15	14	4.21	2.07	2.39
	20	15	4.70	2.01	2.32
	25	17	4.86	1.62	1.87
	30	18	5.32	1.58	1.83
 270° Arc	15	14	3.16	2.07	2.39
	20	15	3.52	2.01	2.32
	25	17	3.65	1.62	1.87
	30	18	3.99	1.58	1.83
 180° Arc	15	14	2.11	2.07	2.39
	20	15	2.35	2.01	2.32
	25	17	2.43	1.62	1.87
	30	18	2.66	1.58	1.83
 90° Arc	15	14	1.05	2.07	2.39
	20	15	1.17	2.01	2.32
	25	17	1.22	1.62	1.87
	30	18	1.33	1.58	1.83

18 Series VAN						METRIC
26° Trajectory						
Nozzle	Pressure bar	Radius m	Flow m ³ /h	Flow l/m	■ Precip mm/h	▲ Precip mm/h
 360° Arc	1.0	4.3	0.96	15.9	52	60
	1.5	4.8	1.07	18.0	47	55
	2.0	5.4	1.20	19.8	41	48
	2.1	5.5	1.21	20.1	40	46
 270° Arc	1.0	4.3	0.72	12.0	52	60
	1.5	4.8	0.80	13.5	47	55
	2.0	5.4	0.90	14.8	41	48
	2.1	5.5	0.91	15.1	40	46
 180° Arc	1.0	4.3	0.48	8.0	52	60
	1.5	4.8	0.54	9.0	47	55
	2.0	5.4	0.60	9.9	41	48
	2.1	5.5	0.61	10.1	40	46
 90° Arc	1.0	4.3	0.24	4.0	52	60
	1.5	4.8	0.27	4.5	47	55
	2.0	5.4	0.30	5.0	41	48
	2.1	5.5	0.30	5.0	40	46

Note: All VAN nozzles tested on 4" (10.2 cm) pop-ups
 ■ Square spacing based on 50% diameter of throw
 ▲ Triangular spacing based on 50% diameter of throw

Performance data taken in zero wind conditions
Note: Specify spray body and nozzles separately.
Note: Radius reduction over 25% of the normal throw of the nozzle is not recommended

Spray Nozzles

HE-VAN Series Nozzles

High-Efficiency Variable Arc Spray Nozzles



Features

- Greater than a 70% average DULQ—more than a 40 percent improvement over existing variable arc nozzles¹
- Low-trajectory spray and large water droplets resist prevailing winds and maximize water landing in the target zone
- Reduced zone run times, compared to competitive nozzles, help stay within tight watering windows, conserve water, and save money
- With full adjustability from 0° to 360°, you'll be able to efficiently water landscapes of all shapes, while saving time and stocking fewer nozzles
- Matched precipitation rates allow you to install Rain Bird® HE-VAN, MPR and U-Series Nozzles on the same zone
- Three year trade warranty

Operating Range

- Spacing: 6 to 8 feet (1.8 to 4.6 m)²
- Pressure: 15 to 30 psi (1.0 to 2.1 bar)
- Optimum pressure: 30 psi (2.1 bar)³

Models

- HE-VAN-08: 6 to 8 feet (1.8 to 2.4 m)
- HE-VAN-10: 8 to 10 feet (2.4 to 3.0 m)
- HE-VAN-12: 9 to 12 feet (2.7 to 3.7 m)
- HE-VAN-15: 12 to 15 feet (3.7 to 4.6 m)

¹ Distribution Uniformity (DU_{10}): DU in irrigation is a measure of how uniformly water is applied to the area being watered. DU_{10} is calculated by taking the volume in the lowest quarter of catch can measurements and dividing it by the average volume of all catch can measurements.

² These ranges are based on proper pressure at nozzle

³ Rain Bird recommends using 1800 PRS Spray Bodies to maintain optimum nozzle performance in higher pressure situations



Stainless steel adjustment screw to adjust flow and radius, up to a 25% reduction in radius

Available in popular 8', 10', 12' and 15' models

Fits on all Rain Bird® 1800® Series Spray Heads, UNI-Spray™ Series Spray Heads and Rain Bird Shrub Adapters







How To Specify





HE-VAN-15





Radius Range
15: 15 feet (4.6 m)





Feature
VAN: Variable Arc

Model
High Efficiency Nozzle

8 Series HE-VAN					
24° Trajectory					
Nozzle	Pressure psi	Radius ft.	Flow gpm	■ Precip In/h	▲ Precip In/h
	15	5	0.83	3.19	3.68
	20	6	0.96	2.56	2.95
	25	7	1.07	2.10	2.42
	30	8	1.17	1.76	2.03
	15	5	0.62	3.19	3.68
	20	6	0.72	2.56	2.95
	25	7	0.80	2.10	2.42
	30	8	0.88	1.76	2.03
	15	5	0.41	3.19	3.68
	20	6	0.48	2.56	2.95
	25	7	0.53	2.10	2.42
	30	8	0.59	1.76	2.03
	15	5	0.21	3.19	3.68
	20	6	0.24	2.56	2.95
	25	7	0.27	2.10	2.42
	30	8	0.29	1.76	2.03





8 Series HE-VAN						METRIC
24° Trajectory						
Nozzle	Pressure bar	Radius m	Flow m³/h	Flow l/m	■ Precip mm/h	▲ Precip mm/h
	1.03	1.52	0.19	3.14	82	95
	1.38	1.83	0.22	3.62	66	76
	1.72	2.13	0.25	4.05	54	62
	2.07	2.44	0.27	4.43	45	52
	1.03	1.52	0.14	2.35	82	95
	1.38	1.83	0.16	2.72	66	76
	1.72	2.13	0.18	3.04	54	62
	2.07	2.44	0.20	3.33	45	52
	1.03	1.52	0.10	1.57	82	95
	1.38	1.83	0.11	1.81	66	76
	1.72	2.13	0.12	2.02	54	62
	2.07	2.44	0.13	2.22	45	52
	1.03	1.52	0.05	0.78	82	95
	1.38	1.83	0.05	0.91	66	76
	1.72	2.13	0.06	1.01	54	62
	2.07	2.44	0.07	1.11	45	52





10 Series HE-VAN					
27° Trajectory					
Nozzle	Pressure psi	Radius ft.	Flow gpm	■ Precip In/h	▲ Precip In/h
	15	7	1.26	2.48	2.86
	20	8	1.46	2.19	2.53
	25	9	1.63	1.94	2.24
	30	10	1.78	1.72	1.98
	15	7	0.95	2.48	2.86
	20	8	1.09	2.19	2.53
	25	9	1.22	1.94	2.24
	30	10	1.34	1.72	1.98
	15	7	0.63	2.48	2.86
	20	8	0.73	2.19	2.53
	25	9	0.81	1.94	2.24
	30	10	0.89	1.72	1.98
	15	7	0.32	2.48	2.86
	20	8	0.36	2.19	2.53
	25	9	0.41	1.94	2.24
	30	10	0.45	1.72	1.98





10 Series HE-VAN						METRIC
27° Trajectory						
Nozzle	Pressure bar	Radius m	Flow m³/h	Flow l/m	■ Precip mm/h	▲ Precip mm/h
	1.03	2.13	0.29	4.78	64	74
	1.38	2.44	0.34	5.52	56	65
	1.72	2.74	0.37	6.17	50	57
	2.07	3.05	0.41	6.76	44	51
	1.03	2.13	0.22	3.59	64	74
	1.38	2.44	0.25	4.14	56	65
	1.72	2.74	0.28	4.63	50	57
	2.07	3.05	0.31	5.07	44	51
	1.03	2.13	0.15	2.39	64	74
	1.38	2.44	0.17	2.76	56	65
	1.72	2.74	0.19	3.09	50	57
	2.07	3.05	0.21	3.38	44	51
	1.03	2.13	0.07	1.20	64	74
	1.38	2.44	0.08	1.38	56	65
	1.72	2.74	0.09	1.54	50	57
	2.07	3.05	0.10	1.69	44	51





Note: All HE-VAN nozzles tested on 4" (10.2 cm) pop-ups
 ■ Square spacing based on 50% diameter of throw
 ▲ Triangular spacing based on 50% diameter of throw

Performance data taken in zero wind conditions
 Note: Specify spray body and nozzles separately.
 Note: Radius reduction over 25% of the normal throw of the nozzle is not recommended

12 Series HE-VAN					
23° Trajectory					
Nozzle	Pressure psi	Radius ft.	Flow gpm	■ Precip In/h	▲ Precip In/h
 360° Arc	15	9	1.67	1.99	2.30
	20	10	1.93	1.86	2.15
	25	11	2.16	1.72	1.99
	30	12	2.37	1.58	1.83
 270° Arc	15	9	1.25	1.99	2.30
	20	10	1.45	1.86	2.15
	25	11	1.62	1.72	1.99
	30	12	1.77	1.58	1.83
 180° Arc	15	9	0.84	1.99	2.30
	20	10	0.97	1.86	2.15
	25	11	1.08	1.72	1.99
	30	12	1.18	1.58	1.83
 90° Arc	15	9	0.42	1.99	2.30
	20	10	0.48	1.86	2.15
	25	11	0.54	1.72	1.99
	30	12	0.59	1.58	1.83

12 Series HE-VAN						METRIC	
23° Trajectory							
Nozzle	Pressure bar	Radius m	Flow m ³ /h	Flow l/m	■ Precip mm/h	▲ Precip mm/h	
 360° Arc	1.0	2.7	0.38	6.33	50.5	58.3	
	1.4	3.0	0.44	7.31	47.3	54.6	
	1.7	3.4	0.49	8.18	43.7	50.4	
	2.1	3.7	0.54	8.96	40.2	46.4	
 270° Arc	1.0	2.7	0.28	4.75	50.5	58.3	
	1.4	3.0	0.33	5.48	47.3	54.6	
	1.7	3.4	0.37	6.16	43.7	50.4	
	2.1	3.7	0.40	6.72	40.2	46.4	
 180° Arc	1.0	2.7	0.19	3.17	50.5	58.3	
	1.4	3.0	0.22	3.66	47.3	54.6	
	1.7	3.4	0.25	4.09	43.7	50.4	
	2.1	3.7	0.27	4.48	40.2	46.4	
 90° Arc	1.0	2.7	0.09	1.58	50.5	58.3	
	1.4	3.0	0.11	1.83	47.3	54.6	
	1.7	3.4	0.12	2.04	43.7	50.4	
	2.1	3.7	0.13	2.24	40.2	46.4	

15 Series HE-VAN					
25° Trajectory					
Nozzle	Pressure psi	Radius ft.	Flow gpm	■ Precip In/h	▲ Precip In/h
 360° Arc	15	11	2.62	2.08	2.40
	20	12	3.02	2.02	2.33
	25	14	3.38	1.66	1.92
	30	15	3.70	1.58	1.83
 270° Arc	15	11	1.96	2.08	2.40
	20	12	2.27	2.02	2.33
	25	14	2.53	1.66	1.92
	30	15	2.78	1.58	1.83
 180° Arc	15	11	1.31	2.08	2.40
	20	12	1.51	2.02	2.33
	25	14	1.69	1.66	1.92
	30	15	1.85	1.58	1.83
 90° Arc	15	11	0.65	2.08	2.40
	20	12	0.76	2.02	2.33
	25	14	0.84	1.66	1.92
	30	15	0.93	1.58	1.83

15 Series HE-VAN						METRIC	
25° Trajectory							
Nozzle	Pressure bar	Radius m	Flow m ³ /h	Flow l/m	■ Precip mm/h	▲ Precip mm/h	
 360° Arc	1.0	3.4	0.59	9.91	52.9	61.1	
	1.4	3.7	0.69	11.44	51.3	59.3	
	1.7	4.3	0.77	12.79	42.2	48.7	
	2.1	4.6	0.84	14.01	40.2	46.5	
 270° Arc	1.0	3.4	0.45	7.43	52.9	61.1	
	1.4	3.7	0.51	8.58	51.3	59.3	
	1.7	4.3	0.58	9.59	42.2	48.7	
	2.1	4.6	0.63	10.51	40.2	46.5	
 180° Arc	1.0	3.4	0.30	4.95	52.9	61.1	
	1.4	3.7	0.34	5.72	51.3	59.3	
	1.7	4.3	0.38	6.39	42.2	48.7	
	2.1	4.6	0.42	7.00	40.2	46.5	
 90° Arc	1.0	3.4	0.15	2.48	52.9	61.1	
	1.4	3.7	0.17	2.86	51.3	59.3	
	1.7	4.3	0.19	3.20	42.2	48.7	
	2.1	4.6	0.21	3.50	40.2	46.5	

Note: All HE-VAN nozzles tested on 4" (10.2 cm) pop-ups

■ Square spacing based on 50% diameter of throw

▲ Triangular spacing based on 50% diameter of throw

Performance data taken in zero wind conditions

Note: Specify spray body and nozzles separately.

Note: Radius reduction over 25% of the normal throw of the nozzle is not recommended

Rotary Nozzles

0.6 in/hr Precipitation Rate from 13 to 24 Feet



Features

- Greater distribution uniformity keeps your landscape green without overwatering
- Thick wind-resistant streams and large water droplets resist prevailing winds and maximize water landing in the target zone
- Low 0.6"/hr precipitation reduces or eliminates run-off on slopes and hard clay soils with 35% less run time than the leading competitor
- Matched precipitation rates enable large and small turf areas to be zoned together by mixing R-Series rotary nozzles, RVAN, and 5000 Series rotors with the MPR nozzle set
- Three-year trade warranty

Operating Range

- Spacing: 13 feet to 24 feet (4.0 m to 7.3 m)¹
- Pressure range: 20-55 psi (1.4 to 3.8 bar)
- Recommended Operating Pressure: 45 psi (3.1 bar)²

Models

- There are three different patterns available which are available in two radius ranges:
 - 13'-18' (4.0m to 5.5m)
 - 17'-24' (5.2m to 7.3m)

¹ These ranges are based on proper pressure at nozzle

² Rain Bird recommends using 1800 P45 Spray Bodies to maintain optimum nozzle performance in higher pressure situations



Color-coded radius reduction plugs for easy identification.

Rotary Nozzles

Stainless steel screw allows radius reduction to accommodate varying landscape needs.

Spray Nozzles



Full



Half



Quarter

With Conventional Spray Nozzles

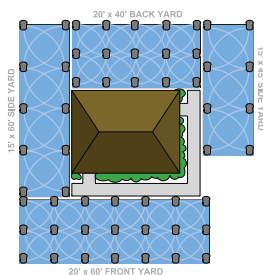

- Total 58 gpm
- 6 zones required

With Rotary Nozzles

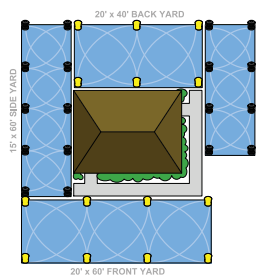

- Total 26 gpm
- 3 zones required

How To Specify



R13-18 Q



Pattern
F=Full
H=Half
Q=Quarter



Radius Range
13'-18' (4.0-5.5 m)
17'-24' (5.2-7.3 m)



Model
Rotary Nozzle

Note: Installation on Rain Bird 1800®-SAM Spray Bodies recommended in sandy environments

R13-18 Series (Black)					
Arc	Pressure psi	Radius* ft.	Flow gpm	■ Precip In/h	▲ Precip In/h
	20	13	1.31	0.75	0.86
	25	14	1.46	0.67	0.77
	30	16	1.60	0.61	0.70
	35	16	1.73	0.61	0.70
	40	17	1.85	0.61	0.70
	45	18	1.96	0.61	0.70
	50	18	2.07	0.61	0.70
	20	13	0.65	0.75	0.86
	25	14	0.73	0.67	0.77
	30	16	0.80	0.61	0.70
	35	16	0.86	0.61	0.70
	40	17	0.92	0.61	0.70
	45	18	0.98	0.61	0.70
	50	18	1.03	0.61	0.70
	20	13	0.33	0.75	0.86
	25	14	0.37	0.67	0.77
	30	16	0.40	0.61	0.70
	35	16	0.43	0.61	0.70
	40	17	0.46	0.61	0.70
	45	18	0.49	0.61	0.70
	50	18	0.52	0.61	0.70

R13-18 Series (Black)					METRIC
Arc	Pressure bar	Radius* m	Flow l/m	■ Precip mm/h	▲ Precip mm/h
	1.4	4.0	4.95	19	22
	1.7	4.3	5.53	18	21
	2.1	4.8	6.06	15	18
	2.4	5.0	6.54	15	18
	2.8	5.2	6.99	15	18
	3.1	5.4	7.42	15	18
	3.4	5.5	7.82	15	18
	1.4	4.0	2.47	19	22
	1.7	4.3	2.76	18	21
	2.1	4.8	3.03	15	18
	2.4	5.0	3.27	15	18
	2.8	5.2	3.50	15	18
	3.1	5.4	3.71	15	18
	3.4	5.5	3.91	15	18
	1.4	4.0	1.24	19	22
	1.7	4.3	1.38	18	21
	2.1	4.8	1.51	15	18
	2.4	5.0	1.64	15	18
	2.8	5.2	1.75	15	18
	3.1	5.4	1.85	15	18
	3.4	5.5	1.95	15	18

R17-24 Series (Yellow)					
Arc	Pressure psi	Radius* ft.	Flow gpm	■ Precip In/h	▲ Precip In/h
	20	17	2.45	0.79	0.92
	25	19	2.74	0.71	0.82
	30	21	3.00	0.65	0.75
	35	22	3.24	0.65	0.75
	40	23	3.46	0.65	0.75
	45	23	3.67	0.65	0.75
	50	24	3.87	0.65	0.75
	20	17	1.22	0.79	0.92
	25	19	1.37	0.71	0.82
	30	21	1.50	0.65	0.75
	35	22	1.62	0.65	0.75
	40	23	1.73	0.65	0.75
	45	23	1.84	0.65	0.75
	50	24	1.94	0.65	0.75
	20	17	0.61	0.79	0.92
	25	19	0.68	0.71	0.82
	30	21	0.75	0.65	0.75
	35	22	0.81	0.65	0.75
	40	23	0.87	0.65	0.75
	45	23	0.92	0.65	0.75
	50	24	0.97	0.65	0.75

R17-24 Series (Yellow)					METRIC
Arc	Pressure bar	Radius* m	Flow l/m	■ Precip mm/h	▲ Precip mm/h
	1.4	5.2	9.27	20	23
	1.7	5.8	10.37	18	21
	2.1	6.4	11.36	16	19
	2.4	6.7	12.26	16	19
	2.8	6.9	13.10	16	19
	3.1	7.1	13.89	16	19
	3.4	7.3	14.65	16	19
	1.4	5.2	4.62	20	23
	1.7	5.8	5.19	18	21
	2.1	6.4	5.68	16	19
	2.4	6.7	6.17	16	19
	2.8	6.9	6.55	16	19
	3.1	7.1	6.97	16	19
	3.4	7.3	7.34	16	19
	1.4	5.2	2.31	20	23
	1.7	5.8	2.57	18	21
	2.1	6.4	2.84	16	19
	2.4	6.7	3.07	16	19
	2.8	6.9	3.29	16	19
	3.1	7.1	3.48	16	19
	3.4	7.3	3.67	16	19

Note: All Rotary nozzles tested on 4" (10.2 cm) pop-ups
 ■ Square spacing based on 50% diameter of throw
 ▲ Triangular spacing based on 50% diameter of throw

Performance data taken in zero wind conditions
Note: Specify spray body and nozzles separately.
Note: Radius reduction over 25% of the normal throw of the nozzle is not recommended

R-VAN Series Nozzles

The World's First Hand-Adjustable Rotary Nozzles

Features

- 100% hand adjustable for quick and easy installation with no searching for proprietary tools
- Greater distribution uniformity keeps your landscape green without overwatering
- Thick wind-resistant streams and large water droplets resist prevailing winds and maximize water landing in the target zone
- Low 0.6"/hr precipitation reduces or eliminates run-off on slopes and hard clay soils with 35% less run time than the leading competitor
- Matched precipitation rates enable large and small turf areas to be zoned together by mixing RVAN, 5000 Series rotors with the MPR nozzle set, and R-Series rotary nozzles
- Three year trade warranty

Operating Range

- Spacing: 13' to 24' (4.0 to 7.3m)¹
- Pressure Range: 20 to 55 psi (1.4 to 3.8 bar)
- Recommended Operating Pressure: 45 psi (3.1 bar)²

Models

- **R-VAN1318**
 - Black Rotary Deflector
 - 13' to 18' (4.0 to 5.5m) radius
 - 45° to 270° arc
- **R-VAN1724**
 - Yellow Rotary Deflector
 - 17' to 24' (5.2 to 7.3m) radius
 - 45° to 270° arc

¹ These ranges are based on proper pressure at nozzle

² Rain Bird recommends using 1800 PRS Spray Bodies to maintain optimum nozzle performance in higher pressure situations

Notes:

- Adjustments: Arc and radius should be adjusted while water is running.
- Operation of radius below minimum radius (per model) is not recommended.
- Installation on Rain Bird 1800SAM-P45 spray bodies recommended in sandy environments.

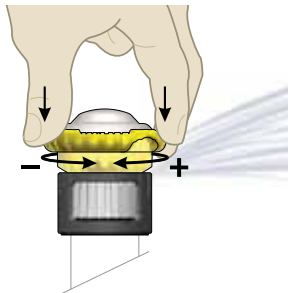

Arc Adjustment

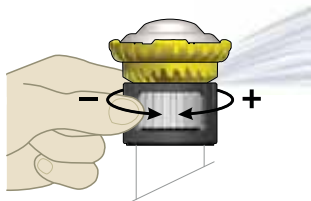

Radius Adjustment



R-VAN Series Nozzle

How To Specify

R-VAN- 1318



Radius Range



1318: 13' to 18' (4.0 to 5.5m)



1724: 17' to 24' (5.2 to 7.3m)



Model

R-VAN Adjustable Rotary Nozzle

R-VAN 1318 (Black)					
Nozzle	Pressure psi	Radius ft.	Flow gpm	■ Precip In/h	▲ Precip In/h
	20	13	0.95	0.72	0.83
	25	14	1.12	0.69	0.80
	30	16	1.26	0.65	0.75
	35	16	1.35	0.64	0.74
	40	17	1.42	0.63	0.73
	45	17	1.51	0.64	0.73
	50	18	1.57	0.60	0.69
55	18	1.62	0.60	0.69	
	20	13	0.75	0.72	0.83
	25	14	0.83	0.69	0.80
	30	16	0.85	0.65	0.75
	35	16	0.91	0.64	0.74
	40	17	0.98	0.63	0.73
	45	17	1.01	0.64	0.73
	50	18	1.07	0.60	0.69
55	18	1.09	0.60	0.69	
	20	13	0.37	0.72	0.83
	25	14	0.39	0.69	0.80
	30	16	0.42	0.65	0.75
	35	16	0.47	0.64	0.74
	40	17	0.50	0.63	0.73
	45	17	0.50	0.64	0.73
	50	18	0.54	0.60	0.69
55	18	0.58	0.60	0.69	

R-VAN 1318 (Black)					METRIC	
Nozzle	Pressure bar	Radius m	Flow l/m	■ Precip mm/h	▲ Precip mm/h	
	1.4	4.0	3.60	18	21	
	1.7	4.3	4.24	18	20	
	2.1	4.9	4.77	17	19	
	2.4	4.9	5.11	16	19	
	2.8	5.2	5.38	16	18	
	3.1	5.2	5.72	16	18	
	3.4	5.5	5.94	15	18	
	3.8	5.5	6.13	15	18	
		1.4	4.0	2.84	18	21
		1.7	4.3	3.14	18	20
2.1		4.9	3.22	17	19	
2.4		4.9	3.44	16	19	
2.8		5.2	3.71	16	18	
3.1		5.2	3.82	16	18	
3.4		5.5	4.05	15	18	
3.8		5.5	4.13	15	18	
		1.4	4.0	1.40	18	21
		1.7	4.3	1.48	18	20
	2.1	4.9	1.59	17	19	
	2.4	4.9	1.78	16	19	
	2.8	5.2	1.89	16	18	
	3.1	5.2	1.89	16	18	
	3.4	5.5	2.04	15	18	
	3.8	5.5	2.20	15	18	

R-VAN 1724 (Yellow)					
Nozzle	Pressure psi	Radius ft.	Flow gpm	■ Precip In/h	▲ Precip In/h
	20	17	1.77	0.76	0.88
	25	19	1.99	0.72	0.83
	30	21	2.26	0.70	0.81
	35	22	2.39	0.66	0.76
	40	23	2.55	0.63	0.73
	45	23	2.73	0.64	0.73
	50	24	2.76	0.61	0.70
55	24	2.80	0.61	0.70	
	20	17	1.24	0.76	0.88
	25	19	1.30	0.72	0.83
	30	21	1.41	0.70	0.81
	35	22	1.55	0.66	0.76
	40	23	1.69	0.63	0.73
	45	23	1.83	0.64	0.73
	50	24	1.91	0.61	0.70
55	24	1.98	0.61	0.70	
	20	17	0.59	0.76	0.88
	25	19	0.67	0.72	0.83
	30	21	0.73	0.70	0.81
	35	22	0.78	0.66	0.76
	40	23	0.85	0.63	0.73
	45	23	0.91	0.64	0.73
	50	24	0.98	0.61	0.70
55	24	1.05	0.61	0.70	

R-VAN 1724 (Yellow)					METRIC	
Nozzle	Pressure bar	Radius m	Flow l/m	■ Precip mm/h	▲ Precip mm/h	
	1.4	5.2	6.70	19	22	
	1.7	5.8	7.53	18	21	
	2.1	6.4	8.56	18	21	
	2.4	6.7	9.05	17	19	
	2.8	7.0	9.65	16	18	
	3.1	7.0	10.33	16	18	
	3.4	7.3	10.45	15	18	
	3.8	7.3	10.60	15	18	
		1.4	5.2	4.69	19	22
		1.7	5.8	4.92	18	21
2.1		6.4	5.34	18	21	
2.4		6.7	5.87	17	19	
2.8		7.0	6.40	16	18	
3.1		7.0	6.93	16	18	
3.4		7.3	7.23	15	18	
3.8		7.3	7.50	15	18	
		1.4	5.2	2.23	19	22
		1.7	5.8	2.54	18	21
	2.1	6.4	2.76	18	21	
	2.4	6.7	2.95	17	19	
	2.8	7.0	3.22	16	18	
	3.1	7.0	3.44	16	18	
	3.4	7.3	3.71	15	18	
	3.8	7.3	3.97	15	18	

Note: All R-VAN nozzles tested on 4" (10.2 cm) pop-ups

■ Square spacing based on 50% diameter of throw

▲ Triangular spacing based on 50% diameter of throw

Performance data taken in zero wind conditions

Note: Specify spray body and nozzles separately.

Note: Radius reduction over 25% of the normal throw of the nozzle is not recommended

1300A-F

Adjustable Full-Circle Bubbler

Features

- Stainless Steel adjustment screw regulates flow and radius for spacing between from 1 to 3 feet (0.3 m to 0.9 m) apart
- Non-corrosive plastic and stainless steel construction for long life
- Shipped with SR-050 1/2" (15/21) inlet filter screen for easy installation and resistance to debris
- Operates over a wide range of pressures
- Five year trade warranty

Operating Range

- Flow: 1.0 to 2.3 gpm (3.6 to 8.4 l/m)
- Spacing: 1 to 3 feet (0.3 to 0.9 m)¹
- Pressure: 10 to 60 psi (0.7 to 4.1 bar)²

Model

- 1300A-F

¹ These ranges are based on proper pressure at nozzle

² Rain Bird recommends using 1800 PRS Spray Bodies to maintain optimum nozzle performance in higher pressure situations

1300A-F		
Nozzle	Pressure psi	Flow gpm
F	10	1.0
	20	1.4
	30	1.7
	40	1.9
	50	2.1
	60	2.3

1300A-F		METRIC	
Nozzle	Pressure bar	Flow m ³ /h	Flow l/m
F	0.7	0.23	3.6
	1.0	0.26	4.2
	1.5	0.30	4.8
	2.0	0.34	5.4
	2.5	0.39	6.0
	3.0	0.43	7.2
	3.5	0.48	7.8
	4.0	0.52	8.4
	4.1	0.53	8.4



1300A-F

1400 Series

Pressure Compensating Full-Circle Bubblers

Features

- Low flow rates allow water to be absorbed as needed. Reduces runoff
- Flow will not fluctuate at pressures between 20 and 90 psi (1.4 to 6.2 bar)
- Flow is not adjustable for increased vandal resistance
- Shipped with special SR-050 1/2" (15/21) bubbler filter screen for easy installation and resistance to debris
- Trickle pattern on models 1401 and 1402; umbrella pattern on models 1404 and 1408
- Five-year trade warranty

Operating Range

- Flow: 0.25 to 2.00 gpm (1.2 to 7.2 l/m)
- Spacing: 1 to 3 feet (0.3 to 0.9 m)*
- Pressure: 20 to 90 psi (1.4 to 6.2 bar)

Models

- 1401: 0.25 gpm (0.06 m³/h; 0.9 l/m); full-circle, trickle pattern
- 1402: 0.50 gpm (0.11 m³/h; 1.8 l/m); full-circle, trickle pattern
- 1404: 1.00 gpm (0.23 m³/h; 3.6 l/m); full-circle, umbrella pattern
- 1408: 2.00 gpm (0.46 m³/h; 7.2 l/m); full-circle, umbrella pattern

* These ranges are based on proper pressure at nozzle. Rain Bird recommends using 1800 PRS Spray Bodies to maintain optimum nozzle performance in higher pressure situations.



1400 Series

Rotors

Introduction

Spray Bodies

Spray Nozzles

Rotors

Valves

Controllers

Central Controls

Landscape Drip

Pumps

Drainage Products

Resources



"Once my customers actually see the difference Rain Curtain nozzles make, they won't settle for anything but Rain Bird Rotors. They've really helped me build my business."

Dennis Hoffman
Grasshopper Irrigation, Inc.

Major Products	Closed Case Rotors				Open Case Rotor
	3504 Series	5000 Series	8005 Series	Falcon™ 6504 Series	2045A Maxi-Paw™ Series
Primary Applications					
Turfgrass 15' to 30'	●	●			
Turfgrass 25' to 50'		●	●	●	●
Turfgrass more than 50'			●	●	
Residential	●	●			●
Commercial		●	●	●	●
Vandalism/Damage Prone Areas			●		
Slopes	●	●	●	●	●
Ground Cover/Shrubs	●	●			
Athletic Fields			●	●	
Pressure Regulating		●			
High Wind Areas	●	●	●	●	●
Taller Turfgrass		●	●		
Non-Potable Water	●	●	●	●	●



Water Saving Tips

- Rain Curtain™ nozzle technology is the standard in water-saving nozzle performance. Rain Curtain™ performance is available in all Rain Bird Rotors.
- 5000 Series Rotors with PRS reduce water waste from 15%-45%. By eliminating pressure variation and/or over pressurization, you'll save water and deliver greener results.
- All rotors with Seal-a-Matic™ (SAM) check valves prevent drainage from heads at lower elevations, stop water waste and eliminate landscape damage due to flooding and/or erosion.

3500 Series

Compact Residential Rotor. Big on Value and Convenience

Features

- Rain Curtain™ nozzles deliver even distribution over the entire radius including large wind resistant droplets and gentle close-in watering resulting in greener turf using less water
- Oversized wiper seal prevents leaks and protects internals from debris
- Arc adjustment through the top of the rotor requiring only a flat-blade screwdriver
- 3 year trade warranty

Operating Specifications

- Precipitation rate: 0.37 to 0.83 inches per hour (9 to 21 mm/h)
- Radius: 15 to 35 feet (4.6 to 10.7 m)
- Radius may be reduced up to 25% with radius reduction screw
- Pressure: 25 to 55 psi (1.7 to 3.8 bar)
- Flow rate: 0.54 to 4.6 gpm (2.0 to 17.4 l/m)
- ½" NPT female bottom threaded inlet
- Reversing full- and part-circle adjustment 40° - 360°

Models

Part-circle units (PC) are adjustable from 40 -360 degrees.

- 3504-PC: 4" part/reverse full circle
- 3504-PC-SAM: 4" part/reverse full circle with SAM™
- 3504-PC-SAM-NP: 4" part/reverse full circle with SAM and NP cover
- 3500-S-SAM: 4" part/reverse full circle shrub model with SAM



3504-PC

 0.37 to 0.83 in/hr
(9 to 21 mm/h)

 25 to 55 psi
(1.7 to 3.8 bar)

 0.54 to 4.6 gpm
(2.0 to 17.4 l/m)
(0.12 to 1.04 m³/h)

 4" (10.2 cm)
Shrub: 7" (17.8 cm)
4": 6 5/8" (16.8 cm)
½" (20/27) NPT

How To Specify

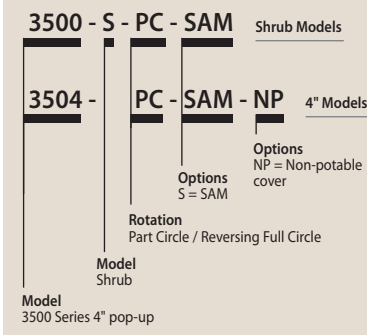

Superior Distribution Uniformity

The 3500 Series Rotors with Rain Curtain Technology are engineered to deliver a uniform spray pattern, giving you a consistently green lawn throughout.

3504 Series Nozzle Performance					
Pressure psi	Nozzle	Radius ft.	Flow gpm	■ Precip In/h	▲ Precip In/h
25	0.75	15	0.54	0.46	0.53
	1.0	20	0.77	0.37	0.43
	1.5	23	1.06	0.39	0.45
	2.0	27	1.40	0.37	0.43
	3.0	29	2.17	0.50	0.57
	4.0	31	2.97	0.59	0.69
35	0.75	17	0.67	0.45	0.52
	1.0	21	0.92	0.40	0.46
	1.5	23	1.28	0.47	0.54
	2.0	27	1.69	0.45	0.52
	3.0	31	2.60	0.52	0.60
	4.0	33	3.58	0.63	0.73
45	0.75	17	0.77	0.51	0.59
	1.0	21	1.06	0.46	0.53
	1.5	24	1.48	0.49	0.57
	2.0	27	1.93	0.51	0.59
	3.0	31	3.00	0.60	0.69
	4.0	35	4.13	0.65	0.75
55	0.75	18	0.85	0.51	0.58
	1.0	22	1.18	0.47	0.54
	1.5	24	1.65	0.55	0.64
	2.0	28	2.15	0.53	0.61
	3.0	32	3.25	0.61	0.71
	4.0	35	4.60	0.72	0.83

Precipitation rates based on half-circle operation

■ Square spacing based on 50% diameter of throw

▲ Triangular spacing based on 50% diameter of throw

Performance data collected in zero wind conditions

Performance data derived from tests that conform with ASABE Standards; ASABE S398.1.

See page 177 for complete ASABE Test Certification Statement.

3504 Series Nozzle Performance					METRIC	
Pressure bar	Nozzle	Radius m	Flow m ³ /h	Flow l/m	■ Precip mm/h	▲ Precip mm/h
1.7	0.75	4.6	0.12	2.04	12	14
	1.0	6.1	0.17	2.91	9	11
	1.5	7.0	0.24	4.01	10	11
	2.0	8.2	0.32	5.30	9	11
	3.0	8.8	0.49	8.21	13	15
	4.0	9.4	0.67	11.24	15	17
2.0	0.75	4.8	0.13	2.24	12	13
	1.0	6.2	0.19	3.14	10	11
	1.5	7.0	0.26	4.35	11	12
	2.0	8.2	0.34	5.74	10	12
	3.0	9.1	0.53	8.87	13	15
	4.0	9.7	0.73	12.17	16	18
2.5	0.75	5.2	0.16	2.58	12	13
	1.0	6.4	0.21	3.55	10	12
	1.5	7.0	0.30	4.94	12	14
	2.0	8.2	0.39	6.51	12	13
	3.0	9.4	0.60	10.03	13	16
	4.0	10.1	0.83	13.82	16	19
3.0	0.75	5.2	0.17	2.86	13	15
	1.0	6.4	0.24	3.93	12	13
	1.5	7.3	0.33	5.49	12	14
	2.0	8.2	0.43	7.17	13	15
	3.0	9.4	0.67	11.13	15	17
	4.0	10.6	0.92	15.32	16	19
3.5	0.75	5.4	0.19	3.09	13	15
	1.0	6.6	0.26	4.27	12	14
	1.5	7.3	0.36	5.97	13	15
	2.0	8.4	0.47	7.79	13	15
	3.0	9.6	0.71	11.90	15	18
	4.0	10.7	1.00	16.66	18	20
3.8	0.75	5.5	0.19	3.22	13	15
	1.0	6.7	0.27	4.47	12	14
	1.5	7.3	0.37	6.25	14	16
	2.0	8.5	0.49	8.14	13	15
	3.0	9.8	0.74	12.30	16	18
	4.0	10.7	1.04	17.41	18	21

5000 Series

Engineered to be the Industry's Most Reliable and Best Performing Rotor

Features

- Oversized wiper seal prevents leaks and protects internals from debris
- Rain Curtain™ nozzles deliver even distribution over the entire radius including large wind resistant droplets and gentle close-in watering resulting in greener turf using less water
- A history of proven performance and reliability tested in millions of installations
- Self-flushing arc adjustment port that prevents buildup of debris
- 5 year trade warranty

Operating Specifications

- Precipitation rate: 0.20 to 1.01 in/hr (5 to 26 mm/h)
- Radius: 15 to 35 feet (4.6 to 10.7 m)
- Radius may be reduced up to 25% with radius reduction screw
- Pressure: 25 to 65 psi (1.7 to 4.5 bar)
- Flow Rate: 0.76 to 9.63 gpm (3.0 to 36.6 l/m; 0.17 to 2.19 m³/h)

Optional Features

- All features of the 5000 Series plus:
 - **Plus (PL) Flow shutoff** – “The Green Top.” Reduce downtime on jobs by flushing and nozzling rotors without running back and forth to the controller or valves
 - **PRS (R)** with flow optimizer technology. The 45 psi pressure regulator lowers water bills, provides exact flow of each rotor, equalizes lateral lines, and eliminates misting and fogging
 - **SAM Seal-A-Matic** check valve
 - **Stainless steel (SS) riser** helps deter vandalism on public turf areas (available on 4 and 6" models)
 - **Purple cover (NP)** for non-potable systems



Rotors

5000 Series (cont.)

Models

Part-circle units (PC) are adjustable from 40 –360 degrees.
Full-circle units (FC) are 360 degrees only.

- 5004PC: 5004 Part Circle
- 5004PC20: 5004 Part Circle w/2.0 Nozzle
- 5004PC30: 5004 Part Circle w/3.0 Nozzle
- 5004PLPC: 5004 Plus Part Circle
- 5004PLPC20: 5004 Plus Part Circle w/2.0 Nozzle
- 5004PLPC30: 5004 Plus Part Circle w/3.0 Nozzle
- 5004FC: 5004 Full Circle
- 5004PLFC: 5004 Plus Full Circle
- 5004PLFCS: 5004 Plus Full Circle SAM
- 5004PCSAM: 5004 Part Circle SAM
- 5004PCSAM: 5004 Part Circle SAM w/2.0 Nozzle
- 5004PCSAM: 5004 Part Circle SAM w/3.0 Nozzle
- 5004PC: 5004 Part Circle Non Potable
- 5004PCR: 5004 Part Circle PRS
- 5004PCR: 5004 Part Circle PRS w/ 2.0 Nozzle
- 5004PCR: 5004 Part Circle PRS w/ 3.0 Nozzle
- 5004PLPCS: 5004 Plus Part Circle SAM
- 5004PCSAM: 5004 Part Circle SAM w/2.0 Nozzle
- 5004PCSAM: 5004 Part Circle SAM w/3.0 Nozzle

- 5004+PCR: 5004 Plus Part Circle PRS
- 5004+PCSR: 5004 Plus Part Circle SAM PRS
- 5004+PCSR: 5004 Plus Part Circle SAM PRS w/2.0 Nozzle
- 5004+PCSR: 5004 Plus Part Circle SAM PRS w/3.0 Nozzle
- 5004+PCSR: 5004 Plus Part Circle SAM PRS Non Potable
- 5004+PCSR: 5004 Plus Part Circle SAM PRS Stainless Steel
- 5004+PCSR: 5004 Plus Part Circle SAM PRS Stainless Steel Non Potable
- 5004+FCSR: 5004 Plus Full Circle SAM PRS
- 5004+FCSR: 5004 Plus Full Circle Stainless Steel SAM PRS
- 5006PC: 5006 Part Circle
- 5006PC: 5006 Part Circle w/ 3.0 Nozzle
- 5006PLPC: 5006 Plus Part Circle
- 5006PLPCS: 5006 Plus Part Circle SAM
- 5006PLPCS: 5006 Plus Part Circle SAM Non Potable
- 5006+PCSR: 5006 Plus Part Circle SAM PRS
- 5006+PCSR: 5006 Plus Part Circle SAM PRS Non Potable
- 5006+PCSR: 5006 Plus Part Circle SAM PRS Stainless Steel
- 5006+PCSR: 5006 Plus Part Circle SAM PRS Stainless Steel Non Potable
- 5012+PCSR: 5012 Plus Part Circle SAM PRS
- 5012+PCSR: 5012 Plus Part Circle SAM PRS Non Potable

Three steps to specification:

1. Choose your rotor model and size.
2. Choose arc setting PC/FC.
3. Add available options or pre-installed nozzles.

	Model/Size (Choose 1)	Part or Full Circle (Choose 1)	Available Options (Optional Choices)	Pre-Installed nozzles (Optional Choices)	Specification Notes
Closed Case Rotors	3500 (shrub) 3504		SAM NP		Part circle & reversing full circle
	5000 (shrub) 5004 5006 5012	PC FC	SAM Plus PRS SS NP	2.0 3.0	PC only on 5000, 5006 and 5012 models
	6504	PC FC	SS NP HS		SAM standard.
	8005		SS NP		Part circle and non-reversing full circle in one head. SAM standard.
Open Case Rotors	Maxi-Paw		SAM NP		Part circle and non-reversing full circle in one head.

PC Part Circle & Reversing Full Circle
FC Non-Reversing Full Circle

SAM Check valve
Plus Flow shut-off
PRS Pressure Regulation

SS Stainless Steel
NP Non-Potable ID
HS High Speed

5000 Series Std. Angle Rain Curtain™ Nozzle Performance					
Pressure psi	Nozzle	Radius ft.	Flow gpm	■ Precip In/h	▲ Precip In/h
25	1.5	33	1.12	0.20	0.23
	2.0	35	1.50	0.24	0.27
	2.5	35	1.81	0.28	0.33
	3.0	36	2.26	0.34	0.39
	4.0	37	2.91	0.41	0.47
	5.0	39	3.72	0.47	0.54
	6.0	39	4.25	0.54	0.62
	8.0	36	5.90	0.88	1.01
35	1.5	34	1.35	0.22	0.26
	2.0	36	1.81	0.27	0.31
	2.5	37	2.17	0.31	0.35
	3.0	38	2.71	0.36	0.42
	4.0	40	3.50	0.42	0.49
	5.0	41	4.47	0.51	0.59
	6.0	43	5.23	0.54	0.63
	8.0	43	7.06	0.74	0.85
45	1.5	35	1.54	0.24	0.28
	2.0	37	2.07	0.29	0.34
	2.5	37	2.51	0.35	0.41
	3.0	40	3.09	0.37	0.43
	4.0	42	4.01	0.44	0.51
	5.0	45	5.09	0.48	0.56
	6.0	46	6.01	0.55	0.63
	8.0	47	8.03	0.70	0.81
55	1.5	35	1.71	0.27	0.31
	2.0	37	2.30	0.32	0.37
	2.5	37	2.76	0.39	0.45
	3.0	40	3.47	0.42	0.48
	4.0	42	4.44	0.48	0.56
	5.0	45	5.66	0.54	0.62
	6.0	47	6.63	0.58	0.67
	8.0	50	8.86	0.68	0.79
65	1.5	34	1.86	0.31	0.36
	2.0	35	2.52	0.40	0.46
	2.5	37	3.01	0.42	0.49
	3.0	40	3.78	0.45	0.53
	4.0	42	4.83	0.53	0.61
	5.0	45	6.16	0.59	0.68
	6.0	48	7.22	0.60	0.70
	8.0	50	9.63	0.74	0.86

Precipitation rates based on half-circle operation

■ Square spacing based on 50% diameter of throw

▲ Triangular spacing based on 50% diameter of throw

Performance data collected in zero wind conditions

Performance data derived from tests that conform with ASABE Standards; ASABE S398.1. See page 177 for complete ASABE Test Certification Statement.

5000 Series Std. Angle Rain Curtain™ Nozzle Performance						
Pressure bar	Nozzle	Radius m	Flow m ³ /h	Flow l/m	■ Precip mm/h	▲ Precip mm/h
2.0	1.5	10.2	0.28	4.8	5	6
	2.0	10.8	0.36	6.0	6	7
	2.5	10.9	0.44	7.2	7	9
	3.0	11.2	0.55	9.0	9	10
	4.0	11.6	0.71	12.0	11	12
	5.0	12.1	0.91	15.0	12	14
	6.0	12.4	1.05	17.4	14	16
	8.0	11.8	1.45	24.0	21	24
2.5	1.5	10.4	0.31	5.4	6	7
	2.0	11.0	0.41	6.6	7	8
	2.5	11.3	0.50	8.4	8	9
	3.0	11.2	0.62	10.2	9	11
	4.0	12.3	0.81	13.2	11	13
	5.0	12.7	1.03	17.4	13	15
	6.0	13.2	1.21	20.4	14	16
	8.0	13.3	1.63	27.0	19	21
3.0	1.5	10.6	0.34	6.0	6	7
	2.0	11.2	0.45	7.8	7	8
	2.5	11.3	0.56	9.6	9	10
	3.0	12.1	0.69	11.4	9	11
	4.0	12.7	0.89	15.0	11	13
	5.0	13.5	1.13	18.6	12	14
	6.0	13.9	1.34	22.2	14	16
	8.0	14.1	1.79	30.0	18	21
3.5	1.5	10.7	0.37	6.0	7	8
	2.0	11.3	0.49	8.4	8	9
	2.5	11.3	0.60	10.2	9	11
	3.0	12.2	0.74	12.6	10	12
	4.0	12.8	0.97	16.2	12	14
	5.0	13.7	1.23	20.4	13	15
	6.0	14.2	1.45	24.0	14	17
	8.0	14.9	1.93	32.4	18	20
4.0	1.5	10.6	0.40	6.6	7	8
	2.0	11.1	0.52	9.0	8	10
	2.5	11.3	0.64	10.8	10	12
	3.0	12.2	0.80	13.2	11	12
	4.0	12.8	1.04	17.4	13	15
	5.0	13.7	1.32	22.2	14	16
	6.0	14.9	1.55	25.8	15	17
	8.0	15.2	2.06	34.2	18	21
4.5	1.5	10.4	0.42	7.2	8	9
	2.0	10.7	0.55	9.0	10	11
	2.5	11.3	0.68	11.4	11	12
	3.0	12.2	0.84	13.8	11	13
	4.0	12.8	1.10	18.0	13	15
	5.0	13.7	1.40	23.4	15	17
	6.0	14.6	1.64	28.2	15	18
	8.0	15.2	2.19	36.6	19	22

Rotors

5000 Series Low Angle Nozzle Performance					
Pressure psi	Nozzle	Radius ft.	Flow gpm	■ Precip In/h	▲ Precip In/h
25	1.0 LA	25	0.76	0.23	0.27
	1.5 LA	27	1.15	0.30	0.35
	2.0 LA	29	1.47	0.34	0.39
	3.0 LA	29	2.23	0.51	0.59
35	1.0 LA	28	0.92	0.23	0.26
	1.5 LA	30	1.38	0.30	0.34
	2.0 LA	31	1.77	0.35	0.41
	3.0 LA	33	2.68	0.47	0.55
45	1.0 LA	29	1.05	0.24	0.28
	1.5 LA	31	1.58	0.32	0.37
	2.0 LA	32	2.02	0.38	0.44
	3.0 LA	35	3.07	0.48	0.56
55	1.0 LA	29	1.17	0.27	0.31
	1.5 LA	31	1.76	0.35	0.41
	2.0 LA	33	2.24	0.40	0.46
	3.0 LA	36	3.41	0.51	0.58
65	1.0 LA	29	1.27	0.29	0.34
	1.5 LA	31	1.92	0.38	0.44
	2.0 LA	33	2.45	0.43	0.50
	3.0 LA	36	3.72	0.55	0.64

5000 Series Low Angle Nozzle Performance						METRIC
Pressure bar	Nozzle	Radius m	Flow m ³ /h	Flow l/m	■ Precip mm/h	▲ Precip mm/h
1.7	1.0 LA	7.6	0.17	3.0	6	7
	1.5 LA	8.2	0.26	4.2	8	9
	2.0 LA	8.8	0.33	5.4	9	10
	3.0 LA	8.8	0.51	8.4	13	15
2.0	1.0 LA	8.0	0.18	3.0	6	6
	1.5 LA	8.6	0.28	4.8	8	9
	2.0 LA	9.1	0.36	6.0	9	10
	3.0 LA	9.3	0.55	9.0	13	15
2.5	1.0 LA	8.6	0.20	3.6	5	6
	1.5 LA	9.2	0.32	5.4	8	9
	2.0 LA	9.5	0.41	6.6	9	10
	3.0 LA	10.1	0.62	10.2	12	14
3.0	1.0 LA	8.8	0.22	3.6	6	7
	1.5 LA	9.4	0.35	6.0	8	9
	2.0 LA	9.7	0.45	7.8	10	11
	3.0 LA	10.6	0.68	11.4	12	14
3.5	1.0 LA	8.8	0.24	4.2	6	7
	1.5 LA	9.4	0.38	6.6	9	10
	2.0 LA	9.9	0.49	8.4	10	11
	3.0 LA	10.8	0.74	12.6	13	15
4.0	1.0 LA	8.8	0.26	4.2	7	8
	1.5 LA	9.4	0.41	6.6	9	11
	2.0 LA	10.1	0.52	9.0	10	12
	3.0 LA	11.0	0.80	13.2	13	15
4.5	1.0 LA	8.8	0.27	4.8	7	8
	1.5 LA	9.4	0.44	7.2	10	11
	2.0 LA	10.1	0.56	9.0	11	13
	3.0 LA	11.0	0.84	13.8	14	16

Precipitation rates based on half-circle operation

■ Square spacing based on 50% diameter of throw

▲ Triangular spacing based on 50% diameter of throw

Performance data collected in zero wind conditions

Performance data derived from tests that conform with ASABE Standards; ASABE S398.1.

See page 177 for complete ASABE Test Certification Statement.

Holdup Tool with Bubble Level

Features

- Combination holdup tool/ bubble level makes proper installation easier
- Works with 5000, 5500, Falcon® 6504, and 8005



HOLDUPTOOL

ROTORTOOL

Features

- Flat blade screwdriver and pull-up tool all in one

Model

- ROTORTOOL



ROTORTOOL

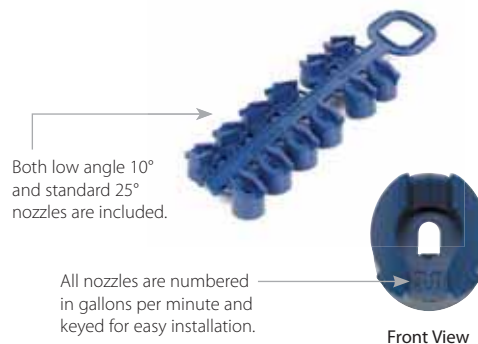

5000 PRS Std. Angle Rain Curtain™ Nozzle Performance					
Pressure psi	Nozzle	Radius ft.	Flow gpm	■ Precip In/h	▲ Precip In/h
25	1.5	33	1.12	0.2	0.23
	2.0	35	1.5	0.24	0.27
	2.5	35	1.81	0.28	0.33
	3.0	36	2.26	0.34	0.39
	4.0	37	2.91	0.41	0.47
	5.0	39	3.72	0.47	0.54
	6.0	39	4.25	0.54	0.62
	8.0	36	5.9	0.88	1.01
35	1.5	34	1.35	0.22	0.26
	2.0	36	1.81	0.27	0.31
	2.5	37	2.17	0.31	0.35
	3.0	38	2.71	0.36	0.41
	4.0	40	3.5	0.42	0.49
	5.0	41	4.47	0.51	0.59
	6.0	43	5.23	0.54	0.63
	8.0	43	7.06	0.74	0.85
45	1.5	35	1.54	0.24	0.28
	2.0	37	2.07	0.29	0.34
	2.5	37	2.51	0.35	0.41
	3.0	40	3.09	0.37	0.43
	4.0	42	4.01	0.44	0.51
	5.0	45	5.09	0.48	0.56
	6.0	46	6.01	0.55	0.63
	8.0	47	8.03	0.7	0.81
55 – 75	1.5	35	1.59	0.25	0.29
	2.0	37	2.14	0.3	0.35
	2.5	37	2.6	0.37	0.42
	3.0	40	3.2	0.39	0.44
	4.0	42	4.15	0.45	0.52
	5.0	45	5.27	0.5	0.58
	6.0	46	6.22	0.57	0.65
	8.0	47	8.31	0.72	0.84

Precipitation rates based on half-circle operation

■ Square spacing based on 50% diameter of throw

▲ Triangular spacing based on 50% diameter of throw

Performance data collected in zero wind conditions

Performance data derived from tests that conform with ASABE Standards; ASABE S398.1.

See page 177 for complete ASABE Test Certification Statement.

5000 PRS Std. Angle Rain Curtain™ Nozzle Performance						METRIC
Pressure bar	Nozzle	Radius m	Flow m ³ /h	Flow l/m	■ Precip mm/h	▲ Precip mm/h
1.7	1.5	10.1	0.25	4.2	5	6
	2.0	10.7	0.34	5.4	6	7
	2.5	10.7	0.41	6.6	7	8
	3.0	11.0	0.51	8.4	8	10
	4.0	11.3	0.66	10.8	10	12
	5.0	11.9	0.84	13.8	12	14
	6.0	11.9	0.97	16.2	14	16
	8.0	11.0	1.34	22.2	22	26
2.0	1.5	10.2	0.28	4.8	5	6
	2.0	10.8	0.36	6.0	6	7
	2.5	10.9	0.44	7.2	7	9
	3.0	11.2	0.55	9.0	9	10
	4.0	11.6	0.71	12.0	11	12
	5.0	12.1	0.91	15.0	12	14
	6.0	12.4	1.05	17.4	14	16
	8.0	11.8	1.45	24.0	21	24
2.5	1.5	10.4	0.31	5.4	6	7
	2.0	11.0	0.41	6.6	7	8
	2.5	11.3	0.50	8.4	8	9
	3.0	11.2	0.62	10.2	9	11
	4.0	12.3	0.81	13.2	11	13
	5.0	12.7	1.03	17.4	13	15
	6.0	13.2	1.21	20.4	14	16
	8.0	13.3	1.63	27.0	19	21
3.0	1.5	10.6	0.34	6.0	6	7
	2.0	11.2	0.45	7.8	7	8
	2.5	11.3	0.56	9.6	9	10
	3.0	12.1	0.69	11.4	9	11
	4.0	12.7	0.89	16.8	11	13
	5.0	13.5	1.13	18.6	12	14
	6.0	13.9	1.34	22.2	14	16
	8.0	14.1	1.79	30.0	18	21
3.5 – 5.2	1.5	10.6	0.35	6.0	6	7
	2.0	11.2	0.47	7.8	8	9
	2.5	11.3	0.58	10.2	9	11
	3.0	12.1	0.71	12.0	10	11
	4.0	12.7	0.92	15.6	12	13
	5.0	13.5	1.17	19.2	13	15
	6.0	13.9	1.39	22.8	14	17
	8.0	14.1	1.85	31.2	18	21

Rotors

5000 PRS Low Angle Nozzle Performance					
Pressure psi	Nozzle	Radius ft.	Flow gpm	■ Precip In/h	▲ Precip In/h
25	1.0 LA	25	0.76	0.22	0.26
	1.5 LA	27	1.15	0.3	0.35
	2.0 LA	29	1.47	0.34	0.39
	3.0 LA	29	2.23	0.51	0.59
35	1.0 LA	28	0.92	0.21	0.25
	1.5 LA	30	1.38	0.3	0.34
	2.0 LA	31	1.77	0.35	0.41
	3.0 LA	33	2.68	0.47	0.55
45	1.0 LA	29	1.05	0.23	0.26
	1.5 LA	31	1.58	0.32	0.37
	2.0 LA	32	2.02	0.38	0.44
	3.0 LA	35	3.07	0.48	0.56
55 - 75	1.0 LA	29	1.09	0.25	0.29
	1.5 LA	31	1.64	0.33	0.38
	2.0 LA	32	2.09	0.39	0.45
	3.0 LA	35	3.18	0.5	0.58

5000 PRS Low Angle Nozzle Performance					METRIC	
Pressure bar	Nozzle	Radius m	Flow m ³ /h	Flow l/m	■ Precip mm/h	▲ Precip mm/h
1.7	1.0 LA	7.6	0.17	3.0	6	7
	1.5 LA	8.2	0.26	4.2	8	9
	2.0 LA	8.8	0.33	5.4	9	10
	3.0 LA	8.8	0.51	8.4	13	15
2.0	1.0 LA	8.0	0.18	3.0	6	6
	1.5 LA	8.6	0.28	4.8	8	9
	2.0 LA	9.1	0.36	6.0	9	10
	3.0 LA	9.3	0.55	9.0	13	15
2.5	1.0 LA	8.6	0.20	3.6	5	6
	1.5 LA	9.2	0.32	5.4	8	9
	2.0 LA	9.5	0.41	6.6	9	10
	3.0 LA	10.1	0.62	10.2	12	14
3.0	1.0 LA	8.8	0.22	3.6	6	7
	1.5 LA	9.4	0.35	6.0	8	9
	2.0 LA	9.7	0.45	7.8	10	11
	3.0 LA	10.6	0.68	11.4	12	14
3.5 - 5.2	1.0 LA	8.8	0.23	3.6	6	7
	1.5 LA	9.4	0.36	6.0	8	10
	2.0 LA	9.7	0.47	7.8	10	12
	3.0 LA	10.6	0.70	12.0	13	15

Precipitation rates based on half-circle operation

■ Square spacing based on 50% diameter of throw

▲ Triangular spacing based on 50% diameter of throw

Performance data collected in zero wind conditions

Performance data derived from tests that conform with ASABE Standards; ASABE S398.1.

See page 177 for complete ASABE Test Certification Statement.

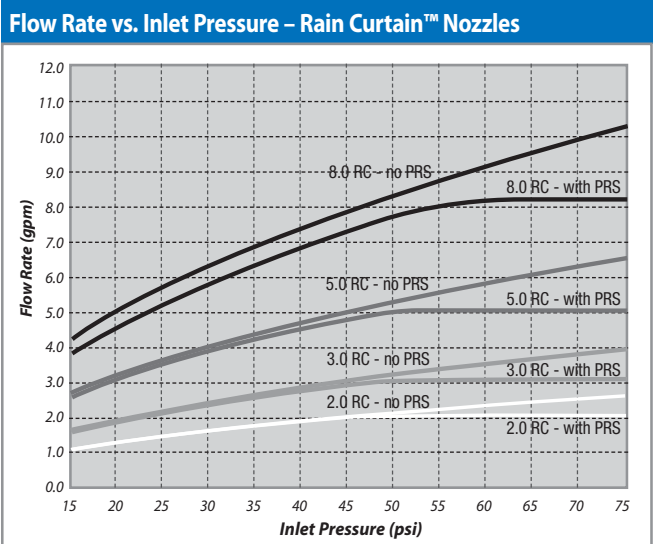

How much water can you save each minute using Rain Bird® 5000 PRS Rotors with Flow Optimizer Technology?								
Flow GPM	45	50	55	60	65	70	75	80
6	0	0.33	0.66	0.96	1.25	1.54	1.81	2.06
8	0	0.43	0.85	1.24	1.62	1.98	2.33	2.67
10	0	0.55	1.07	1.57	2.05	2.52	2.96	3.39
12	0	0.66	1.27	1.86	2.43	2.97	3.50	4.01
14	0	0.77	1.49	2.18	2.84	3.48	4.10	4.70
16	0	0.87	1.69	2.48	3.24	3.97	4.67	5.35
18	0	0.98	1.90	2.79	3.64	4.46	5.25	6.01
20	0	1.10	2.12	3.10	4.05	4.96	5.83	6.68
22	0	1.21	2.33	3.42	4.46	5.47	6.44	7.37
24	0	1.30	2.54	3.72	4.85	5.94	7.00	8.01
26	0	1.41	2.76	4.04	5.27	6.45	7.60	8.70
28	0	1.53	2.96	4.34	5.66	6.93	8.16	9.35
30	0	1.63	3.17	4.65	6.07	7.43	8.74	10.02

Total gallons of water saved per minute of run time

Ex: At 70 psi a zone with 20 gpm of flow would save 4.96 gallons a minute with 5000 PRS

5000 Series MPR Nozzles

Perfectly Balanced Coverage with the 5000 Series Rotor

Features

- Rain Curtain™ nozzles deliver even distribution over the entire radius including large wind resistant droplets and gentle close-in watering resulting in greener turf using less water
- Precipitation rate is automatically matched with a uniform radius that does not require stream deflection
- Matched 0.6"/hour precipitation rates enable large and small turf areas to be zoned together by mixing rotors and Rain Bird R-VAN or R-Series rotary nozzles





Models



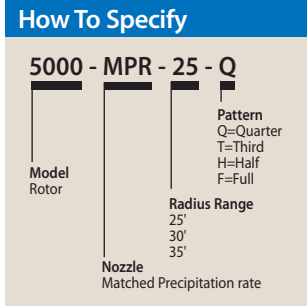

- 5000MPRMPK: 5000/5000 Plus Series MPR nozzle tree multi pack- 25', 30', 35' radius in Quarter, Third, Half, Full arc











5000 Series MPR Nozzles











5000-MPR-25 (Red)						
Nozzle	Pressure psi	Radius ft.	Flow gpm	Precip In/h	Precip In/h	
Quarter 	25	23	0.74	0.54	0.62	
	35	24	0.88	0.59	0.68	
	45	25	1.00	0.62	0.71	
	55	25	1.11	0.68	0.79	
	65	25	1.21	0.75	0.86	
Third 	25	23	1.00	0.55	0.63	
	35	24	1.21	0.61	0.70	
	45	25	1.38	0.64	0.74	
	55	25	1.53	0.71	0.82	
	65	25	1.67	0.77	0.89	
Half 	25	23	1.44	0.52	0.61	
	35	24	1.73	0.58	0.67	
	45	25	1.98	0.61	0.70	
	55	25	2.21	0.68	0.79	
	65	25	2.41	0.74	0.86	
Full 	25	23	2.78	0.51	0.58	
	35	24	3.34	0.56	0.64	
	45	25	3.82	0.59	0.68	
	55	25	4.25	0.65	0.76	
	65	25	4.63	0.71	0.82	

5000-MPR-25 (Red) METRIC						
Nozzle	Pressure bar	Radius m	Flow m ³ /h	Flow l/m	Precip mm/h	Precip mm/h
Quarter 	1.7	7.0	0.17	3.0	13.7	15.8
	2.4	7.3	0.20	3.6	14.9	17.3
	3.1	7.6	0.23	3.6	15.6	18.1
	3.8	7.6	0.25	4.2	17.4	20.1
	4.5	7.6	0.27	4.8	18.9	21.9
Third 	1.7	7.0	0.23	3.6	13.9	16.0
	2.4	7.3	0.27	4.8	15.4	17.8
	3.1	7.6	0.31	5.4	16.2	18.7
	3.8	7.6	0.35	6.0	18.0	20.7
	4.5	7.6	0.38	6.6	19.6	22.6
Half 	1.7	7.0	0.33	5.4	13.3	15.4
	2.4	7.3	0.39	6.6	14.7	17.0
	3.1	7.6	0.45	7.2	15.5	17.9
	3.8	7.6	0.50	8.4	17.3	20.0
	4.5	7.6	0.55	9.0	18.9	21.8
Full 	1.7	7.0	0.63	10.8	12.8	14.8
	2.4	7.3	0.76	12.6	14.2	16.4
	3.1	7.6	0.87	14.4	14.9	17.3
	3.8	7.6	0.97	16.2	16.6	19.2
	4.5	7.6	1.05	17.4	18.1	20.9

5000-MPR-30 (Green)					
Nozzle	Pressure psi	Radius ft.	Flow gpm	■ Precip In/h	▲ Precip In/h
 Quarter	25	29	1.03	0.47	0.54
	35	30	1.23	0.53	0.61
	45	30	1.40	0.60	0.69
	55	30	1.56	0.67	0.77
	65	30	1.69	0.72	0.83
 Third	25	29	1.34	0.46	0.53
	35	30	1.62	0.52	0.60
	45	30	1.85	0.59	0.69
	55	30	2.06	0.66	0.76
	65	30	2.24	0.72	0.83
 Half	25	29	2.15	0.49	0.57
	35	30	2.59	0.55	0.64
	45	30	2.96	0.63	0.73
	55	30	3.30	0.71	0.82
	65	30	3.60	0.77	0.89
 Full	25	29	4.24	0.49	0.56
	35	30	5.08	0.54	0.63
	45	30	5.78	0.62	0.71
	55	30	6.39	0.68	0.79
	65	30	6.92	0.74	0.85

5000-MPR-30 (Green)					METRIC	
Nozzle	Pressure bar	Radius m	Flow m ³ /h	Flow l/m	■ Precip mm/h	▲ Precip mm/h
 Quarter	1.7	8.8	0.23	3.6	12.0	13.8
	2.4	9.1	0.28	4.8	13.4	15.4
	3.1	9.1	0.32	5.4	15.2	17.6
	3.8	9.1	0.35	6.0	17.0	19.6
	4.5	9.1	0.38	6.6	18.4	21.2
 Third	1.7	8.8	0.30	4.8	11.7	13.5
	2.4	9.1	0.37	6.0	13.2	15.2
	3.1	9.1	0.42	7.2	15.1	17.4
	3.8	9.1	0.47	7.8	16.8	19.4
	4.5	9.1	0.51	8.4	18.3	21.1
 Half	1.7	8.8	0.49	8.4	12.5	14.4
	2.4	9.1	0.59	9.6	14.1	16.2
	3.1	9.1	0.67	11.4	16.1	18.6
	3.8	9.1	0.75	12.6	17.9	20.7
	4.5	9.1	0.82	13.8	19.6	22.6
 Full	1.7	8.8	0.96	16.2	12.3	14.2
	2.4	9.1	1.15	19.2	13.8	15.9
	3.1	9.1	1.31	21.6	15.7	18.1
	3.8	9.1	1.45	24.0	17.4	20.0
	4.5	9.1	1.57	26.4	18.8	21.7

5000-MPR-35 (Beige)					
Nozzle	Pressure psi	Radius ft.	Flow gpm	■ Precip In/h	▲ Precip In/h
 Quarter	25	32	1.40	0.53	0.61
	35	34	1.67	0.56	0.64
	45	35	1.92	0.60	0.70
	55	35	2.13	0.67	0.77
	65	35	2.31	0.73	0.84
 Third	25	32	1.77	0.50	0.58
	35	34	2.15	0.54	0.62
	45	35	2.46	0.58	0.67
	55	35	2.74	0.65	0.75
	65	35	2.99	0.70	0.81
 Half	25	32	2.75	0.52	0.60
	35	34	3.33	0.55	0.64
	45	35	3.81	0.60	0.69
	55	35	4.23	0.66	0.77
	65	35	4.62	0.73	0.84
 Full	25	32	5.36	0.50	0.58
	35	34	6.62	0.55	0.64
	45	35	7.58	0.60	0.69
	55	35	8.43	0.66	0.76
	65	35	9.18	0.72	0.83

5000-MPR-35 (Beige)					METRIC	
Nozzle	Pressure bar	Radius m	Flow m ³ /h	Flow l/m	■ Precip mm/h	▲ Precip mm/h
 Quarter	1.7	9.8	0.32	5.4	13.4	15.4
	2.4	10.4	0.38	6.6	14.1	16.3
	3.1	10.7	0.44	7.2	15.3	17.7
	3.8	10.7	0.48	7.8	17.0	19.6
	4.5	10.7	0.52	9.0	18.4	21.3
 Third	1.7	9.8	0.40	6.6	12.7	14.6
	2.4	10.4	0.49	8.4	13.6	15.8
	3.1	10.7	0.56	9.6	14.7	17.0
	3.8	10.7	0.62	10.2	16.4	18.9
	4.5	10.7	0.68	11.4	17.9	20.7
 Half	1.7	9.8	0.62	10.2	13.1	15.2
	2.4	10.4	0.76	12.6	14.1	16.3
	3.1	10.7	0.87	14.4	15.2	17.6
	3.8	10.7	0.96	16.2	16.9	19.5
	4.5	10.7	1.05	17.4	18.4	21.3
 Full	1.7	9.8	1.22	20.4	12.8	14.8
	2.4	10.4	1.50	25.2	14.0	16.2
	3.1	10.7	1.72	28.8	15.1	17.5
	3.8	10.7	1.91	31.8	16.8	19.4
	4.5	10.7	2.09	34.8	18.3	21.2

■ Square spacing based on 50% diameter of throw
▲ Triangular spacing based on 50% diameter of throw
Performance data collected in zero wind conditions

Performance data derived from tests that conform with ASABE Standards; ASABE S398.1.
See page 177 for complete ASABE Test Certification Statement.

Falcon® 6504 Series

Reliable and Economical

Features

- Ratcheting stem just like standard spray bodies
- 3-port, color-coded Rain Curtain nozzles for optimal long range, mid-range, and close-in watering
- SAM Seal-A-Matic check valve
- Self-adjusting stator does not require replacement when changing nozzles
- Heavy-duty, stainless steel retract spring ensures positive pop down
- 5 year warranty

Options

- **Stainless steel (SS)** riser helps deter vandalism on public turf areas
- **Purple cover (NP)** for non-potable systems
- **High Speed (HS)** "Tan Top" version for dust suppression

Operating Specifications

- Precipitation rate: 0.37 to 1.14 inches per hour (9 to 29 mm/h)
- Radius: 39 to 65 feet (11.9 to 19.8 m)
- Pressure: 30 to 90 psi (2.1 to 6.2 bar)
- Flow: 2.9 to 21.7 gpm (0.66 to 4.93 m³/h; 10.8 to 82.2 l/m)
- 1" (26/34) female NPT or BSP threaded inlet
- SAM check device holds up to 10 feet (3.1 m) of elevation change
- Rain Curtain™ Nozzles: 04-black; 06-light blue; 08-dark green; 10-grey; 12-beige; 14-light green; 16-dark brown; 18-dark blue

Models

- F4-FC: Full-circle
- F4-PC: Part-circle
- F4-FC-NP: Full-circle, non-potable cover
- F4-PC-NP: Part-circle, non-potable cover
- F4-FC-SS: Full-circle, stainless steel
- F4-PC-SS: Part-circle, stainless steel
- F4-FC-SS-HS: Full-circle, stainless steel, high speed rotation
- F4-PC-SS-HS: Part-circle, stainless steel, high speed rotation
- F4-FC-SS-NP: Full-circle, stainless steel, non-potable cover
- F4-PC-SS-NP: Part-circle, stainless steel, non-potable cover

Note: All models available with BSP threads



Falcon® 6504 Series

 0.37 to 1.14 in/hr
(9 to 29 mm/h)

 30 to 90 psi
(2.1 to 6.2 bar)

 2.9 to 21.7 gpm
(10.8 to 82.2 l/m)
(0.66 to 4.93 m³/h)

 4" (10.2 cm)
8½" (21.6 cm)
1" (26/34) NPT
or BSP

How To Specify

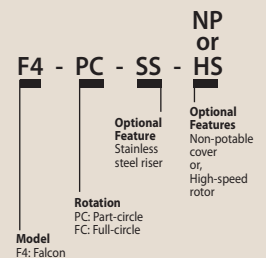

Note: For non-U.S. applications, it is necessary to specify NPT or BSP thread type.



Falcon® 6504 Nozzle Performance						
Pressure psi	Nozzle	Radius ft.	Flow gpm	■ Precip In/h	▲ Precip In/h	
30	● 4	39	2.9	0.37	0.42	
	● 6	43	4.2	0.44	0.50	
40	● 4	41	3.3	0.38	0.44	
	● 6	45	4.9	0.47	0.54	
	● 8	49	6.6	0.53	0.61	
	● 10	51	8.1	0.60	0.69	
	● 12	53	9.7	0.66	0.77	
	● 14	55	11.3	0.72	0.83	
	● 16	55	12.6	0.80	0.93	
	● 18	59	13.7	0.76	0.87	
50	● 4	41	3.7	0.42	0.49	
	● 6	49	5.5	0.44	0.51	
	● 8	51	7.4	0.55	0.63	
	● 10	53	9.1	0.62	0.72	
	● 12	55	11.0	0.70	0.81	
	● 14	59	12.7	0.70	0.81	
	● 16	61	14.3	0.74	0.85	
	● 18	59	15.4	0.85	0.98	
60	● 4	41	4.0	0.46	0.53	
	● 6	47	6.0	0.52	0.60	
	● 8	51	8.2	0.61	0.70	
	● 10	55	10.0	0.64	0.73	
	● 12	57	12.2	0.72	0.83	
	● 14	61	14.0	0.72	0.84	
	● 16	63	15.7	0.76	0.88	
	● 18	63	17.1	0.83	0.96	
70	● 4	41	4.4	0.50	0.58	
	● 6	49	6.3	0.51	0.58	
	● 8	51	8.9	0.66	0.76	
	● 10	57	10.8	0.64	0.74	
	● 12	59	13.2	0.73	0.84	
	● 14	61	15.2	0.79	0.91	
	● 16	63	16.9	0.82	0.95	
	● 18	65	18.3	0.83	0.96	
80	● 4	43	4.6	0.48	0.55	
	● 6	49	6.9	0.55	0.64	
	● 8	53	9.4	0.64	0.74	
	● 10	55	11.6	0.74	0.85	
	● 12	61	14.0	0.72	0.84	
	● 14	61	16.2	0.84	0.97	
	● 16	63	18.1	0.88	1.01	
	● 18	65	19.6	0.89	1.03	
90	● 18	65	21.7	0.99	1.14	

Precipitation rates based on half-circle operation
 ■ Square spacing based on 50% diameter of throw
 ▲ Triangular spacing based on 50% diameter of throw

High-Speed Falcon® 6504 Nozzle Performance						
Pressure psi	Nozzle	Radius ft.	Flow gpm	■ Precip In/h	▲ Precip In/h	
30	● 4	37	3.0	0.42	0.49	
	● 6	39	4.3	0.54	0.63	
40	● 4	41	3.5	0.40	0.46	
	● 6	43	6.0	0.62	0.72	
	● 8	47	6.6	0.58	0.66	
	● 10	47	8.1	0.71	0.82	
	● 12	49	9.9	0.79	0.92	
	● 14	53	11.4	0.78	0.90	
	● 16	51	12.6	0.93	1.08	
	● 18	53	13.9	0.95	1.10	
50	● 4	41	3.7	0.42	0.49	
	● 6	45	5.6	0.53	0.62	
	● 8	49	7.5	0.60	0.69	
	● 10	49	9.2	0.74	0.85	
	● 12	53	11.2	0.77	0.89	
	● 14	53	12.9	0.88	1.02	
	● 16	53	14.3	0.98	1.13	
	● 18	55	15.6	0.99	1.15	
60	● 4	41	4.2	0.48	0.56	
	● 6	45	6.2	0.59	0.68	
	● 8	47	8.3	0.72	0.84	
	● 10	49	10.2	0.82	0.94	
	● 12	53	12.4	0.85	0.98	
	● 14	53	14.2	0.97	1.12	
	● 16	55	15.7	1.00	1.15	
	● 18	59	17.2	0.95	1.10	
70	● 4	41	4.6	0.53	0.61	
	● 6	43	6.7	0.70	0.81	
	● 8	49	9.0	0.72	0.83	
	● 10	51	11.1	0.82	0.95	
	● 12	55	13.5	0.86	0.99	
	● 14	53	15.3	1.05	1.21	
	● 16	57	17.1	1.01	1.17	
	● 18	59	18.6	1.03	1.19	
80	● 4	39	4.9	0.62	0.72	
	● 6	43	7.1	0.74	0.85	
	● 8	51	9.7	0.72	0.83	
	● 10	49	11.9	0.95	1.10	
	● 12	55	14.4	0.92	1.06	
	● 14	53	16.5	1.13	1.31	
	● 16	59	18.4	1.02	1.18	
	● 18	59	20.0	1.11	1.28	
90	● 18	61	21.3	1.10	1.27	

Performance data collected in zero wind conditions
 Performance data derived from tests that conform with ASABE Standards; ASABE S398.1.
 See page 177 for complete ASABE Test Certification Statement.

Falcon® 6504 Nozzle Performance					METRIC	
Pressure bar	Nozzle	Radius m	Flow m³/h	Flow l/m	■ Precip mm/h	▲ Precip mm/h
2.1	● 4	11.9	0.66	10.98	9	11
	● 6	13.1	0.95	15.90	11	13
2.5	● 4	12.3	0.72	11.92	10	11
	● 6	13.5	1.05	17.56	12	13
	● 8	14.9	1.50	25.20	13	16
	● 10	15.5	1.84	30.60	15	18
	● 12	16.2	2.20	36.60	17	19
	● 14	16.8	2.57	42.60	18	21
	● 16	16.8	2.86	47.40	20	24
3.0	● 4	12.5	0.78	13.02	10	12
	● 6	14.1	1.16	19.34	12	13
	● 8	15.1	1.56	26.04	14	16
	● 10	15.8	1.92	31.99	15	18
	● 12	16.4	2.31	38.44	17	20
	● 14	17.2	2.68	44.63	18	21
	● 16	17.4	3.00	49.95	20	23
3.5	● 4	12.5	0.85	14.09	11	13
	● 6	14.9	1.26	20.96	11	13
	● 8	15.5	1.69	28.24	14	16
	● 10	16.2	2.08	34.70	16	18
	● 12	16.8	2.52	41.98	18	21
	● 14	18.0	2.91	48.45	18	21
	● 16	18.6	3.27	54.53	19	22
4.0	● 4	12.5	0.89	14.91	11	13
	● 6	14.4	1.34	22.33	13	15
	● 8	15.5	1.83	30.44	15	17
	● 10	16.6	2.23	37.17	16	19
	● 12	17.3	2.72	45.28	18	21
	● 14	18.5	3.12	52.01	18	21
	● 16	19.1	3.50	58.37	19	22

Pressure bar	Nozzle	Radius m	Flow m³/h	Flow l/m	■ Precip mm/h	▲ Precip mm/h
4.5	● 4	12.5	0.96	15.94	12	14
	● 6	14.6	1.40	23.33	13	15
	● 8	15.5	1.95	32.43	16	19
	● 10	17.1	2.37	39.44	16	19
	● 12	17.7	2.89	48.17	18	21
	● 14	18.6	3.32	55.38	19	22
	● 16	19.2	3.71	61.82	20	23
5.0	● 4	12.7	1.01	16.84	13	15
	● 6	14.9	1.47	24.50	13	15
	● 8	15.7	2.05	34.16	17	19
	● 10	17.2	2.50	41.64	17	19
	● 12	18.1	3.04	50.72	19	21
	● 14	18.6	3.51	58.49	20	23
	● 16	19.2	3.91	65.11	21	24
5.5	● 4	13.1	1.04	17.39	12	14
	● 6	14.9	1.56	25.79	14	16
	● 8	16.1	2.13	35.54	16	19
	● 10	16.8	2.63	43.84	19	22
	● 12	18.6	3.18	52.92	18	21
	● 14	18.6	3.67	61.23	21	25
	● 16	19.2	4.10	68.40	22	26
6.0	● 18	19.8	4.79	79.77	24	28
6.2	● 18	19.8	4.93	82.13	25	29

Precipitation rates based on half-circle operation

■ Square spacing based on 50% diameter of throw

▲ Triangular spacing based on 50% diameter of throw

Performance data collected in zero wind conditions

Performance data derived from tests that conform with ASABE Standards; ASABE S398.1. See page 177 for complete ASABE Test Certification Statement.



Falcon® 6504 Rain Curtain™ Nozzles

High-Speed Falcon® 6504 Nozzle Performance						METRIC	
Pressure bar	Nozzle	Radius m	Flow m³/h	Flow l/m	■ Precip mm/h	▲ Precip mm/h	
2.1	● 4	11.3	0.68	11.35	11	12	
	● 6	11.9	0.98	15.90	14	16	
2.5	● 4	12.0	0.75	12.54	10	12	
	● 6	12.7	1.22	20.16	15	18	
	● 8	14.2	1.49	25.20	15	17	
	● 10	14.2	1.83	30.60	18	21	
	● 12	14.8	2.24	37.20	20	24	
	● 14	16.0	2.58	43.20	20	23	
	● 16	15.4	2.85	47.40	24	28	
	● 18	16.0	3.15	52.80	24	28	
3.0	● 4	12.5	0.81	13.51	10	12	
	● 6	13.3	1.33	22.18	15	17	
	● 8	14.5	1.57	26.18	15	17	
	● 10	14.5	1.93	32.12	18	21	
	● 12	15.4	2.35	39.20	20	23	
	● 14	16.2	2.71	48.09	21	24	
	● 16	15.8	3.00	49.95	24	28	
	● 18	16.4	3.29	54.87	25	28	
3.5	● 4	12.5	0.85	14.15	11	13	
	● 6	13.7	1.28	21.37	14	16	
	● 8	14.9	1.72	28.62	16	18	
	● 10	14.9	2.11	35.11	19	22	
	● 12	16.2	2.56	42.74	20	23	
	● 14	16.2	2.95	49.20	23	26	
	● 16	16.2	3.27	54.53	25	29	
	● 18	16.9	3.57	59.51	25	29	
4.0	● 4	12.5	0.93	15.52	12	14	
	● 6	13.7	1.38	23.02	15	17	
	● 8	14.4	1.85	30.81	18	21	
	● 10	14.9	2.27	37.86	20	24	
	● 12	16.2	2.76	46.03	21	24	
	● 14	16.2	3.17	52.77	24	28	
	● 16	16.6	3.50	58.37	25	29	
	● 18	17.7	3.83	63.90	24	28	

Pressure bar	Nozzle	Radius m	Flow m³/h	Flow l/m	■ Precip mm/h	▲ Precip mm/h
4.5	● 4	12.5	1.00	16.69	13	15
	● 6	13.4	1.48	24.46	16	19
	● 8	14.6	1.97	32.81	18	21
	● 10	15.3	2.42	40.40	21	24
	● 12	16.5	2.95	49.13	22	25
	● 14	16.2	3.36	55.94	26	30
	● 16	17.1	3.73	62.22	26	30
	● 18	18.0	4.07	67.89	25	29
5.0	● 4	12.3	1.06	17.70	14	16
	● 6	13.1	1.56	25.74	18	21
	● 8	15.1	2.08	34.73	18	21
	● 10	15.4	2.57	42.78	22	25
	● 12	16.8	3.12	51.96	22	26
	● 14	16.2	3.54	59.06	27	31
	● 16	17.5	3.96	65.96	26	30
	● 18	18.0	4.30	71.74	27	31
5.5	● 4	11.9	1.11	18.52	16	18
	● 6	13.1	1.61	26.84	19	22
	● 8	15.5	2.20	36.65	18	21
	● 10	14.9	2.70	44.97	24	28
	● 12	16.8	3.27	54.43	23	27
	● 14	16.2	3.74	62.35	29	33
	● 16	18.0	4.17	69.53	26	30
	● 18	18.0	4.53	75.58	28	32
6.0	● 18	18.4	4.75	79.16	28	32
6.2	● 18	18.6	4.84	80.62	28	32

Precipitation rates based on half-circle operation

■ Square spacing based on 50% diameter of throw

▲ Triangular spacing based on 50% diameter of throw

Performance data collected in zero wind conditions

Performance data derived from tests that conform with ASABE Standards; ASABE S398.1.

See page 177 for complete ASABE Test Certification Statement.

8005 Series

Protect Your Turf with High Performance, Vandal and Abuse Resistant Rotors from 39' to 81'

Features

- Vandal resistance, brass reinforced turret for increased side impact durability
- Memory Arc® returns the rotor to its original arc setting
- Non-strippable drive mechanism prevents damage from vandals
- Easy, wet, dry arc adjustment with slotted screwdriver through top of rotor from 50° to 330° part-circle, 360° non-reversing full-circle. Full and part circle operation in one unit
- Left and right side trips adjustable for ease of installation without turning the case and loosening the pipe connection
- SAM Seal-A-Matic check valve
- 3-port, color-coded Rain Curtain nozzles for optimal long-range, mid-range, and close-in watering
- 5 year warranty

Options

- **Stainless steel (SS)** riser helps deter vandalism on public turf areas
- **Purple cover (NP)** for non-potable systems

Operating Specifications

- Radius: 39 to 81 feet (11.9 to 24.7 m)
- Precipitation rate: 0.48 to 1.23 inches per hour (12 to 31 mm/h)
- Pressure: 50 to 100 psi (3.5 to 6.9 bar)
- Flow: 3.8 to 36.3 gpm (0.86 to 8.24 m³/h; 14.4 to 137.4 l/m)
- 1" (26/34) NPT or BSP female threaded inlet
- SAM check device holds up to 10 feet (3.1 m) of head
- Nozzle outlet trajectory is 25°
- Rain Curtain™ Nozzles: 04 - black; 06 - light blue; 08 - dark green; 10 - gray; 12 - beige; 14 - light green; 16 - dark brown; 18 - dark blue; - 20 - red; 22 - yellow; 24 - orange; 26 - white

Note: Flow ranges of 7005 and 8005 are combined into 8005 rotor

Models

- 8005: 1" NPT female threaded inlet (plastic riser stem)
- 8005-NP: 1" NPT female threaded inlet (plastic riser stem with non-potable cover)
- 8005-SS: 1" NPT female threaded inlet (5" stainless steel covered riser stem)
- 8005-SS-NP: 1" NPT female threaded inlet (5" stainless steel covered riser stem with non-potable cover)
- Optional Sod Cup

Note: All models available with BSP threads

**** Note:** Pop-up height is measured from cover to the primary nozzle port. Overall body height is measured popped down





8005 Series

 0.48 to 1.23 in/hr
(12 to 31 mm/h)

 50 to 100 psi
(3.5 to 6.9 bar)

 3.8 to 36.3 gpm
(14.4 to 137.4 l/m)
(0.86 to 8.24 m³/h)

 5" (12.7 cm)

 10 1/8" (25.7 cm)

 1" (26/34) NPT
or BSP

How To Specify

8005 - SS - NP - 16

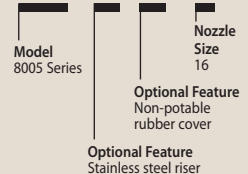

Note: For non-U.S. applications, it is necessary to specify NPT or BSP thread type.



8005 Nozzle Performance					
Pressure psi	Nozzle	Radius ft.	Flow gpm	■ Precip In/h	▲ Precip In/h
50	● 04	39	3.8	0.48	0.56
	● 06	45	5.6	0.53	0.62
	● 08	49	6.6	0.53	0.61
	● 10	53	9.3	0.64	0.74
	● 12	57	11.1	0.66	0.76
	● 14	59	12.6	0.70	0.81
	● 16	61	14.3	0.74	0.85
	● 18	63	16.1	0.78	0.90
	● 20	65	18.6	0.85	0.98
	● 22	65	20.7	0.94	1.09
	● 24	63	22.3	1.08	1.25
	○ 26	65	24.3	1.11	1.28
	60	● 04	39	3.8	0.48
● 06		45	6.1	0.58	0.67
● 08		49	8.4	0.67	0.78
● 10		53	10.1	0.69	0.80
● 12		59	12.0	0.66	0.77
● 14		61	14.3	0.74	0.85
● 16		65	15.9	0.72	0.84
● 18		65	17.8	0.81	0.94
● 20		67	20.1	0.86	1.00
● 22		71	23.2	0.89	1.02
● 24		69	24.7	1.00	1.15
○ 26		73	26.7	0.96	1.11
70		● 04	39	4.7	0.60
	● 06	45	6.7	0.64	0.74
	● 08	49	9.0	0.72	0.83
	● 10	55	11.1	0.71	0.82
	● 12	59	13.2	0.73	0.84
	● 14	63	15.3	0.74	0.86
	● 16	67	17.2	0.74	0.85
	● 18	67	19.3	0.83	0.96
	● 20	71	22.0	0.84	0.97
	● 22	73	25.2	0.91	1.05
	● 24	75	27.0	0.92	1.07
	○ 26	75	29.4	1.01	1.16
	80	● 04	39	5.0	0.63
● 06		45	7.1	0.68	0.78
● 08		49	9.8	0.79	0.91
● 10		55	11.8	0.75	0.87
● 12		61	14.2	0.73	0.85
● 14		63	16.4	0.80	0.92
● 16		67	18.6	0.80	0.92
● 18		69	20.9	0.85	0.98
● 20		71	23.9	0.91	1.05
● 22		75	27.3	0.93	1.08
● 24		77	29.2	0.95	1.10
○ 26		79	31.5	0.97	1.12

Pressure psi	Nozzle	Radius ft.	Flow gpm	■ Precip In/h	▲ Precip In/h
90	● 12	61	14.7	0.76	0.88
	● 14	65	17.9	0.82	0.94
	● 16	69	20.0	0.81	0.93
	● 18	71	22.2	0.85	0.98
	● 20	73	25.3	0.91	1.06
	● 22	75	29.1	1.00	1.15
	● 24	79	31.0	0.96	1.10
	○ 26	79	33.7	1.04	1.20
100	● 20	75	26.8	0.85	0.97
	● 22	77	30.7	1.00	1.15
	● 24	79	32.8	1.01	1.17
	○ 26	81	36.3	1.07	1.23

Precipitation rates based on half-circle operation

■ Square spacing based on 50% diameter of throw

▲ Triangular spacing based on 50% diameter of throw

Performance data collected in zero wind conditions

Performance data derived from tests that conform with ASABE Standards; ASABE S398.1.

See page 177 for complete ASABE Test Certification Statement.



8005 Cutaway



Sod Cup for 8005

8005 Nozzle Performance						METRIC	
Pressure bar	Nozzle	Radius m	Flow m ³ /h	Flow l/m	■ Precip mm/h	▲ Precip mm/h	
3.5	● 4	11.9	0.86	14.38	12	14	
	● 6	13.7	1.28	21.34	14	16	
	● 8	14.9	1.59	25.50	14	16	
	● 10	16.1	2.10	35.43	16	19	
	● 12	17.5	2.52	42.27	16	19	
	● 14	18.0	2.89	48.18	18	21	
	● 16	18.7	3.28	54.59	19	22	
	● 18	19.2	3.69	61.43	20	23	
	● 20	19.9	4.25	70.83	21	25	
	● 22	20.0	5.08	79.07	25	29	
	● 24	19.3	5.11	85.10	27	32	
	○ 26	20.0	5.57	92.67	28	32	
4.0	● 4	11.9	0.93	14.38	13	15	
	● 6	13.7	1.37	22.71	15	17	
	● 8	14.9	1.75	30.44	16	18	
	● 10	16.3	2.30	37.63	17	20	
	● 12	17.7	2.70	44.74	17	20	
	● 14	18.5	3.17	52.85	19	21	
	● 16	19.6	3.54	58.98	18	21	
	● 18	19.7	3.97	66.10	20	24	
	● 20	20.3	4.50	74.95	22	25	
	● 22	21.3	5.23	85.94	23	27	
	● 24	20.7	5.50	91.69	26	30	
	○ 26	21.8	6.01	99.26	25	29	
4.5	● 4	11.9	1.00	16.18	14	16	
	● 6	13.7	1.45	24.28	15	18	
	● 8	14.9	1.92	32.99	17	20	
	● 10	16.5	2.40	40.22	18	20	
	● 12	18.0	2.87	47.81	18	20	
	● 14	18.9	3.37	56.12	19	22	
	● 16	20.1	3.77	62.77	19	22	
	● 18	20.1	4.22	70.36	21	24	
	● 20	21.1	4.79	79.87	22	25	
	● 22	22.0	5.51	91.80	23	26	
	● 24	22.0	5.88	98.08	24	28	
	○ 26	22.6	6.42	106.44	25	29	
5.0	● 4	11.9	1.06	18.08	15	17	
	● 6	13.7	1.54	25.74	16	19	
	● 8	14.9	2.09	34.83	19	22	
	● 10	16.7	2.50	42.68	18	21	
	● 12	18.3	3.05	50.92	18	21	
	● 14	19.2	3.54	58.96	19	22	
	● 16	20.4	3.99	66.44	19	22	
	● 18	20.6	4.47	74.58	21	24	
	● 20	21.6	5.11	85.08	22	25	
	● 22	22.4	5.84	97.39	23	27	
	● 24	23.0	6.26	104.29	24	27	
	○ 26	23.2	6.80	113.28	25	29	

Pressure bar	Nozzle	Radius m	Flow m ³ /h	Flow l/m	■ Precip mm/h	▲ Precip mm/h
5.5	● 4	11.9	1.13	18.90	16	18
	● 6	13.7	1.62	26.84	17	20
	● 8	14.9	2.25	37.02	20	23
	● 10	16.8	2.70	44.60	19	22
	● 12	18.5	3.23	53.66	19	22
	● 14	19.2	3.72	61.98	20	23
	● 16	20.4	4.22	70.28	20	23
	● 18	21.0	4.74	78.97	21	25
	● 20	21.6	5.42	90.30	23	27
	● 22	22.8	6.19	103.15	24	28
	● 24	23.5	6.62	110.33	24	28
	○ 26	24.1	7.14	119.05	25	28
6.0	● 12	18.6	3.30	55.07	19	22
	● 14	19.6	3.96	66.06	21	24
	● 16	20.9	4.45	74.12	20	24
	● 18	21.5	4.95	82.56	21	25
	● 20	22.1	5.65	94.18	23	27
	● 22	22.9	6.71	108.12	26	30
6.2	● 24	23.9	6.92	115.31	24	28
	○ 26	24.1	7.50	125.08	26	30
	● 14	19.8	4.06	67.75	21	24
	● 16	21.0	4.54	75.70	21	24
6.5	● 18	21.7	5.04	84.02	21	25
	● 20	22.5	5.89	98.19	23	27
	● 22	23.4	6.84	112.73	25	29
	● 24	24.1	7.22	120.25	25	29
6.9	○ 26	24.3	7.91	131.76	27	31
	● 20	22.9	6.09	101.43	23	27
	● 22	23.5	6.97	116.19	25	29
6.9	● 24	24.1	7.45	124.14	26	30
	○ 26	24.7	8.24	137.39	27	31

Precipitation rates based on half-circle operation

■ Square spacing based on 50% diameter of throw

▲ Triangular spacing based on 50% diameter of throw

Performance data collected in zero wind conditions

Performance data derived from tests that conform with ASABE Standards; ASABE S398.1. See page 177 for complete ASABE Test Certification Statement.



8005 Rain Curtain™ Nozzles

Optional High-flow Nozzles for 8005 Series Rotors

Rain Curtain™ Nozzle Cross Reference Guide Hunter® vs. Rain Bird

Rain Curtain™ Nozzle Cross Reference Guide Toro® vs. Rain Bird

Hunter vs. Rain Bird – 3/4" Rotors		
If replacing:	Use Rain Bird Nozzle	
	By Flow	By Radius
PGP	5000 Series	5000 Series
1	-	-
2	-	-
3	-	-
4	1.5	1.5
5	2.0	2.0
6	2.5	2.5
7	3.0	3.0
8	4.0	4.0
9	5.0	5.0
10	8.0	6.0
11	-	8.0
12	-	8.0

Toro vs. Rain Bird – 3/4" Rotors		
If replacing:	Use Rain Bird Nozzle	
	By Flow	By Radius
Super 800	5000 Series	5000 Series
0.5	-	-
0.75	-	-
1.0	1.5	1.5
2.0	2.5	2.0
2.5	3.0	2.5
3.0	4.0	2.5
4.0	5.0	3.0
6.0	6.0	4.0
8.0	8.0	5.0

Rotors

Hunter vs. Rain Bird – 3/4" Rotors				
If replacing:	Use Rain Bird Nozzle			
	By Flow		By Radius	
I-20	5000 Series	5500	5000 Series	5500
0.5 SR	-	-	-	18S
1.0 SR	-	-	-	18S
2.0 SR	-	18S	-	18S
0.75 SR	-	-	-	22S
1.5 SR	-	22S	-	22S
3.0 SR	-	26S	-	22S
1.0	1.5	-	1.5	30S
1.5	1.5	2	1.5	30S
2.0	2.0	2	2.0	2
3.0	2.5	3	2.5	2
3.5	3.0	4	3.0	3
4.0	4.0	5	4.0	3
6.0	5.0	6	5.0	4
8.0	6.0	8	6.0	8

Toro vs. Rain Bird – 3/4" Rotors				
If replacing:	Use Rain Bird Nozzle			
	By Flow		By Radius	
TR50	5000 Series	5505	5000 Series	5505
1.0	-	-	-	-
1.5	1.5	2	1.5	2
2.0	2.0	2	2.0	3
3.0	3.0	3	3.0	3
4.5	4.0	5	4.0	3
6.0	5.0	6	4.0	4
7.5	6.0	8	4.0	4
9.0	8.0	10	5.0	4

Hunter vs. Rain Bird – 1" Rotors				
If replacing:	Use Rain Bird Nozzle			
	By Flow		By Radius	
I-25	6504	8005	6504	8005
4	4	4	4	4
5	6	6	6	6
7	8	8	6	8
8	10	10	8	8
10	12	12	10	10
13	12	12	12	12
15	14	14	14	12
18	16	16	16	14
20	18	18	18	14
23	-	22	-	16
25	-	24	-	20
28	-	26	-	22
I-40	6504	8005	6504	8005
40	8	8	6	8
41	12	12	10	10
42	12	12	10	12
43	16	16	14	14
44	18	20	18	16
45	-	22	-	20
I-35	6504	8005	6504	8005
9	8	8	8	8
12	12	12	10	10
15	14	14	12	12
18	16	16	14	14
21	18	18	14	14
24	-	22	-	16
27	-	24	-	16
30	-	26	-	20

Toro vs. Rain Bird – 1" Rotors				
If replacing:	Use Rain Bird Nozzle			
	By Flow		By Radius	
Toro 2001	6504	8005	6504	8005
9	10	10	10	10
12	12	12	12	12
15	16	16	14	14
18	18	20	18	16
24	-	22	-	20
TR70	6504	8005	6504	8005
7	8	8	-	6
9	8	8	8	8
12	12	12	10	10
16	16	16	14	12
20	-	20	14	14
24	-	20	16	14
27	-	20	18	16
Toro 640	6504	8005	6504	8005
40	8	8	8	10
41	10	12	10	10
42	14	14	12	12
43	16	16	14	14
44	18	20	16	14

2045A Maxi-Paw™ and 2045-PJ Maxi-Bird™

Dirty Water Applications - Spacing Up to 45 Feet (13.7 m)

Features

- Proven impact drive with straight-through flow for superior performance in dirty water
- Five standard trajectory and two low angle (LA) color-coded nozzles for matched precipitation and in a wide range of applications
- 360° full-circle OR arc adjustable from 20° to 340°
- Side and combination ½" or ¾" bottom inlet for design flexibility (Maxi-Paw)
- 3 year warranty

Operating Specifications

- Precipitation rate: 0.28 to 1.21 inches per hour (7 to 31 mm/h)
- Spacing: 22 to 45 feet (6.7 to 13.7 m)
- Flow rate: 1.5 to 8.4 gpm (0.34 to 1.91 m³/h; 0.9 to 0.53 l/s)
- Radius: 22 to 45 feet (6.7 to 13.7 m); 18 feet (5.4 m) with Radius Reduction Screw
- Pressure: 25 to 60 psi (1.7 to 4.1 bar)
- Combination ½" or ¾" female bottom inlet (Maxi-Paw)
- ½" FPT side inlet (Maxi-Paw)
- ½" (15/21) Riser-Mounted (Maxi-Bird)

Models

- 2045A Maxi-Paw
- 2045A Maxi-Paw-SAM
- 2045A Maxi-Paw-SAM-NP
- 42064: Maxi-Paw Wrench - for removing internal assembly from case
- 2045-PJ Maxi-Bird



2045A Maxi-Paw



2045-PJ Maxi-Bird



42064

How To Specify

2045A- SAM-10- LA

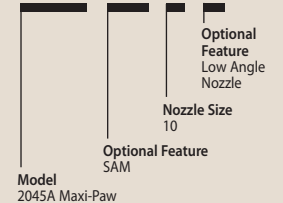

Rotors

Maxi-Paw and Maxi-Bird Nozzle Performance					
Pressure psi	Nozzle	Radius ft.	Flow gpm	■ Precip In/h	▲ Precip In/h
25	● 06	-	-	-	-
	● 07 LA	22	1.5	0.60	0.69
	● 07	32	2.2	0.41	0.48
	● 08	35	2.8	0.44	0.51
	● 10 LA	25	3.4	1.05	1.21
	● 10	38	4.2	0.56	0.65
35	● 12	39	5.5	0.70	0.80
	● 06	37	2.0	0.28	0.32
	● 07 LA	23	1.9	0.69	0.80
	● 07	37	2.7	0.38	0.44
	● 08	38	3.3	0.44	0.51
	● 10 LA	29	4.0	0.92	1.06
45	● 10	41	4.8	0.55	0.64
	● 12	42	6.3	0.69	0.79
	● 06	38	2.3	0.31	0.35
	● 07 LA	25	2.1	0.65	0.75
	● 07	39	3.0	0.38	0.44
	● 08	40	3.7	0.45	0.51
55	● 10 LA	31	4.5	0.90	1.04
	● 10	42	5.4	0.59	0.68
	● 12	44	7.1	0.71	0.82
	● 06	38	2.5	0.33	0.39
	● 07 LA	25	2.3	0.71	0.82
	● 07	41	3.3	0.38	0.44
60	● 08	41	4.1	0.47	0.54
	● 10 LA	32	5.0	0.94	1.09
	● 10	43	6.0	0.62	0.72
	● 12	45	7.9	0.75	0.87
	● 06	38	2.6	0.35	0.40
	● 07 LA	25	2.4	0.74	0.85
	● 07	41	3.5	0.40	0.46
	● 08	42	4.2	0.46	0.53
	● 10 LA	32	5.4	1.02	1.17
	● 10	44	6.4	0.64	0.74
	● 12	45	8.4	0.80	0.92

Maxi-Paw and Maxi-Bird Nozzle Performance METRIC						
Pressure bar	Nozzle	Radius m	Flow m ³ /h	Flow l/m	■ Precip mm/h	▲ Precip mm/h
2.0	● 6	-	-	-	-	-
	● 07 LA	6.8	0.38	6.0	16	19
	● 7	10.4	0.55	9.0	10	12
	● 8	11.0	0.68	11.4	11	13
	● 10 LA	8.1	0.83	13.8	25	29
	● 10	11.9	1.01	16.8	14	16
2.5	● 12	12.3	1.32	22.2	18	20
	● 6	11.3	0.46	7.8	7	8
	● 07 LA	7.1	0.44	7.2	17	20
	● 7	11.4	0.62	10.2	10	11
	● 8	11.7	0.76	12.6	11	13
	● 10 LA	8.9	0.92	15.6	23	27
3.0	● 10	12.5	1.11	18.6	14	16
	● 12	12.9	1.45	24.0	18	20
	● 6	11.5	0.51	8.4	8	9
	● 07 LA	7.5	0.47	7.8	17	19
	● 7	11.8	0.67	11.4	10	11
	● 8	12.1	0.83	13.8	11	13
3.5	● 10 LA	9.4	1.01	16.8	23	27
	● 10	12.8	1.21	20.4	15	17
	● 12	13.3	1.59	26.4	18	21
	● 6	11.6	0.55	9.0	8	9
	● 07 LA	7.6	0.50	8.4	17	20
	● 7	12.2	0.72	12.0	10	11
4.0	● 8	12.4	0.89	15.0	12	13
	● 10 LA	9.6	1.09	18.0	23	27
	● 10	13.0	1.30	21.6	15	18
	● 12	13.6	1.72	28.8	19	21
	● 6	11.6	0.58	9.6	9	10
	● 07 LA	7.6	0.54	9.0	18	21
	● 7	12.5	0.78	13.2	10	11
	● 8	12.7	0.94	15.6	12	14
	● 10 LA	9.8	1.19	19.8	25	29
	● 10	13.3	1.42	23.4	16	19
	● 12	13.7	1.86	31.2	20	23

LA = Low Angle

Precipitation rates based on half-circle operation

■ Square spacing based on 50% diameter of throw

▲ Triangular spacing based on 50% diameter of throw

Performance data collected in zero wind conditions

Performance data derived from tests that conform with ASABE Standards; ASABE S398.1.

See page 177 for complete ASABE Test Certification Statement.



2045A Maxi-Paw and 2045-PJ
Standard Angle Nozzles



2045A Maxi-Paw and 2045-PJ
Low Angle Nozzles

TSJ/TSJ-PRS Series

Swing Joints Connect ¾" (1.9 cm) and 1" (2.5 cm) Rotors or Quick Coupler Valves to Lateral Pipes

Features

- Preassembled units save the contractor time and reduce installation costs
- Excellent structural integrity from the swept elbow design reduces the costs associated with fatigue related failures
- Double O Ring provides extra protection against leaks and keeps threads clean of debris making hand tightening easy
- The TSJ-PRS combines the great flow characteristics of the Rain Bird turf swing joint with an inline pressure regulating outlet elbow for controlling and maintaining constant pressure right at the rotor inlet



Operating Specifications

- Pressure rating: 315 psi at 73° F (21.7 bar at 22.8° C) (per ASTM D3139)
- ¾" joint pressure loss: 0.3 psi at 6 gpm (0.02 bar at 0.4 l/s)
- 1" joint pressure loss: 1.5 psi at 18 gpm; 2.5 psi at 23 gpm (0.1 bar at 1,1 l/s; 0.2 bar at 1.5 l/s)
- TSJ-PRS maximum flow: 22 gpm (1.41 l/s)

TSJ-PRS Application Information

- The TSJ-PRS is not recommended for use in systems where the pressure in the lateral lines is equal to or less than the nominal regulation pressure, as the increased pressure drop may adversely affect the performance of such systems
- To reduce the effects of water hammer, Rain Bird recommends flow rates in the supply line not exceed 5 ft/sec (1.5 m/s). The TSJ-PRS is not intended to function as a water hammer prevention device
- There are no user-serviceable parts inside. The internal spring is under compression. Do not open the PRS unit under any circumstances

Models

- TSJ-12075: 12" (30.5 cm) long, ¾" (20/27) M x M NPT swing joint
- TSJ-12: 12" (30.5 cm) long, 1" (26/34) M x M NPT swing joint
- TSJ-100-PRS: 1" swing joint with 70 psi pressure regulator, 12" (30.5 cm) long, 1" (26/34) M x M NPT inlet and outlet

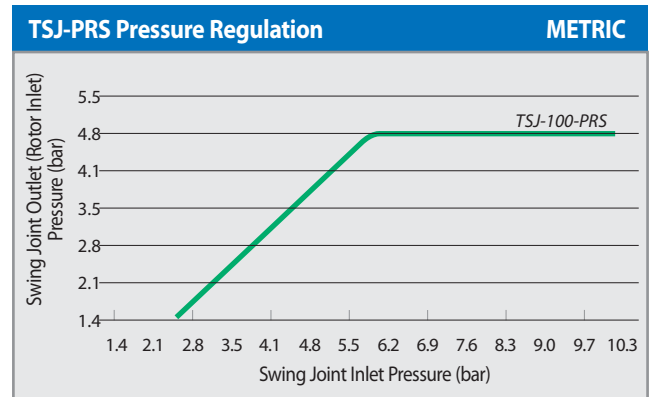
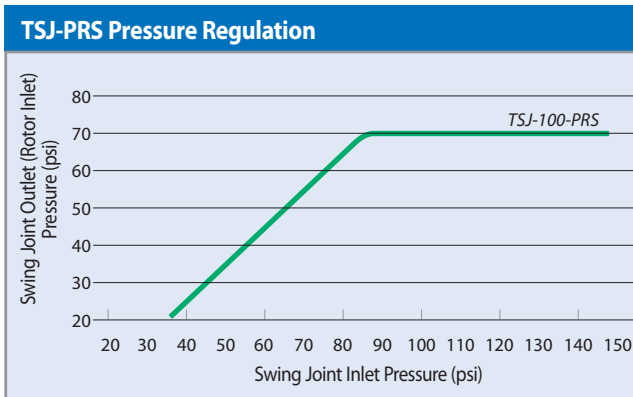

Swing Joint Specifications

Model Number	Length		Inlet		Outlet		Thread	Pressure Regulation	
	US	METRIC	US	METRIC	US	METRIC		US	METRIC
TSJ-12075	12"	30.5 cm	¾" M	20/27 M	¾" M	20/27 M	NPT	n/a	n/a
TSJ-12	12"	30.5 cm	1" M	26/34 M	1" M	26/34 M	NPT	n/a	n/a
TSJ-12-150	12"	30.5 cm	1" M	26/34 M	1" M	26/34 M	NPT	n/a	n/a
TSJ-18	18"	45.7 cm	1" M	26/34 M	1" M	26/34 M	NPT	n/a	n/a
TSJ-075-PRS	12"	30.5 cm	¾" M	20/27 M	¾" M	20/27 M	NPT	70 psi	70 psi
TSJ-100-PRS	12"	30.5 cm	1" M	26/34 M	1" M	26/34 M	NPT	70 psi	70 psi

Valves

Introduction

Spray/Bodies

Spray Nozzles

Rotors

Valves

Controllers

Central Controls

Landscape Drip

Pumps

Drainage Products

Resources



The Toughest, Most Reliable Valves In their Class

Relentless research, testing and retesting have led to a product you can stand behind. The Rain Bird® PGA valve is the preferred valve for high-end residential and light commercial jobs.

Major Products

Primary Applications	DV	DVF	ASVF	HV	HVF	PGA	PEB	PESB/PESB-R	EFB-CP	BPE	BPES	QC
Manual Bleed	I/E	I/E	I/E	I/E	I/E	I	I/E	I/E	I/E	E	E	
Flow Control		●	●		●	●	●	●	●	●	●	
Bottom Inlet	DV-A		●			●				●	●	●
Low Flow	●	●	●	●	●		●	●	●			
PRS-Dial Compatible						●	●	●	●	●	●	
Dirty Water								●	●		●	
Non-Potable Water						●	●	●	●	●	●	●
Sites Requiring Brass									●	●	●	●
Sites Requiring Plastic	●	●	●	●	●	●	●	●				
Decoder System Compatible						●	●	●	●	●	●	

• DV/DVF available in globe, angle, slip x slip, and male x barb configurations. • Flows below 3 gpm (0.68 m³/h; 0.19 l/s) install 200 mesh filter upstream. • I/E = Internal/External
 • The PESB-R and EFB-CP are specifically designed with chlorine-resistant components for reclaimed water applications.



Water Saving Tips

- The PRS-Dial is an excellent means of regulating outlet pressure at the valve regardless of incoming pressure fluctuations. It helps ensure optimal pressure performance at the head.
- Rain Bird valves provide excellent filtration characteristics for maximum reliability in a wide range of environments.
- PESB-R and EFB-CP reclaimed valves provide reliable operation in all water conditions. Valve diaphragms are composed of EPDM, a rubber material which is chlorine and chemical resistant.

DV / DVF Series

Diaphragm Valve – The Industry Leader for Over 20 Years

Features

- Double-filtered (diaphragm and solenoid) pilot-flow design for maximum reliability and grit resistance
- Buna-N, balanced pressure diaphragm with self-cleaning 90 mesh (200 micron) pilot water filter and captive spring
- Energy-efficient, low-power encapsulated solenoid with captured plunger and 90-mesh (200 micron) solenoid filter
- Unique, easy-to-turn patented pressure assisted flow control mechanism (DVF models only)
- External bleed to manually flush system of dirt and debris during installation and system start-up
- Internal bleed for spray-free manual operation
- Accepts Rain Bird TBOS latching solenoid for use with most battery-operated controllers
- Operates in low-flow and Xerigation® applications when a 200 mesh filter is installed upstream
- Not recommended for use with two-wire control systems

Specifications

- Pressure: 15 to 150 psi (1,0 to 10,4 bar)
- 075-DV Non-Flow Control Model: 0.2 to 22 GPM (0,05 to 5,0 m³/h; 0,01 to 1,39 l/s). For flows below 3 GPM (0,68 m³/h; 0,19 l/s) or any Xerigation® application, use a 200 mesh filter installed upstream
- 100-DV Non-Flow Control Model: 0.2 to 40 gpm (0,05 to 9,085 m³/h; 0,01 to 2,52 l/s). For flows below 3 gpm (0,68 m³/h; 0,19 l/s) or any Xerigation® application, use a 200 mesh filter installed upstream
- 100-DVF Flow Control Model: 0.2 to 40 gpm (0,05 to 9,085 m³/h; 0,01 to 2,52 l/s); For flows below 3 gpm (0,68 m³/h; 0,19 l/s) or any Xerigation application, use a 200 mesh filter installed upstream
- Water Temperature: Up to 110° F (43° C)
- Ambient air temperature: Up to 125° F (52° C)
- 24 VAC 50/60 Hz (cycles per second) solenoid power requirement: 0.450A inrush current; 0.250A holding current
- Solenoid coil resistance: 38 Ohms



075-DV



100-DVF-MB



100-DV-A



100-DVF

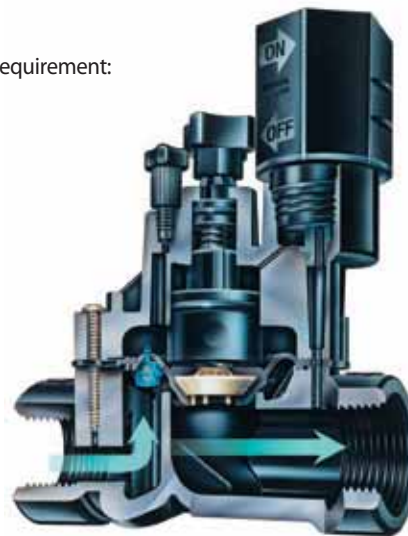

DVF Cutaway

How To Specify

100 - DV - MB

Optional Configuration:
MB: Male x Barb
A: Angle
SS: Slip x Slip

Model

DV: Remote Control Valve
DVF: Remote Control Valve with Flow Control

Size

075: 3/4" (20/27);
100: 1" (26/34)

This specifies a 100-DV valve, 1" (26/34) male x barb with flow control. Note: For non-U.S. applications it is necessary to specify NPT or BSP thread type (1" only).

DV / DVF Series (cont.)

Dimensions

DV Valves

- Height: 4½" (11.4 cm)
- Height (Angle): 5½" (14 cm)
- Length: 4¾" (11.1 cm)
- Length (Angle): 3¾" (9.5 cm)
- Length (MB): 5¾" (14.6 cm)
- Width: 3½" (8.4 cm)

DVF Valves

- Height: 5¾" (14.2 cm)
- Length: 4¾" (11.1 cm)
- Length (MB): 5¾" (14.6 cm)
- Width: 3½" (8.4 cm)

Models

- 075-DV: ¾" (20/27) NPT
- 100-DV: 1" (26/34) NPT female x female*
- 100-DV-SS: 1" (26/34) slip x slip
- 100-DV-A: 1" (26/34) NPT female x female
- 100-DV-MB: 1" (26/34) male x barb
- 100-DVF: 1" (26/34) NPT female x female*
- 100-DVF-SS: 1" (26/34) slip x slip
- 100-DVF-MB: 1" (26/34) male x barb

* Available with BSP threads

Recommendations

1. Rain Bird recommends flow rates that result in discharge velocities in the supply line not to exceed 7.5 ft/sec (2.3 m/s) in order to reduce the effects of water hammer.
2. Rain Bird residential valves cannot be used with PRS pressure regulating modules.
3. Not recommended for use with two-wire systems.

DV and DVF Valve Pressure Loss (psi)		
Flow gpm	075-DV ¾" psi	100-DV/100-DVF 1" psi
1	3.2	3.3
3	3.9	3.6
5	4.2	3.8
10	5.0	3.8
20	7.7	5.1
30	-	6.4
40	-	8.6

DV and DVF Valve Pressure Loss (bar)			METRIC
Flow m³/h	l/m	075-DV ¾" bar	100-DV/100-DVF 1" bar
0.23	4	0.22	0.23
0.60	10	0.26	0.24
1.20	20	0.29	0.26
3.60	60	0.45	0.32
4.50	75	0.53	0.35
6.00	100	-	0.41
9.00	150	-	0.59

100-DV Angle, MxB Valve Pressure Loss (psi)		
Flow gpm	Angle 1" psi	Male x barb 1" psi
1	2.8	2.5
3	3.0	2.9
5	3.2	3.0
10	3.9	3.1
20	4.3	4.3
30	5.4	7.4
40	8.2	12.7

100-DV Angle, MxB Valve Pressure Loss (bar)			METRIC
Flow m³/h	l/m	Angle 1" bar	Male x barb 1" bar
0.23	4	0.19	0.17
0.60	10	0.20	0.19
1.20	20	0.22	0.21
3.60	60	0.28	0.26
4.50	75	0.30	0.30
6.00	100	0.35	0.44
9.00	150	0.56	0.86

Note: DV/DVF Male x barb not recommended for flows exceeding 30 gpm (6.81 m³/h, 113.56 l/m)

ASVF Series

Anti-siphon Valve with Flow Control – The Industry Leader for Over 20 Years

Features

- Combination of the reliable DVF Angle valve and atmospheric backflow preventer in one unit
- Incorporates all features of DV/DVF Series valves
- I.A.P.M.O. and A.S.S.E listing approved
- City of Los Angeles listing approved
- Canadian Standards Association approved
- Not recommended for use with two-wire control systems

Specifications

- Pressure: 15 to 150 psi (1,0 to 10,4 bar)
- 075-ASVF Flow: 0.2 to 22 GPM (0,05 to 5,0 m³/h; 0,01 to 1,39 l/s). For flows below 3 GPM (0,68 m³/h; 0,19 l/s) or any Xerigation® products application, use a 200 mesh filter installed upstream
- 100-ASVF Flow: 0.2 to 40 GPM (0,05 to 9,085 m³/h; 0,01 to 2,52 l/s). For flows below 3 GPM (0,68 m³/h; 0,19 l/s) or any Xerigation® products application, use a 200 mesh filter installed upstream
- Water temperature: Up to 110° F (43° C)
- Ambient air temperature: Up to 125° F (52° C)
- 24 VAC 50/60 Hz (cycles per second) solenoid power requirement: 0.450A inrush current; 0.250A holding current
- Solenoid coil resistance: 38 Ohms

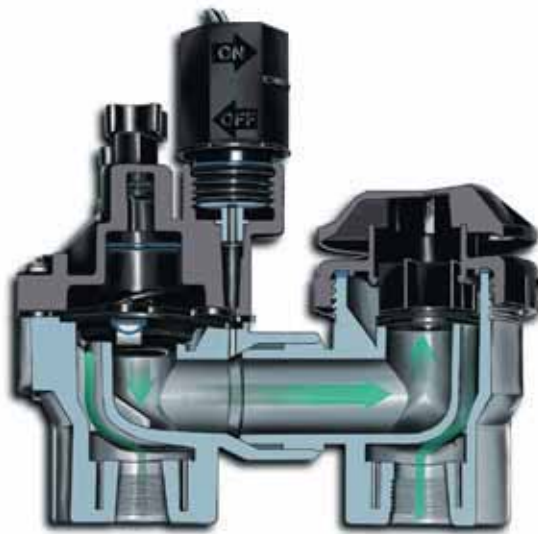

ASVF Cutaway

Installation Notes

- Anti-siphon valve must be installed upright
- Anti-siphon unit must be installed at least 6" (15,2 cm) above the highest point of water in the pipe and sprinklers it serves
- No valve can be located downstream of the anti-siphon valve
- Anti-siphon valves must not be subjected to operating pressure for more than twelve (12) hours in any twenty-four (24) hour period
- Uniform Plumbing Code Sec. 1003 (2) 602.2 Consult local codes

Dimensions

- Height: 6¼" (15.8 cm)
- Length: 6¼" (15.5 cm)
- Width: 3½" (8.1 cm)

Models

- 075-ASVF: ¾" (20/27)
- 100-ASVF: 1" (26/34)

Models available in NPT threads only

Recommendations

1. Rain Bird recommends flow rates that result in discharge velocities in the supply line not to exceed 7.5 ft/sec (2.3 m/s) in order to reduce the effects of water hammer.
2. Rain Bird residential valves cannot be used with PRS pressure regulating modules.
3. Not recommended for use with two-wire systems.



100-ASVF

ASVF Valve Pressure Loss (psi)

Flow gpm	075-ASVF ¾" psi	100-ASVF 1" psi
1	2.8	2.9
3	3.4	3.1
5	3.8	3.3
10	4.6	3.9
20	6.5	5.0
30	-	7.8
40	-	13.4

ASVF Valve Pressure Loss (bar)

		METRIC	
Flow m ³ /h	l/m	075-ASVF ¾" bar	100-ASVF 1" bar
0.23	3.8	0.19	0.20
0.6	10	0.23	0.21
1.2	20	0.26	0.23
3.6	60	0.39	0.31
4.5	75	0.45	0.34
6.0	100	-	0.47
9.0	150	-	0.91

* Rain Bird recommends flow rates in the supply line not to exceed 7.5 ft/sec (2.3 m/s) in order to reduce the effects of water hammer

HV Series

High Value Valve. High Performance. Big Savings.

Features

- Patented, eccentric, balanced pressure, Buna-N diaphragm with self-cleaning 90-mesh (200 micron) pilot water filter and captured stainless steel spring – Eccentric design provides smoother closing, less water hammer
- Only four durable, captured multi-drive bonnet screws that come out with half the number of turns for fast and easy servicing – at least twice as fast as the competition
- Glass-filled polypropylene body for strength (slip by slip model bodies are PVC)
- All popular model configurations available
- Compact design, 2.54" spin radius for tight installations
- Reverse flow, normally closed design
- External bleed to manually flush system of dirt and debris during installation and system start-up
- Internal bleed for spray-free manual operation
- Operates in low-flow and Xerigation® applications when a 200 mesh filter is installed upstream

Specifications

- Pressure: 15 to 150 PSI (1,0 to 10,3 bar)
- Flow: 0.2 to 30 GPM (0,05 to 6,82 m³/h; 0,01 to 1,89 l/s); for flows below 3 GPM (0,68 m³/h; 0,19 l/s) or any Xerigation® application, use a 200 mesh filter installed upstream
- Operating Temperatures: Water temperature up to 110° F (43° C); ambient temperature up to 125° F (52° C)
- 24 VAC 50/60 Hz (cycles/sec.) solenoid
- Inrush current: 0.450A at 60 Hz
- Holding current: 0.250A at 60 Hz
- Solenoid Coil resistance: 70-85 Ohms (40° F - 110° F)



HV Valve Pressure Loss (psi)

Flow (gpm)	1" HV (psi)	1" HV-MB (psi)
1	1.57	1.73
3	2.07	2.03
5	2.38	2.25
10	3.33	2.80
20	4.59	4.45
30	6.14	7.85
40	8.23	13.68

HV Valve Pressure Loss (psi)

HV Valve Pressure Loss (psi)		METRIC	
Flow (m ³ /h)	Flow (l/s)	1" HV (bar)	1" HV-MB (bar)
0.25	0.06	0.11	0.12
0.75	0.21	0.14	0.14
1.00	0.28	0.16	0.16
2.00	0.56	0.23	0.19
5.00	1.39	0.32	0.31
7.50	2.08	0.42	0.54
9.10	2.52	0.57	0.94

* Rain Bird recommends flow rates in the supply line not to exceed 7.5 ft/sec (2.3 m/s) in order to reduce the effects of water hammer

Dimensions

- Height: 4.62" (11.7 cm)
- Height (MB): 4.50" (11.4 cm)
- Length: 4.4" (11.2 cm)
- Length (MB): 5.68" (14.4 cm)
- Width: 3.1" (7.9 cm)

Models

- 100-HV-NPT: 1" (26/34) NPT female x female*
- 100-HV-SS: 1" (26/34) slip x slip
- 100 HV-MB: 1" (26/34) male x barb
- 100 HVF: 1" (26/34) NPT female x female*
- 100 HVF-SS: 1" (26/34) slip x slip

*Available with BSP threads

Recommendations

1. Rain Bird recommends flow rates that result in discharge velocities in the supply line not to exceed 7.5 ft/sec (2.3 m/s) in order to reduce the effects of water hammer.
2. Rain Bird residential valves cannot be used with PRS pressure regulating modules.
3. Not recommended for use with two-wire systems.

How To Specify

100 - HV - SS

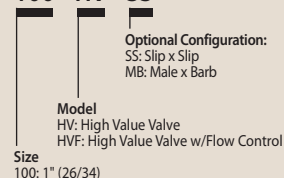

Note: For non-U.S. applications it is necessary to specify NPT or BSP thread type (1" only)

PGA Series

Plastic Globe and Angle Valves. The Toughest, Most Reliable Valves In their Class

Features

- Water-tight seal between the body and bonnet for maximum confidence, even in the most extreme conditions
- Robust construction and electrical design for quiet performance you can count on
- Filtered pilot flow to resist debris and clogging
- Slow closing to prevent water hammer and subsequent system damage
- Normally closed, forward flow design Accepts latching solenoid for use with Rain Bird battery-operated controllers
- Multi-drive screws (Phillips, flathead, hexagonal) for easy maintenance*
- Manual internal bleed operates the valve without allowing water into the valve box. This allows the pressure regulator to be adjusted without turning the valve on at the controller
- One-piece solenoid design with captured plunger and spring for easy servicing. Prevents loss of parts during field service
- Three-year trade warranty
- Accommodates optional, field-installed PRS-D pressure regulating dial to ensure optimum sprinkler performance
- Accepts latching solenoid for use with Rain Bird battery-operated controllers
- Optional purple flow control handle for non-potable water applications PGA-NP-HAN1 (1" and 1 1/2"); PGA-NP-HAN2 (2")



Extreme Durability

The PGA valve maintains a strong, worry-free seal between the body and bonnet, no matter the conditions. PGA valves were exposed to extreme temperature swings and intense pressures. The result—zero leaks.*



Pressure-Resistant Seal

The PGA valve's body-to-bonnet seal is built to overcome the intense water pressure typical of many commercial sites. Faced with repeated pressure surges well into the triple digits, our valves outlasted the nearest competitor more than 2 1/2 times to 1.*

* Based on 2013 testing conducted at Rain Bird's Product Research Facility in Tucson, AZ.

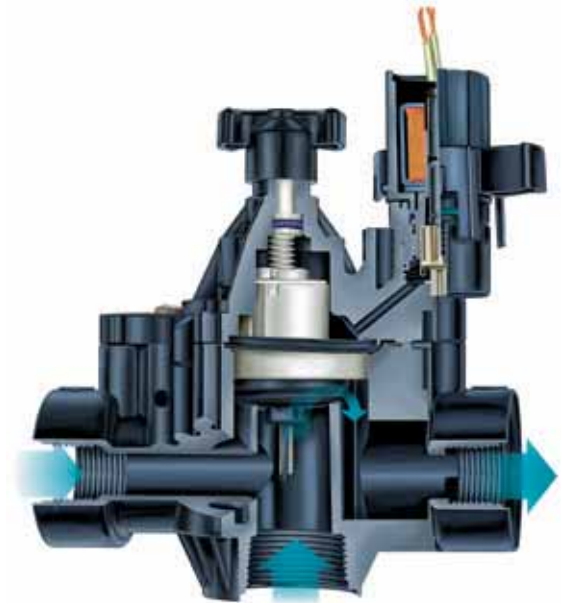

PGA Cutaway



150-PGA

How To Specify

100 - PGA - PRS-D

Model PGA	Optional Feature PRS-Dial: pressure regulating module (must be ordered separately)
Size 100: 1" (26/34) 150: 1 1/2" (40/49) 200: 2" (50/60)	

Note: Valve and PRS-Dial module must be ordered separately. For non-U.S. applications, it is necessary to specify NPT or BSP thread type.

PGA Series (cont.)

Specifications

- Pressure: 15 to 150 psi (1.04 to 10.4 bar)
- Flow without PRS-D option: 2 to 150 gpm (0.45 to 34.05 m³/h; 7.8 to 568 l/m)
- Flow with PRS-D option: 5 to 150 gpm (1.14 to 34.05 m³/h; 19.2 to 568 l/m)
- Water temperature: Up to 110° F (43° C) - refer to chart
- Ambient temperature: Up to 125° F (52° C)
- 24VAC 50/60Hz (cycles/sec) solenoid power requirement
- Inrush current: 0.41A (9.9VA) at 60Hz
- Holding current: 0.14A (3.43VA) at 60Hz
- Solenoid coil resistance: 30-39 Ohms, nominal

Dimensions

Model	Height	Length	Width
• 100-PGA	7 ¼" (18.4 cm)	5 ½" (14.0 cm)	3 ¼" (8.3 cm)
• 150-PGA	8" (20.3 cm)	6 ¾" (17.2 cm)	3 ½" (8.9 cm)
• 200-PGA:	10" (25.4 cm)	7 ¾" (19.7 cm)	5" (12.7 cm)

Note: PRS-Dial adds 2" (5.1 cm) to valve height

Models

- 100-PGA: 1" (26/34)
- 150-PGA: 1 ½" (40/49)
- 200-PGA: 2" (50/60)

BSP threads available; specify when ordering

Recommendations

1. Rain Bird recommends flow rates in the supply line not to exceed 7.5 ft/sec (2.29 m/s) in order to reduce the effects of water hammer
2. For flows below 5 gpm (1.14 m³/h; 19.2 l/m), Rain Bird recommends use of upstream filtration to prevent debris from collecting below the diaphragm
3. For flows below 10 gpm (2.27 m³/h; 37.8 l/m) Rain Bird recommends the flow control stem be turned down two full turns from the fully open position

PGA Series Valve Pressure Loss (psi)

Flow gpm	100-PGA Globe 1"	100-PGA Angle 1"	150-PGA Globe 1½"	150-PGA Angle 1½"	200-PGA Globe 2"	200-PGA Angle 2"
1	5.1	4.3	-	-	-	-
5	5.5	5.0	-	-	-	-
10	5.9	5.5	-	-	-	-
20	6.0	5.6	-	-	-	-
30	6.4	5.5	1.9	1.3	-	-
40	7.0	7.5	3.2	2.0	1.2	1.0
50	-	-	4.8	3.0	1.5	0.9
75	-	-	11.1	6.5	3.0	1.7
100	-	-	19.2	11.7	5.5	3.0
125	-	-	-	-	8.6	4.8
150	-	-	-	-	12.0	6.5

PGA Series Valve Pressure Loss (bar)

PGA Series Valve Pressure Loss (bar)							METRIC	
Flow m ³ /h	Flow l/m	100-PGA Globe 2.5 cm	100-PGA Angle 2.5 cm	150-PGA Globe 3.8 cm	150-PGA Angle 3.8 cm	200-PGA Globe 5.1 cm	200-PGA Angle 5.1 cm	
0.23	3.8	0.35	0.30	-	-	-	-	
0.6	10	0.36	0.32	-	-	-	-	
1.2	20	0.38	0.35	-	-	-	-	
3	50	0.41	0.38	-	-	-	-	
6	100	0.43	0.38	0.10	0.07	-	-	
9	150	0.48	0.51	0.22	0.14	0.08	0.07	
12	200	-	-	0.38	0.23	0.12	0.07	
15	250	-	-	0.61	0.36	0.17	0.10	
18	300	-	-	0.86	0.51	0.24	0.13	
21	350	-	-	1.16	0.70	0.33	0.18	
24	400	-	-	-	-	0.43	0.23	
27	450	-	-	-	-	0.54	0.30	
30	500	-	-	-	-	0.66	0.36	
34	568	-	-	-	-	0.83	0.45	

PGA Series Temperature Rating

Water Temperature	Continuous Pressure
73° F	150 psi
80° F	132 psi
90° F	112 psi
100° F	93 psi
110° F	75 psi

PGA Series Temperature Rating

PGA Series Temperature Rating		METRIC
Water Temperature	Continuous Pressure	
23° C	10.4 bar	
27° C	9.1 bar	
32° C	7.7 bar	
38° C	6.4 bar	
43° C	5.2 bar	

PEB / PESB Series

Best-in-class Professional Series Plastic Irrigation Valves

Features

- Durable glass-filled nylon construction with fabric-reinforced rubber diaphragm for long life and reliable performance
- Globe configuration
- Normally closed, forward flow design
- Slow closing to prevent water hammer and subsequent system damage
- Low flow capability for a wide range of applications
- One-piece solenoid design with captured plunger and spring for easy servicing. Prevents loss of parts during field service
- Flow control handle adjusts water flows as needed
- Manual internal bleed manually operates the valve without allowing water into the valve box; allows pressure regulator to be adjusted without turning the valve on at the controller first
- Manual external bleed permits flushing debris from the system. Recommended for system start up and after repairs
- Stainless steel studs molded into the body. Bonnet can be attached and removed more easily and more often without damaging threads
- Nylon scrubber scrapes a stainless steel screen to clean and break down grit and plant material. Prevents debris build-up and clogging (PESB Series only)
- Five-year trade warranty

Specifications

- Pressure: 20 to 200 psi (1,4 to 13,8 bar)
- Flow without PRS-D option: 0.25 to 200 GPM (0,06 to 45 m³/h; 0,02 to 12,60 l/s)
- Flow with PRS-D option: 5 to 200 GPM (1,14 to 45 m³/h; 0,32 to 12,60 l/s)
- Temperature: Up to 150° F (66° C)
- 24VAC 50/60Hz (cycles/sec) solenoid power requirement
- Inrush current: 0.41A (9.9VA) at 60Hz
- Holding current: 0.14A (3.43VA) at 60Hz
- Solenoid coil resistance: 30-39 Ohms, nominal

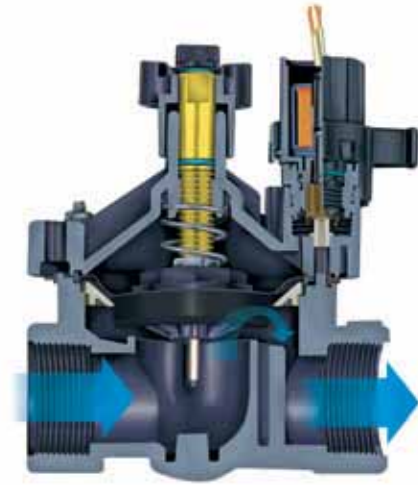

PEB Cutaway

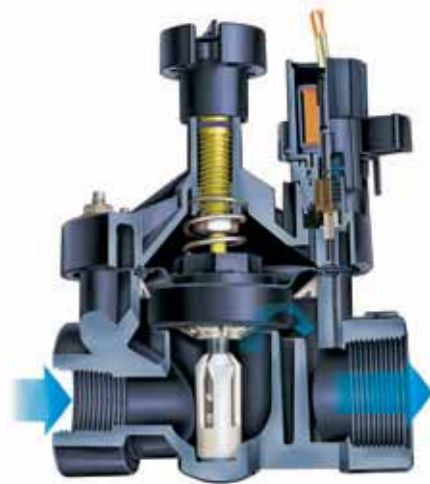

PESB Cutaway



200-PEB



200-PESB

How To Specify

100 - PEB - PRS-D

Size	Model	Optional Feature
100: 1" (26/34)	PEB	PRS-Dial: pressure regulating module (must be ordered separately)
150: 1½" (40/49)		
200: 2" (50/60)		

Note: Valve and PRS-Dial module must be ordered separately. For non-U.S. applications, it is necessary to specify NPT or BSP thread type.

PEB / PESB Series (cont.)

Options

- Accommodates optional, field-installed PRS-D pressure regulating module to ensure optimum sprinkler performance
- Accepts latching solenoid for use with Rain Bird battery-operated controllers
- Optional purple flow control handle for non-potable water applications PEB-NP-HAN1 (1"); PEB-NP-HAN2 (1 1/2" and 2")

Dimensions

Model	Height	Length	Width
• 100-PEB and 100-PESB:	6½" (16.5 cm)	4" (10.2 cm)	4" (10.2 cm)
• 150-PEB and 150-PESB:	8" (20.3 cm)	6" (15.2 cm)	6" (15.2 cm)
• 200-PEB and 200-PESB:	8" (20.3 cm)	6" (15.2 cm)	6" (15.2 cm)

Note: The PRS-Dial option adds 2" (5.1 cm) to valve height

Models

- 100-PEB and 100-PESB: 1" (26/34)
- 150-PEB and 150-PESB: 1½" (40/49)
- 200-PEB and 200-PESB: 2" (50/60)

BSP threads available; specify when ordering

Recommendations

1. Rain Bird recommends flow rates in the supply line not to exceed 7.5 ft/sec (2.29 m/s) in order to reduce the effects of water hammer
2. For flows below 5 gpm (1.14 m³/h; 19.2 l/m), Rain Bird recommends use of upstream filtration to prevent debris from collecting below the diaphragm
3. For flows below 10 gpm (2.27 m³/h; 37.8 l/m) Rain Bird recommends the flow control stem be turned down two full turns from the fully open position
4. For PRS-Dial applications, Rain Bird recommends the installation of a pressure-regulating master valve or inline pressure regulator when the inlet pressure exceeds 100 psi (6.9 bar)

PEB and PESB Series Valve Pressure Loss (psi)

Flow gpm	100-PEB 1"	150-PEB 1½"	200-PEB 2"
0.25	0.8	-	-
0.5	1.0	-	-
1	1.3	-	-
5	1.7	-	-
10	1.8	-	-
20	2.9	3.9	-
30	5.6	3.6	-
40	10.0	3.5	-
50	15.6	3.6	4.8
75	-	5.4	4.5
100	-	9.6	5.2
125	-	14.6	8.2
150	-	21.2	11.8
175	-	-	15.5
200	-	-	19.5

PEB and PESB Series Valve Pressure Loss (bar) METRIC

Flow m³/h	Flow l/m	100-PEB 2.5 cm	150-PEB 3.8 cm	200-PEB 5.1 cm
0.06	1	0.06	-	-
0.3	5	0.09	-	-
0.6	10	0.10	-	-
1.2	20	0.12	-	-
3	50	0.15	-	-
6	100	0.32	0.26	-
9	150	0.68	0.24	-
12	200	-	0.26	0.33
15	250	-	0.33	0.32
18	300	-	0.42	0.32
21	350	-	0.57	0.34
24	400	-	0.74	0.41
27	450	-	0.92	0.51
30	500	-	1.14	0.64
33	550	-	1.38	0.77
36	600	-	-	0.90
39	650	-	-	1.04
42	700	-	-	1.18
45	757	-	-	1.34

Notes

1. Loss values are with flow control fully open
2. PRS-Dial recommended for use in shaded area only

PESB-R Series Valves

Durable Plastic – chlorine resistant Professional Plastic Irrigation Valves for reclaimed water irrigation applications

Features

- Plastic diaphragm and scrubber components molded of chlorine- and chemical-resistant plastic material
- Durable glass-filled nylon construction for long life and heavy-duty performance at 200 psi (13,80 bars) pressure
- Stainless steel studs molded into the body. Bonnet can be attached and removed easily without damaging threads
- One-piece solenoid design with captured plunger and spring for easy servicing. Prevents loss of parts during field service
- External bleed protects the solenoid ports from debris when system is flushed
- Internal bleed operates the valve without allowing water into the valve box; allows pressure regulator to be adjusted without turning on the valve at the controller first
- Slow closing to prevent water hammer and subsequent system damage
- Scrubber mechanism scrapes stainless steel screen clean to break down grit and plant material
- Purple flow control handle standard on PESB-R Series valves
- Five-year trade warranty

Options (order separately)

- Accommodates optional, field installed PRS-D pressure regulating module to ensure optimum sprinkler performance
- Accepts latching solenoid for use with Rain Bird battery-operated controllers up to 150 psi (10,35 bars)



PESB-R Cutaway

Valves

150-PESB-R



How To Specify

100 - PESBR - PRS-D

Size	Model	Optional Feature
100: 1" (26/34)	PESB-R: scrubber model	PRS-Dial: pressure regulating module (must be ordered separately)
150: 1½" (40/49)		
200: 2" (50/60)		

Note: Valve and PRS-Dial module must be ordered separately.

PESB-R Series (cont.)

Specifications

- Pressure: 20 to 200 psi (1.38 to 13.80 bar)
- Flow: 0.25 to 200 gpm (0.06 to 45.40 m³/h; 0,02 to 12,60 l/s)
- Flow with PRS-Dial: 5 to 200 gpm (1.14 to 45.40 m³/h; 0,32 to 12,60 l/s)
- Temperature: Up to 150° F (66° C)
- 24VAC 50/60Hz (cycles/sec) solenoid power requirement
- Inrush current: 0.41A (9.9VA) at 60Hz
- Holding current: 0.14A (3.43VA) at 60Hz
- Solenoid coil resistance: 30-39 Ohms, nominal

Dimensions

Model	Height	Length	Width
• 100-PESB-R	6½" (16.5 cm)	4" (10.2 cm)	4" (10.2 cm)
• 150-PESB-R	8" (20.3 cm)	6" (15.2 cm)	6" (15.2 cm)
• 200-PESB-R	8" (20.3 cm)	6" (15.2 cm)	6" (15.2 cm)

Note: The PRS-Dial option adds 2" (5.1 cm) to valve height

Models

- 100-PESB-R: 1" (26/34)
- 150-PESB-R: 1½" (40/49)
- 200-PESB-R: 2" (50/60)
- 100-PESB-R-WK: 1" (26/34) Conversion Kit
- 150-PESB-R-WK: 1½" (40/49) Conversion Kit
- 200-PESB-R-WK: 2" (50/60) Conversion Kit

BSP threads available, specify when ordering

Recommendations

1. Rain Bird recommends flow rates in the supply line not to exceed 7.5 ft/sec (2.29 m/s) in order to reduce the effects of water hammer
2. For flows below 5 gpm (1.14 m³/h; 19.21 l/m), Rain Bird recommends use of upstream filtration to prevent debris from collecting below the diaphragm
3. For flows below 10 gpm (2.27 m³/h; 37.8 l/m) Rain Bird recommends the flow control stem be turned down two full turns from the fully open position

PESB-R Series Valve Pressure Loss (psi)			
Flow gpm	100-PESB-R 1"	150-PESB-R 1½"	200-PESB-R 2"
0.25	1.6	-	-
0.5	3.0	-	-
1	1.8	-	-
5	2.9	-	-
10	2.9	-	-
20	2.6	3.5	-
30	5.8	3.1	-
40	10.2	2.3	-
50	16.0	2.1	3.7
75	-	4.3	3.3
100	-	7.5	4.7
125	-	11.9	8.6
150	-	17.0	12.6
175	-	-	14.8
200	-	-	18.9

PESB-R Series Valve Pressure Loss (bar)				METRIC
Flow m ³ /h	Flow l/m	100-PESB-R 2.5 cm	150-PESB-R 3.8 cm	200-PESB-R 5.1 cm
0.06	1	0.11	-	-
0.3	5	0.13	-	-
0.6	10	0.15	-	-
1.2	20	0.20	-	-
3	50	0.19	-	-
6	100	0.32	0.22	-
9	150	0.69	0.16	-
12	200	-	0.16	0.25
15	250	-	0.24	0.24
18	300	-	0.33	0.25
21	350	-	0.45	0.30
24	400	-	0.59	0.38
27	450	-	0.75	0.53
30	500	-	0.91	0.67
33	550	-	1.10	0.82
36	600	-	-	0.92
39	650	-	-	1.00
42	700	-	-	1.13
45	757	-	-	1.30

Notes

1. Loss values are with flow control fully open
2. PRS-Dial recommended for use in shaded area only

EFB-CP Series Brass Valves

Highly durable Brass Irrigation Valves - Globe Configuration

Features

- Reliable performance even in dirty water applications. Self-flushing filter resists debris build-up
- Rugged red brass construction for longer life
- Durable, fabric-reinforced diaphragm composed of EPDM, a rubber material which is chlorine and chemical resistant
- Normally closed, reverse flow design ensures valve will fail in the closed position if a tear or rip in the diaphragm occurs. Prevents flooding, water waste and landscape damage
- Slow closing to prevent water hammer and subsequent system damage
- One-piece solenoid design with captured plunger and spring for easy servicing. Prevents loss of parts during field service
- Manual internal bleed operates the valve without allowing water into the valve box. Allows pressure regulator adjustment without turning on the controller
- Manual external bleed permits flushing debris from the system. Recommended for system start up and other repairs
- Contamination-proof, self-flushing filter screen resists debris build-up. Water flow continuously flushes the screen, dislodging particles and debris before they can accumulate and clog the filter
- Reclaimed water compatible: all models now feature EPDM diaphragms and chlorine-resistant parts as standard equipment
- Three-year trade warranty



EFB-CP Cutaway



Purple handle cover included to designate non-potable water

125-EFB-CP

Options

- Accommodates optional, field installed PRS-D pressure regulating module to ensure optimum sprinkler performance. Regulates up to 100 psi (6.9 bar)
- Accepts latching solenoid for use with Rain Bird battery-operated controllers up to 150 psi (10,35 bar)
- Compatible with ESP-LXD decoders

Specifications

- Pressure: 15 to 200 psi (1,04 to 13,80 bar)
- Flow with/without PRS-D: 5 to 200 GPM (1.14 to 45,40 m³/h; 0,32 to 12,60 l/s)
- Temperature: up to 150° F (66° C)
- 24VAC 50/60Hz (cycles/sec) solenoid power requirement
- Inrush current: 0.41A (9.9VA) at 60Hz
- Holding current: 0.14A (3.43VA) at 60Hz
- Solenoid coil resistance: 30-39 Ohms, nominal

Dimensions

Model	Height	Length	Width
• 100-EFB-CP:	6" (15.2 cm)	4½" (11.4 cm)	3¼" (8.3 cm)
• 125-EFB-CP:	5¾" (14.6 cm)	5" (12.7 cm)	3¼" (8.3 cm)
• 150-EFB-CP:	6½" (16.5 cm)	5½" (14 cm)	4½" (11.4 cm)
• 200-EFB-CP:	7" (17.8 cm)	6¾" (17.1 cm)	5¾" (14.6 cm)

Note: The PRS-Dial option adds 2" (5.1 cm) to the valve height

Models

- 100-EFB-CP: 1" (26/34)*
- 125-EFB-CP: 1¼" (33/42)
- 150-EFB-CP: 1½" (40/49)*
- 200-EFB-CP: 2" (50/60)*

* BSP threads available; specify when ordering

Recommendations

1. Rain Bird recommends flow rates in the supply line not to exceed 7.5 ft/sec (2.29 m/s) in order to reduce the effects of water hammer
2. For flows below 5 gpm (1.14 m³/h; 19.21 l/m), Rain Bird recommends use of upstream filtration to prevent debris from collecting below the diaphragm
3. For flows below 10 gpm (2.27 m³/h; 37.8 l/m) Rain Bird recommends the flow control stem be turned down two full turns from the fully open position

How To Specify

100 - EFB-CP - PRS-D

Size	Model	Optional Feature
100: 1"	EFB-CP	PRS-Dial: pressure regulating module (must be ordered separately)
125: 1¼"		
150: 1½"		
200: 2"		

Note: Valve and PRS-Dial module must be ordered separately.

EFB-CP Series (cont.)

EFB-CP Series Valve Pressure Loss (psi)				
Flow gpm	100 EFB-CP 1"	125 EFB-CP 1¼"	150 EFB-CP 1½"	200 EFB-CP 2"
5	0.2	-	-	-
10	0.7	-	-	-
15	1.2	-	-	-
20	2.1	1.4	2.3	0.5
30	5	2.3	2.9	0.6
40	8.2	4.1	2	0.8
50	13	6.8	3.3	1.1
60	-	9.8	4.6	1.8
80	-	16.5	7.5	2.4
100	-	-	11.8	3.8
120	-	-	16.6	5.9
140	-	-	-	7.8
160	-	-	-	10
180	-	-	-	12.5
200	-	-	-	15.8

EFB-CP Series Valve Pressure Loss (bar)					METRIC
Flow m³/h	Flow l/m	100 EFB-CP 2.5 cm	125 EFB-CP 3.2 cm	150 EFB-CP 3.8 cm	200 EFB-CP 5.1 cm
1	19	0.01	-	-	-
3	50	0.07	-	-	-
6	100	0.27	0.14	0.19	0.04
9	150	0.56	0.28	0.14	0.05
12	200	-	0.53	0.25	0.09
15	250	-	0.82	0.38	0.14
18	300	-	1.12	0.51	0.16
21	350	-	-	0.70	0.23
24	400	-	-	0.91	0.30
27	450	-	-	1.13	0.40
30	500	-	-	-	0.49
33	550	-	-	-	0.58
36	600	-	-	-	0.68
39	650	-	-	-	0.79
42	700	-	-	-	0.92
45	757	-	-	-	1.09

- Notes**
- Loss values are with flow control fully open
 - PRS-Dial module recommended for all flow rates

300-BPE/300-BPES Brass Valves

3" Brass Master Valves - Globe and angle configuration

Features

- Unique hybrid construction featuring durable red brass body and glass-filled nylon bonnet for long life at a value price
- Normally closed, forward flow design
- Slow closing to prevent water hammer and subsequent system damage
- Robust solenoid provides dependable performance even during constant operation
- Flow control handle adjusts water flows as needed and incorporates a brass thread insert for longer life
- Manual internal bleed operates the valve without allowing water into the valve box. Allows pressure regulator adjustment without turning the valve on at the controller
- Manual external bleed permits flushing debris from the system. Recommended for system start up and repairs
- Highly efficient operation with extremely low pressure loss
- **BPES only:** Patented nylon scrubber scrapes a stainless steel screen to clean and break down grit and plant material. Prevents debris build-up and clogging
- Three-year trade warranty

Options

- Accommodates field-installed PRS-D pressure regulating module to ensure optimum sprinkler performance
- Purple flow control handle for non-potable water applications (BPE-NP-HAN)
- Latching solenoid for use with Rain Bird battery-operated controllers up to 150 psi (10,4 bar)

Specifications

- Pressure: 20 to 200 psi (1,4 to 13,8 bar)
- Flow with/without PRS-D option: 60 to 300 gpm (13,6 to 68,1 m³/h; 3,78 to 18,90 l/s)
- Temperature: up to 140° F (60° C)
- Power: 24 VAC 50/60 Hz (cycles per second) solenoid
- Inrush current: 0.41 A (9.8 VA) at 60Hz
- Holding current: 0.28 A (6.7 VA) at 60Hz
- Coil resistance: 28 Ohms, nominal

How To Specify

300 - BPE - PRS-D

Model
BPE

Optional Feature
PRS-Dial: pressure
regulating module
(must be ordered
separately)

Size
3" (80/90)

Note: Valve and PRS-Dial module must be ordered separately. For non-U.S. applications, it is necessary to specify NPT or BSP thread type.



300-BPES

BPE and BPES 3" Valve Pressure Loss (psi)		
Flow gpm	Globe	Angle
60	6.6	6.8
80	5.1	5.9
100	3.2	3.5
120	1.8	1.8
140	1.8	2.1
160	2.0	2.1
180	2.2	2.0
200	2.7	2.5
250	4.0	3.4
300	4.9	4.5

BPE and BPES 3" Valve Pressure Loss (bar)			METRIC
Flow m ³ /h	Flow l/m	Globe	Angle
13.6	227	0.46	0.47
24	400	0.19	0.21
36	600	0.14	0.14
48	800	0.21	0.19
60	1000	0.29	0.26
68	1136	0.34	0.31

Notes

1. Loss values are with flow control fully open
2. PRS-Dial module recommended for all flow rates

Dimensions

Model	Height	Length	Width
• 300	13 ⁵ / ₈ " (34.61 cm)	8" (20.32 cm)	7" (17.78 cm)

Models

- 300-BPE: 3" (80/90)
- 300-BPES: 3" (80/90)

BSP threads available; specify when ordering

Recommendations

1. Rain Bird recommends flow rates in the supply line not to exceed 7.5 ft/sec (2.29 m/s) in order to reduce the effects of water hammer
2. For flows below 5 gpm (1.14 m³/h; 19.2 l/m), Rain Bird recommends use of upstream filtration to prevent debris from collecting below the diaphragm.
3. For flows below 10 gpm (2.27 m³/h; 37.8 l/m) Rain Bird recommends the flow control stem be turned down two full turns from the fully open position.



BPES Cutaway

DB Series Wire Connectors

Connections Made Easy

Features and Benefits

- Install Faster – DB Series Wire Connectors are quick to install and provide reliable moisture sealing for controller and valve electrical connections you can count on
- Simplify Inventory – This is the only wire connector you'll need! It is ideal for use on two wire decoder control systems
- Avoid Call Backs – Locating and repairing a corroded wire splice costs your business time and money. Avoid unnecessary service call backs. Use for standard controllers, valve boxes and soil moisture sensors
- Wire combinations ranging from 22ga to 8ga
- Use on connections from 24 VAC to 600 VAC
- UL 486D certified for direct burial
- The Strain Relief ensures wires are secure and won't pull apart
- Waterproof silicone sealant protects against corrosion
- UV-resistant material ensures product performance does not degrade even after long periods of exposure to sunlight

Models

- DBT020: Direct Bury Silicone Tube, Tan Wire Nut, Bag of 20
- DBRY20: Direct Bury Silicone Tube, Red Yellow Wire Nut, Bag of 20



Wire Combinations (for solid and stranded wire)

DBT020	
1-2 #10	2-6 #18
1-4 #12	1 #8 w/2 #14
1-5 #14	3 #12 w/3 #18
2-6 #16	3 #14 w/2 #18

DBRY20	
2-3 #10	2#18
2-5 #12	1 #8 w/2 #18
2-5 #14	3 #10 w/1 #18
4-6 #16	3 #12 w/3 #18
3 #14 w/2 #18	

The combinations listed are only a sample of the most common wire combinations.

PRS-Dial

Pressure Regulating Module



Features

- The PRS-Dial is an excellent means of regulating outlet pressure at the valve regardless of incoming pressure fluctuations. The visible scale makes adjustment quick and easy. The regulator fits all Rain Bird PGA, PEB, PESB, PESB-R, EFB-CP, BPE and BPES series valves
- Regulates and maintains constant outlet pressure between 15 and 100 psi (1.04 to 6.9 bar) within ± 3 psi (± 0.21 bar)
- Adjustment knob with detents permits fine-tune setting in 1/3 psi (0.02 bar) increments. Dial cartridge makes installation and adjustment quick, easy and accurate Improved spike reduction capabilities reduce water hammer
- Ergonomic design with snap-tight cover to prevent vandalism
- Waterproof dial cartridge eliminates fogging and binding
- Dial cartridge retrofits into all existing PRS-B units
- Schrader valve connects pressure hose gauge, ordered separately
- Easy field installation. PRS-Dial threads underneath the solenoid and adapter
- Corrosion-resistant glass-filled nylon for rugged performance

Operating Range

- Pressure: Up to 100 psi (6.9 bar)*
- Regulation: 15 to 100 psi (1.04 to 6.9 bar)
- Flow: Refer to chart

* While the PRS-Dial unit can withstand pressures up to 200 psi (13.8 bar), accurate pressure regulation can be maintained only up to 100 psi (6.9 bar)

Model

- PRS-D

Application Information

- Proper operation requires inlet pressure to be a minimum of 15 psi (1.04 bar) higher than desired outlet pressure
- For areas with very high pressure or uneven terrain, install sprinklers with PRS pressure regulating stems and/or SAM check valves
- When inlet pressure exceeds 100 psi (6.9 bar), a pressure regulating master valve or inline pressure regulator is required
- Rain Bird does not recommend using the pressure regulating module for applications outside the recommended flow ranges
- To reduce the effects of water hammer, Rain Bird recommends flow rates in the supply line not to exceed 7.5 ft/sec (2.29 m/s)
- For flows below 10 gpm (2.27 m³/h; 37.8 l/m), Rain Bird recommends the flow control stem be turned down two full turns from the fully open position

† Note: Valve and PRS-Dial module must be ordered separately.

Valve Flow Ranges*			
Model	gpm	m ³ /h	l/m
100-PGA	5-40	1.14-9.08	19.2-151
150-PGA	30-100	6.81-22.70	113-378
200-PGA	40-150	9.08-34.05	151-568
100-PEB	5-50	1.14-11.35	19.2-189
150-PEB	20-150	4.54-34.05	76-568
200-PEB	75-200	17.03-45.40	284-757
100-PESB/PESB-R	5-50	1.14-11.35	19.2-189
150-PESB/PESB-R	20-150	4.54-34.05	76-568
200-PESB/PESB-R	75-200	17.03-45.40	284-757
100-EFB-CP	5-50	1.14-11.35	19.2-189
125-EFB-CP	20-80	4.54-18.16	76-302
150-EFB-CP	20-120	4.54-31.78	76-529
200-EFB-CP	20-200	4.54-45.40	76-757
300-BPE	60-300	13.62-68.10	227-1136
300-BPES	60-300	13.62-68.10	227-1136

* These are the valve flow ranges. The PRS-Dial regulates only up to 100 psi (6.9 bar)



Quick-Coupling Valves

Convenient water access in potable and non-potable systems

Features

- Optional locking cover on models 33-DLRC, 44-LRC, 5-LRC, 33-DNP, 44-NP, and 5-NP (use 2049 key to unlock). Metal cover on model 7 only
- One-piece body design (models 3-RC, 5-RC and 7)
- Two-piece body design for easy servicing (models 33-DRC, 44-LRC, 44-RC, 33-DNP, and 44-NP)
- Strong corrosion-resistant stainless steel spring prevents leakage
- Thermoplastic cover for durability
- 33-DNP, 44-NP, and 5-NP covers marked with "Do Not Drink!" warnings in English and Spanish
- Three-year trade warranty

Specifications

- Pressure: 5 to 125 psi (0.35 to 8.63 bar)
- Flow: 10 to 125 gpm (2.27 to 28.38 m³/h; 37.8 to 473 l/m)
- 33-DNP, 44-NP and 5-NP flow: 10 to 70 gpm (2.27 to 15.89 m³/h; 37.8 to 265 l/m)

Dimensions (height)

- 3-RC: 4¹/₄" (10.8 cm)
- 44-RC: 6" (15.2 cm)
- 7: 5³/₄" (14.6 cm)
- 33-DRC: 4³/₈" (11.1 cm)
- 44-LRC: 6" (15.2 cm)
- 33-DNP: 4³/₈" (11.1 cm)
- 33-DLRC: 4⁵/₈" (11.7 cm)
- 5-RC: 5¹/₂" (14.0 cm)
- 44-NP: 6" (15.2 cm)
- 5-LRC: 5¹/₂" (14.0 cm)
- 5-NP: 5¹/₂" (14.0 cm)

Models

- 3-RC: 3/4" (20/27) Rubber Cover, 1-Piece Body
- 33-DRC: 3/4" (20/27) Double Track Key Lug, Rubber Cover, 2-Piece Body
- 33-DLRC: 3/4" (20/27) Double Track Key Lug, Locking Rubber Cover, 2-Piece Body
- 44-RC: 1" (26/34) Rubber Cover, 2-Piece Body
- 44-LRC: 1" (26/34) Locking Rubber Cover, 2-Piece Body
- 5-RC: 1" (26/34) Rubber Cover, 1-Piece Body
- 5-LRC: 1" (26/34) Locking Rubber Cover, 1-Piece Body
- 7: 1 1/2" (40/49) Metal Cover, 1-Piece Body
- 5-RC-BSP: 1" (26/34) Rubber Cover, 1-Piece Body, BSP threaded
- 5-LRC-BSP: 1" (26/34) Locking Rubber Cover, 1-Piece Body, BSP threaded
- 33-DNP: 3/4" (20/27) Non-potable, Purple Locking Rubber Cover, 2-Piece Body
- 44-NP: 1" (26/34) Non-potable, Purple Locking Rubber Cover, 2-Piece Body
- 5-NP: 1" (26/34) Non-potable, Purple Locking Rubber Cover, 1-Piece Body

Note: For non-US applications, it is necessary to specify NPT or BSP thread type

Quick-Coupling Valves Pressure Loss (psi)

Flow	3-RC	33-DRC 33-DLRC 33-DNP	44-RC 44-LRC 44-NP	5-RC 5-LRC 5-NP	7
gpm	3/4"	3/4"	1"	1"	1 1/2"
10	1.8	2	-	-	-
15	4.7	4.3	2.2	-	-
20	7.2	7.6	4.4	-	-
30	-	-	11.5	4.1	-
40	-	-	-	7.3	-
50	-	-	-	11	1.7
60	-	-	-	15.7	2.5
70	-	-	-	21.5	3.6
80	-	-	-	-	4.9
100	-	-	-	-	8.4
125	-	-	-	-	14

Quick-Coupling Valves Pressure Loss (bar)

Flow	3-RC	33-DRC 33-DLRC 33-DNP	44-RC 44-LRC 44-NP	5-RC 5-LRC 5-NP	7	METRIC
m ³ /h	l/m	1.9 cm	1.9 cm	2.5 cm	2.5 cm	3.8 cm
2.3	38	0.12	0.12	-	-	-
4	67	0.41	0.42	0.23	-	-
5	83	0.57	0.62	0.40	-	-
6	100	-	-	0.62	-	-
7	117	-	-	0.83	0.30	-
8	133	-	-	-	0.40	-
9	150	-	-	-	0.50	-
10	167	-	-	-	0.61	-
12	200	-	-	-	0.85	0.13
14	233	-	-	-	1.15	0.18
16	267	-	-	-	1.50	0.25
22	367	-	-	-	-	0.54
28	473	-	-	-	-	0.97



Quick-Coupling Valve Cutaway



Quick Coupling Valves

Valve Keys

Quick-Coupling Keys

Features

- Key threads into top of quick-coupling valve to provide water access

Models

- 33-DK: 3/4" (20/27)
- 44-K: 1" (26/34)
- 55-K-1: 1" (26/34)*
- 7-K: 1 1/2" (40/49)*

* Available with BSP threads; specify when ordering



55-K-1

Corresponding Valve Keys

Valve	Key	Top Pipe Threads	
		Male	Female
3-RC	33-DK	3/4"	1/2"
33-DRC/33-NP	33-DK	3/4"	1/2"
44-RC/44-NP	44-K	1"	3/4"
5-RC/5-NP	55-K-1	1"	-
7	7-K	1 1/2"	1 1/4"

Corresponding Valve Keys

METRIC

Valve	Key	Top Pipe Threads	
		Male	Female
3-RC	33-DK	20/27	15/21
33-DRC/33-NP	33-DK	20/27	15/21
44-RC/44-NP	44-K	26/34	20/27
5-RC/5-NP	55-K-1	26/34	-
7	7-K	40/49	33/42

SH Series

Hose Swivel

Features

- Attaches water hose to quick-coupling valve key
- Swivels up to 360°
- Allows hose to be pulled in any direction
- Prevents hose damage

Specifications

- SH-0: 3/4" (20/27) female pipe thread x 3/4" (20/27) male hose thread
- SH-1: 1" (26/34) female pipe thread x 3/4" (20/27) male hose thread
- SH-2: 1" (26/34) female pipe thread x 1" (26/34) male hose thread
- SH-3: 1 1/2" (40/49) female pipe thread x 1" (26/34) male hose thread

Models

- SH-0
- SH-1
- SH-2*
- SH-3

* Available with BSP threads



SH-0

Locking Cover Key

Features

- Locks and unlocks the optional locking cover on quick-coupling valves
- Operates the valve marker compression lock
- Compatible with models 33-DLRC, 33-DNP, 44-LRC, 44-NP, 5-LRC, and 5-NP

Model

- 2049 Cover Key



2049

SPLICE-1

Wire Splice

Features

- Fast, reliable splicing
- UV resistant black housing is pre-filled with non-toxic lithium grease

Specifications

- Splices low voltage electrical control wires: 30 V max
- Fits wires up to
 - 5 #18, #20, or #22 AWG
 - 4 #16 AWG
 - 2 #14 AWG

Model

- SPLICE-1



SPLICE-1

Purple Valve Handle Assembly

Features

- Purple flow control handle identifies valve as part of a non-potable system
- Easily field installed
- Sizes for all Rain Bird Commercial Valves

Models

- PGA-NP-HAN1 (1" and 1 1/2" PGA Valves)
- PGA-NP-HAN2 (2" PGA Valves)
- PEB-NP-HAN1 (1" PEB/PESB Valves)
- PEB-NP-HAN2 (1 1/2" and 2" PEB/PESB Valves)
- BPE-NP-HAN (3" BPE/BPES Valves)



PEB-NP-HAN PGA-NP-HAN



BPE-NP-HAN

PVB Professional Series Valve Boxes

The PVB Series valve box provides rugged, no-nonsense dependability, with a price tag that can meet any budget

Features

- Light & durable construction
- Side ridges for additional side wall support
- Pre-molded pipe slots
- Bottom flanges to help prevent sinking
- Four colors: available in green, black, tan and purple
- Multiple configurations designed to provide tight seals and easy maintenance access
- Earth-friendly, LEED-compliant material made of 100% recycled materials (black boxes and black lids only)



6" Round Valve Box	10" Round Valve Box	Mini Standard Valve Box	Standard Valve Box	Standard Extension	Jumbo Valve Box	Jumbo Extension
SIZE						
Top Opening: 6 5/8" diameter Bottom Opening: 8 5/8" diameter	Top Opening: 10" diameter Bottom Opening: 12 1/8" diameter	Top Opening: 15" L x 9 1/2" W Bottom Opening: 18" L x 12 1/2" W x 10" H	Top Opening: 18 1/4" L x 13" W Bottom Opening: 21 1/4" L x 15 1/8" W x 12" H	Top Opening: 17" L x 11 3/4" W Bottom Opening: 18 5/8" L x 13 5/8" W x 6 3/4" H	Top Opening: 22 1/4" L x 16 3/8" W Bottom Opening: 25 1/4" L x 19 3/8" W x 12" H	Top Opening: 21 3/8" L x 15 7/8" W Bottom Opening: 22 1/8" L x 16 3/8" W x 6 5/8" H
ADDITIONAL FEATURES						
<ul style="list-style-type: none"> • Snap-in overlapping lid • Skid-resistant texture • Body built with three ridges for additional sidewall support 	<ul style="list-style-type: none"> • Overlapping lid with bolt hole and twist lock • Skid-resistant lid texture • Body built with double ridges for additional sidewall support 	<ul style="list-style-type: none"> • Our compact alternative to a standard size box • Drop-in lid • Skid-resistant lid texture 	<ul style="list-style-type: none"> • Drop-in lockable lid • Skid-resistant lid texture • Double ledge lid support • Ridge adds additional support to sidewalls 	<ul style="list-style-type: none"> • Overlapping lockable lid • Skid-resistant lid texture • Body can be used to extend the PVB Standard series • Body can be used as a 6" deep box 	<ul style="list-style-type: none"> • Drop-in lockable lid • Skid-resistant lid texture • Double ledge lid support • Ridge adds additional support to sidewalls 	<ul style="list-style-type: none"> • Overlapping lockable lid • Skid-resistant lid texture • Body can be used to extend the PVB Jumbo series • Body can be used as a 6" deep box
MODELS						
<ul style="list-style-type: none"> • PVB6RND: 6" round black body & overlapping green lid • PVB6RNDP: 6" round black body & overlapping purple lid • PVB6RNDT: 6" round black body & overlapping tan lid 	<ul style="list-style-type: none"> • PVB10RND: 10" round black body & overlapping green lid • PVB10RNDP: 10" round purple body & overlapping purple lid • PVB10RNDT: 10" round tan body & overlapping tan lid 	<ul style="list-style-type: none"> • PVBMSST: 10" mini-standard black body & drop-in green lid 	<ul style="list-style-type: none"> • PVBSTD: 12" standard black body & drop-in green lid • PVBSTDP: 12" standard purple body & drop-in purple lid • PVBSTDT: 12" standard tan body & drop-in tan lid 	<ul style="list-style-type: none"> • STDEXT body can extend the Standard Valve box by 6" in height • STDEXT body can be used as a 6" deep box to reduce digging • PVBSTDEXT: 6" black body & overlapping green lid 	<ul style="list-style-type: none"> • PVBJMB: 12" black body & drop-in green lid • PVBJMBP: 12" purple body & drop-in purple lid • PVBJMBT: 12" tan body & drop-in tan lid 	<ul style="list-style-type: none"> • PVBJBEXT: 6" black body & overlapping green lid • PVBJBEXTP: 6" purple body & overlapping purple lid • PVBJBEXTT: 6" tan body & overlapping tan lid

6" Round Lids

PVB6RNDGL: 6" round green lid

10" Round Lids

PVB10RNDGL: 10" round green lid

12" Standard Lids

PVBSTDGL: 12" standard green lid

12" Jumbo Lids

PVBJMBGL: 12" jumbo green lid

VB Series Valve Boxes

Commercial grade boxes that are loaded with a rich set of industry-leading features

Features

- **Strength and Stability** – Multiple sizes and shapes are designed with corrugated sides and wide flange bases for maximum durability, compression strength, and stability
- **Smart Lid Design** – Designed with no holes to keep out pests, beveled edges to minimize damage potential from turf equipment, and for easy hand and shovel access
- **Flexible Installations** – Interlocking stacking capabilities, extension models and pipe hole knockouts support deeper and flexible installations
- **Environmentally Friendly** – Earth-friendly, LEED-compliant material made of 100% recycled materials (black boxes and black lids only)



7 Inch Round Valve Box	10 Inch Round Valve Box	Standard Valve Box	Standard Extension	Jumbo Valve Box	Jumbo Extension	Super Jumbo Valve Box	Maxi Jumbo Valve Box
SIZE							
Bottom Diameter: 9.9 inches (25,1 cm) Height: 9.0 inches (22,9 cm)	Bottom Diameter: 13.75 inches (34,9 cm) Height: 10.0 inches (25,4 cm)	Length: 21.8 inches (55,4 cm) Width: 16.6 inches (42,2 cm) Height: 12.0 inches (30,5 cm)	Length: 20.0 inches (50,8 cm) Width: 14.75 inches (37,5 cm) Height: 6.75 inches (17,1 cm)	Length: 26.3 inches (66,8 cm) Width: 19.8 inches (50,3 cm) Height: 12.1 inches (30,7 cm)	Length: 24.4 inches (62,0 cm) Width: 17.9 inches (45,5 cm) Height: 6.75 inches (17,1 cm)	Length: 33.1 inches (84,1 cm) Width: 23.8 inches (60,5 cm) Height: 15.0 inches (38,1 cm)	Length: 40.3 inches (102,4 cm) Width: 27.1 inches (68,8 cm) Height: 18.0 inches (45,7 cm)
ADDITIONAL FEATURES							
<ul style="list-style-type: none"> • Easily removable knock-outs simplify pipe placement and reduce installation time • Four equally spaced knock-outs accommodate up to 2.0" diameter pipe 	<ul style="list-style-type: none"> • Easily removable knock-outs simplify pipe placement and reduce installation time • Four equally spaced knock-outs accommodate up to 2.0" diameter pipe 	<ul style="list-style-type: none"> • Two large center knock-outs accommodate up to 3 1/2" (8.9 cm) diameter pipe and eleven knock-outs accommodate up to 2" (5.0 cm) diameter pipe 	<ul style="list-style-type: none"> • Extension models support deeper and more flexible installations 	<ul style="list-style-type: none"> • Easily removable knock-outs simplify pipe placement and reduce installation time • Two large center knock-outs accommodate up to 3.5" diameter pipe. (Extensions do not have knock-outs) 	<ul style="list-style-type: none"> • Extension models support deeper and more flexible installations 	<ul style="list-style-type: none"> • Easily removable knock-outs simplify pipe placement and reduce installation time • Thirteen large knock-outs accommodate up to 3.5" diameter pipe 	<ul style="list-style-type: none"> • Easily removable knock-outs simplify pipe placement and reduce installation time. Six large knock-outs on the ends accommodate up to 5.0" diameter pipe and 12 knock-outs on the sides accommodate up to 3.0" diameter pipe
MODELS							
<ul style="list-style-type: none"> • VB-7RND: Black Body & Green Lid • VB-7RNDP: Black Body & Purple Lid 	<ul style="list-style-type: none"> • VB-10RND: 10" Round (Body & Green Lid) • VB-10RND-B: 10" Round (Body only) • VB-10RND-H: 10" Round (Body & Green Lid) + Lock 	<ul style="list-style-type: none"> • VB-STD: Standard (Body & Green Lid) • VB-STD-P: Standard (Body & Purple Lid) • VB-STD-B: Standard (Body only) • VB-STD-H: Standard (Body & Green Lid) + Lock 	<ul style="list-style-type: none"> • VB-STD-6EXT: Standard 6" Extension (Body & Green Lid) 	<ul style="list-style-type: none"> • VB-JMB: Jumbo (Body & Green Lid) • VB-JMBP: Jumbo (Body & Purple Lid) • VB-JMB-B: Jumbo (Body only) • VB-JMB-H: Jumbo (Body & Green Lid) + Lock 	<ul style="list-style-type: none"> • VB-JMB-6EXT-B: Jumbo 6" Extension (Body only) • VB-JMB-6EXT: Jumbo 6" Extension (Body & Green Lid) 	<ul style="list-style-type: none"> • VB-SPR-H: Super Jumbo (Body & Green Lid) + 2 Locks • VB-SPR-PL: Super Jumbo (Lid only) - Purple 	<ul style="list-style-type: none"> • VB-MAX-H: Maxi Jumbo (Body & Green Lid) + 2 Locks • VB-MAX-PL: Super Jumbo (Lid only) - Purple

LOCKING SYSTEMS

- VB-LOCK-H: Hex head 3/8" x 2 1/4" (1.0 x 5.7 cm) bolt, washer, and clip
- VB-LOCK-P: Penta head 3/8" x 2 1/4" (1.0 x 5.7 cm) bolt, washer, and clip



24 VAC Solenoid Valves Wire Sizing – 50Hz

9.8 VA Valves (EZ) with 26.5 Volt Transformers - Equivalent Feet of Circuit								
80 psi (5.5 bar) Water Pressure at Valve								
Common Wire Size	Control Wire Size							
	18 ●	16 ●	14 ●	12 ●	10 ●	8 ●	6 ●	4 ●
18	3700							
16	4600	6000						
14	5400	7400	9600					
12	6000	8600	11800	15200				
10	6500	9600	13700	18700	24200			
8	6900	10400	15400	21800	29700	38500		
6	7100	10900	16600	24300	34600	47100	60600	
4	7300	11300	17500	26300	38800	55100	74600	97000
100 psi (6.9 bar) Water Pressure at Valve								
Common Wire Size	Control Wire Size							
	18 ●	16 ●	14 ●	12 ●	10 ●	8 ●	6 ●	4 ●
18	3200							
16	4000	5200						
14	4700	6400	8300					
12	5200	7400	10200	13200				
10	5600	8300	11900	16200	20900			
8	5900	9000	13300	18900	25700	33300		
6	6100	9500	14300	21100	29900	40700	52400	
4	6300	9800	15100	22800	33500	47700	64600	83900
125 psi (8.6 bar) Water Pressure at Valve								
Common Wire Size	Control Wire Size							
	18 ●	16 ●	14 ●	12 ●	10 ●	8 ●	6 ●	4 ●
18	2900							
16	3500	4600						
14	4100	5700	7400					
12	4600	6600	9000	11700				
10	5000	7400	10500	14400	18600			
8	5300	8000	11800	16800	22800	29600		
6	5400	8400	12700	18700	26600	36200	46600	
4	5600	8700	13400	20200	29800	42300	57300	74600
150 psi (10.4 bar) Water Pressure at Valve								
Common Wire Size	Control Wire Size							
	18 ●	16 ●	14 ●	12 ●	10 ●	8 ●	6 ●	4 ●
18	2600							
16	3200	4100						
14	3700	5000	6600					
12	4100	5900	8100	10400				
10	4500	6600	9400	12800	16600			
8	4700	7100	10500	15000	20400	26400		
6	4900	7500	11400	16700	23800	32300	41600	
4	5000	7800	12000	18100	26600	37800	51300	66600
200 psi (13.8 bar) Water Pressure at Valve								
Common Wire Size	Control Wire Size							
	18 ●	16 ●	14 ●	12 ●	10 ●	8 ●	6 ●	4 ●
18	2400							
16	2900	3800						
14	3400	4700	6100					
12	3800	5500	7500	9700				
10	4100	6100	8800	11900	15500			
8	4400	6600	9800	13900	19000	24600		
6	4500	7000	10600	15500	22100	30100	38700	
4	4600	7200	11100	16800	24800	35200	47700	62000

Commercial Valve Wire Sizing Procedure

Step 1

Determine actual distance, along wire run, from controller out to the first valve on a circuit and between each succeeding valve on a multiple valve circuit. Example: (Two watt solenoid, 26.5 volt transformer, 50Hz, at 150 psi water pressure at valves.)

Step 2

Calculate the equivalent circuit length for each valve circuit on the controller. (See chart to left)

Step 3

Selecting Common Wire Size: Using the longest equivalent length calculated above, go to the appropriate valve chart and select a common wire and a control wire that are as close to the same size as possible (the common wire size should always be equal to or one size larger than the control wire size.) In the example above, the circuit for station #3 has the longest equivalent length, 7000 feet. In the chart (for this example use the chart for 150 psi water pressure at the valve and a 26.5 volt transformer) select a wire size combination of size 14 and 12 wire. Select common wire as size 12 wire. Since one common wire shall be used for all valves on the controller, you have now established the common wire size for that controller as size 12 wire.

Step 4

Sizing Circuit Control Wires: Reading only from the row for the common wire size selected in Step 3 (size 12), proceed to select each control wire size from the chart using the calculated equivalent length for each circuit.

Station #1: Equiv. Length = 1 valve x 2000 ft. = 2000 ft. select size 18 control wire

Station #2: Equiv. Length = (1 valve x 1000 ft.) + (2 valves x 2000 ft.) = 5000 ft. select size 16 control wire

Station #3: Equiv. Length = (1 valve x 500 ft.) + (2 valves x 1000 ft.) + (3 valves x 1500 ft.) = 7000 ft. select size 14 control wire

24 VAC Solenoid Valves Wire Sizing – 60Hz

9.8 VA Valves (EZ) with 26.5 Volt Transformers - Equivalent Feet of Circuit								
80 psi (5.5 bar) Water Pressure at Valve								
Common Wire Size	Control Wire Size		14 ●	12 ●	10 ●	8 ●	6 ●	4 ●
	18 ●	16 ●						
18	3200							
16	4000	5200						
14	4700	6400	8300					
12	5200	7500	10200	13200				
10	5700	8300	11900	16200	21000			
8	6000	9000	13300	18900	25800	33400		
6	6200	9500	14400	21100	30100	40900	52600	
4	6300	9800	15200	22900	33700	47800	64800	84200
100 psi (6.9 bar) Water Pressure at Valve								
Common Wire Size	Control Wire Size		14 ●	12 ●	10 ●	8 ●	6 ●	4 ●
	18 ●	16 ●						
18	2900							
16	3500	4600						
14	4100	5600	7300					
12	4600	6600	9000	11700				
10	5000	7400	10500	14300	18600			
8	5300	8000	11800	16700	22800	29500		
6	5400	8400	12700	18700	26500	36100	46500	
4	5600	8700	13400	20200	29700	42200	57200	74400
125 psi (8.6 bar) Water Pressure at Valve								
Common Wire Size	Control Wire Size		14 ●	12 ●	10 ●	8 ●	6 ●	4 ●
	18 ●	16 ●						
18	2400							
16	3000	3900						
14	3500	4800	6300					
12	3900	5600	7700	9900				
10	4300	6300	9000	12200	15800			
8	4500	6800	10000	14300	19400	25200		
6	4600	7100	10800	15900	22700	30800	39700	
4	4700	7400	11400	17200	25400	36100	48800	63500
150 psi (10.4 bar) Water Pressure at Valve								
Common Wire Size	Control Wire Size		14 ●	12 ●	10 ●	8 ●	6 ●	4 ●
	18 ●	16 ●						
18	2200							
16	2700	3500						
14	3100	4300	5600					
12	3500	5000	6800	8800				
10	3800	5600	8000	10900	14100			
8	4000	6000	8900	12700	17300	22400		
6	4100	6300	9600	14100	20100	27400	35300	
4	4200	6600	10200	15300	22600	32100	43400	56500
200 psi (13.8 bar) Water Pressure at Valve								
Common Wire Size	Control Wire Size		14 ●	12 ●	10 ●	8 ●	6 ●	4 ●
	18 ●	16 ●						
18	1800							
16	2300	2900						
14	2600	3600	4700					
12	3000	4200	5800	7500				
10	3200	4700	6800	9200	12000			
8	3400	5100	7600	10800	14700	19000		
6	3500	5400	8200	12000	17100	23300	30000	
4	3600	5600	8600	13000	19200	27300	36900	48000

Commercial Valve Wire Sizing Procedure

Step 1

Determine actual distance, along wire run, from controller out to the first valve on a circuit and between each succeeding valve on a multiple valve circuit. Example: (Two watt solenoid, 26.5 volt transformer, 60Hz, at 150 psi water pressure at valves.)

Step 2

Calculate the equivalent circuit length for each valve circuit on the controller. (See chart to left)

Step 3

Selecting Common Wire Size: Using the longest equivalent length calculated above, go to the appropriate valve chart and select a common wire and a control wire that are as close to the same size as possible (the common wire size should always be equal to or one size larger than the control wire size.) In the example below, the circuit for station #3 has the longest equivalent length, 7000 feet. In the chart (for this example use the chart for 150 psi water pressure at the valve and a 26.5 volt transformer) select a size 12 wire for both common and control wire. Since one common wire shall be used for all valves on the controller, you have now established the common wire size for that controller as size 12 wire.

Step 4

Sizing Circuit Control Wires: Reading only from the row for the common wire size selected in Step 3 (size 12), proceed to select each control wire size from the chart using the calculated equivalent length for each circuit.

EXAMPLE:

Station #1: Equiv. Length = 1 valve x 2000 ft. = 2000 ft. select size 18 control wire

Station #2: Equiv. Length = (1 valve x 1000 ft.) + (2 valves x 2000 ft.) = 5000 ft. select size 16 control wire

Station #3: Equiv. Length = (1 valve x 500 ft.) + (2 valves x 1000 ft.) + (3 valves x 1500 ft.) = 7000 ft. select size 12 control wire



The ESP-LX Basic Controller offers basic irrigation programming options you need for commercial sites. The simple dial makes programming the controller straightforward, and easy-to-understand menu options guide you through set-up. The ESP-LX Basic is the first controller to offer both English and Spanish on one dial.

With 48-station capacity, four independent programs and up to eight start times for each station the ESP-LX Basic offers flexible scheduling options.



Water Saving Tips

- A Seasonal Adjust feature is available on all Rain Bird AC-powered controllers, allowing users to easily adjust irrigation schedules to changing seasonal landscape water requirements. The ESP-LX Series Controllers also feature an automated Monthly Seasonal Adjust feature to help save water through automatic adjustments every month of the year.
- Water savings can also be optimized through daily irrigation schedule adjustments which fine-tune watering based on current weather. All ESP-LX series controllers can easily be upgraded to include smart weather-based/ET or soil moisture irrigation control capability by adding the Rain Bird ET Manager Cartridge.
- All Rain Bird controllers simplify conservation through a variety of flexible programming features. With the touch of a button, the ESP-Me can recall a previously saved "Contractor Default" irrigation program; the ESP-LX Series "Delayed Recall" feature automatically reverts to typical watering programs after a user-set time period.

Major Products							
Primary Applications	ESP-RZX	ESP-Me	ESP-SMTe	NEW ESP-LX BASIC	ESP-LXME ESP-LXMEF	ESP-LXD	TBOS II™
Residential	•	•	•				•
Light Commercial		•	•	•	•	•	•
Commercial/Industrial				•	•	•	•
Type of Controller							
Hybrid	•	•	•	•	•	•	
Solid State							•
Battery Operated							•
Indoor Location	•	•	•	•	•	•	
Outdoor Location	•	•	•	•	•	•	
Features							
Stations (up to)	8	22	22	48	48	200	4
Programs (up to)	8	4	22	4	4	4	3
Station Timing (up to)	199 min ¹	6 hr ¹	weather-based	12 hr ¹	12 hr ¹	12 hr ¹	12 hr
Number of Starts per Program (up to)	6 ³	6	N/A	8	8	8	8
Surge protection	•	•	•	•	•	•	
230VAC Option	•	•	•	•	•	•	
Master Valve/Pump Start	•	•	•	• ²	• ²	• ²	
Water Budgeting	•	•	•	• ⁶	• ⁶	• ⁶	
Individual Program/Zone Shut-Off	•	•	•	•	•	•	
Rain Delay	•	•	•	•	•	•	
Battery Programmable	•	•	•	•	•	•	•
Sensor Terminals, Status Indicator and Override	•	•	•	•	•	•	
Delay Between Stations (up to)		9 hrs	9 hrs	0 - 10 min.	0 - 10 min.	0 - 10 min.	
Flow Sensing					•	•	
Simultaneous Multi-Station Operation				•	•	•	•
Cycle + Soak™			•	•	•	•	
Overlapping Programs				•	•	•	
Manual On/Off	•	•	•	•	•	•	•
Remote Control Compatible	•	•	•	•	•	•	
Diagnostic Test			•	•	•	•	
Diagnostic Circuit Breaker	•	•	•	•	•	•	
Out-of-Valve Box Programming							•
Submersible (up to)							3.3 ft (1 m)
Vandal/Tamper Resistant							•
Self-Cleaning Solenoid							•
Low Battery Indicator							•
Save / Restore Programs	•	•	•	•	•	•	•
Master Valve ON/OFF by Station		•	•	•	•	•	•
Total Run Time Calculator by Program		•	•	•	•	•	•
Bypass Rain Sensor by Station	•	•	•	•	•	•	
Programming Schedule							
7 Day-of-Week	•	•	•	•	•	•	•
1-7 Variable Cycle		•	•	•	•	•	•
1-31 Variable Cycle	•	•	•	•	•	•	
Odd/Even Cycle	•	•	•	•	•	•	
Odd 31st		•	•	•	•	•	•
365-Day Calendar	•	•	•	•	•	•	
Event Day Off			•	•	•	•	
Central Control Compatibility							
Maxicom ^{2®} and SiteControl Upgradeable							
IQ™ Upgradeable					•	•	
Cabinet							
Plastic-Indoor	•	•	•				
Plastic-Outdoor	•	•	•				•
Powder-Coated Metal Outdoor				•	•	•	
Stainless Steel Pedestal				•	•	•	
Powder-Coated Metal Pedestal				•	•	•	
Hardware/Accessories							
Two-Wire Decoders and Accessories						•	
Rain Sensor	•	•		•	•	•	•
Flow Sensor					ESP-LXMEF only	•	
ET Manager™ Cartridge					•	•	

¹ With water budgeting, timing can be extended ² Programmable by station ³ 6 independent start times per zone ⁴ Selectable for each program and by month

ESP-RZX Series Controller

4, 6, 8 Fixed Station Indoor or Outdoor Contractor Grade Controller for Residential Use

Features

- Flexible scheduling features that make the controller ideal for a wide variety of applications including residential and light-commercial irrigation systems
- Zone-to-Zone Copying. Copy a zone program to the next zone with 2 pushes of a button
- Easy to Use. Zone-based programming modeled after the simplicity of a DVR, so homeowners will get it
- 4, 6, and 8 Zone Models. Indoor and outdoor units available to meet any installation need
- Contractor Default™. Save your custom program into the memory of the controller with 2 pushes of a button
- Contractor Rapid Programming™. Automatically copies the watering start times and dates from zone 1 to all other zones at initial programming
- Zone-to-Zone Copying. Copy a zone program to the next zone with 2 pushes of a button
- Contractor Default™. Save your custom program into the memory of the controller with 2 pushes of a button
- Flexible Programming Features. Weather sensor bypass for all zones or by individual zone; 6 user-defined start times and flexible watering day options per zone
- Advanced Electronics. Integrated diagnostics to detect wiring problems and a non-volatile memory
- 4 Watering Days options by zone: Custom days of week, ODD calendar days, EVEN calendar days, Cyclic (every 1 – 14 days)
- Manually water ALL or SINGLE zone on demand
- Advanced Features : Electronic diagnostic circuit breaker , Contractor Rapid Programming™ and “Copy previous Zone” for faster initial set up, Contractor Default™ Save / Restore , Weather Sensor bypass, Weather Sensor bypass by Zone

Operating Specifications

- Station timing: 0 to 199 min
- Seasonal Adjust: -90% to +100%
- Independent schedule per zone
- 6 Start Times per zone
- Program Day Cycles include Custom days of the week, Odd, Even, & Cyclical dates
- Manual SINGLE zone
- Manual ALL zones

Electrical Specifications

- Input required: 120 VAC ± 10%, 60Hz
- International models; 230 VAC ± 10%, 50Hz
- Output: 24 VAC 650mA
- Power back-up: 2 x AAA batteries maintain time and date while nonvolatile memory maintains the programming

Certifications

- UL, cUL, CE, C-Tick, FCC Part 15, Industry Canada ICES-03, IRAM S-Mark, India STQC, Israel, SII, Saudi Arabia SASO, South Africa SABS

Models

Indoor Models

- RZX4i-120V: Indoor 4 Station ESP-RZX (120V)
- RZX6i-120V: Indoor 6 Station ESP-RZX (120V)
- RZX8i-120V: Indoor 8 Station ESP-RZX (120V)
- RZX4i-230V: Indoor 4 Station ESP-RZX (230V)
- RZX6i-230V: Indoor 6 Station ESP-RZX (230V)
- RZX8i-230V: Indoor 8 Station ESP-RZX (230V)
- RZ4i-230V: Indoor 4 Station ESP-RZ (230V)
- RZ6i-230V: Indoor 6 Station ESP-RZ (230V)
- RZ8i-230V: Indoor 8 Station ESP-RZ (230V)
- RZX4i-ARG: Indoor 4 Station ESP-RZX (Argentina Only)
- RZX6i-ARG: Indoor 6 Station ESP-RZX (Argentina Only)
- RZX8i-ARG: Indoor 8 Station ESP-RZX (Argentina Only)

Outdoor Models

- RZX4-120V: Outdoor 4 Station ESP-RZX (120V)
- RZX6-120V: Outdoor 6 Station ESP-RZX (120V)
- RZX8-120V: Outdoor 8 Station ESP-RZX (120V)
- RZX4-230V: Outdoor 4 Station ESP-RZX (230V)
- RZX6-230V: Outdoor 6 Station ESP-RZX (230V)
- RZX8-230V: Outdoor 8 Station ESP-RZX (230V)
- RZX4-AUS: Outdoor 4 Station ESP-RZX (Australia Only)
- RZX6-AUS: Outdoor 6 Station ESP-RZX (Australia Only)
- RZX8-AUS: Outdoor 8 Station ESP-RZX (Australia Only)



ESP-Me Series Controllers

The industry's most flexible irrigation controller solution. Supports up to 22 stations

Features

- Large LCD display with easy to navigate user interface
- Rain Sensor input with override capability
- Master valve/pump start circuit
- Non-Volatile (100 year) storage memory
- Remotely Programmable under 9V battery power (not included)
- Program based scheduling allows 4 individual programs with 6 independent start times per program for 24 total start times
- Watering schedule options: By days of week, ODD calendar days, EVEN calendar days, or Cyclic (every 1 – 30 days) Advanced Features
- Advanced diagnostics and short detection with LED alert
- Contractor Default™ Program Save/Restore saved program(s)
- Rain Sensor bypass by Station
- Total Run Time Calculator by program
- One Touch manual watering
- Delay Watering up to 14 days (applies only to stations not set to ignore Rain Sensor)
- Manual Watering option by program or station
- Seasonal Adjust applied to all programs or individual program
- Adjustable delay between valves (default set to 0)
- Master Valve on/off by station

Operating Specifications

- Station timing: 1 minute to 6 hours
- Seasonal Adjust: 5% to 200%
- Max operating temperature: 149°F (65°C)

Electrical Specifications

- Input Required: 120VAC ± 10%, 60Hz
(International models: 230/240VAC ± 10%, 50/60Hz)
- Master Valve/Pump Start Relay
- Operating Voltage: 24VAC 50/60Hz
- Max Coil Inrush: 11VA
- Max Coil Holding: 5VA
 - Idle/Off power draw 0.06 amps at 120VAC
- Power back-up not required. Nonvolatile memory permanently saves the current programming and a 10 year life lithium battery maintains the controllers time and date during power outages.

Certifications

- UL, cUL, CE, CSA, C-Tick, FCC Part 15b, WEEE, S-Mark, IP24

Dimensions

- Width: 10.7" (27,2 cm)
- Height: 7.7" (19,5 cm)
- Depth: 4.4" (11,2 cm)

North America Models (120VAC)

- Controller Base Models
 - ESP4ME1: 4 station indoor model
 - ESP4ME: 4 station outdoor model*
- Modules
 - ESPSM3: 3 station module
 - ESPSM6: 6 station module (compatible with ESP-Me Series controllers only)

Accessories

- PIGTAIL: UL approved pig tail

**Also available in 230VAC and 240VAC models*



ESP-Me Series Controller
and Modules

ESP-SMTe Smart Modular Control System

4 to 22 Station Indoor or Outdoor Smart Modular Control System for Residential and Light Commercial Use



Features

- English/Spanish Button easily switches the display text between languages
- Weather Sensor sends rainfall and temperature data to the controller
- Large LCD display with easy to use interface
- Non-Volatile (100- year) program memory
- Remotely Programmable under 9V battery power (not included)
- Programming tutorial assures efficient and accurate scheduling
- Watering occurs only as needed and can be restricted to selected days of the week, odd or even calendar days or at set intervals (cyclic)
- Grow-in watering option allows a time based schedule for new plants for a programmed period of time
- Cycle+Soak™ feature for each zone prevents runoff based on soil type, precipitation rate and landscape slope
- Any zone can be switched to Time Based programming (for example, to operate a pond pump)
- Copy Zone to Zone feature allows the contractor to copy a zone program from one zone to another
- Event Days Off allows you to select up to four specific dates to block watering
- Rainfall Shutdown suspends all irrigation if the measured rainfall exceeds a user set threshold
- Cold Weather Shutdown suspends all irrigation to prevent potential freeze damage
- Contractor Default™ allows the controller zone settings to be saved/ restored
- Next Irrigation Estimate shows an estimated schedule up to three weeks in advance
- Weather Log holds historical weather data for 30 days
- Event Log by date or by zone
- Manual Watering allows immediate watering of a selected zone or all zones
- Enable or disable Master Valve by zone
- Advanced diagnostics and short circuit detection

Operating Specifications

- 2 Watering Windows per zone
- Fine Tune watering adjustment -60% to +60% by zone
- Programmable delay between zones (default set to 3 seconds)

Electrical Specification

- Input Required: 120VAC +/- 10%, 60 Hz
- Output: 25.5VAC 1A
- IP 24

- Valve/solenoid capacity (two 24VAC, 7VA solenoids plus a master valve)
- Nonvolatile memory saves programming
- 10 year life lithium battery maintains the controller's time and date
- Master Valve/Pump Start Relay:
 - Operating Voltage: 24VAC 50/60Hz
 - Max Coil Inrush: 11VA
 - Max Coil Holding: 5VA
- Idle/Off power draw 0.06 amps at 120VAC
- Certifications
 - WaterSense approved, meets EPA criteria for high-performing, water efficient products.
 - UL, cUL, FCC Part 15b

Dimensions

- Width: 10.7 in. (27,2 cm)
- Height: 7.7 in. (19,5 cm)
- Depth: 4.4 in. (11,2 cm)
- Mounting Bracket
 - Maximum reach: 7.0" (17.8 cm)

Models

- Control System Base Models (*includes ESP-SMTe controller & weather sensor*)
 - ESP4SMTEi – 4 station indoor* - 120V
 - ESP4SMTE – 4 station outdoor* -120V
- Upgrade Model (*includes ESP-SMTe controller panel & weather sensor*)
 - ESPSMTEUPG – Kit to Upgrade existing ESP-Modular or ESP-Me Controllers**
- Modules
 - ESPSM3 – 3-station expansion module
 - ESPSM6 – 6 station expansion module

* To expand up to 22 stations, use ESPSM3 or ESPSM6 modules – Station Expansion Modules

** Applies to ESP-M controllers manufactured after April, 2005

Note: All ESP-SMTe models come with a heavy-duty adjustable bracket and 25 feet of 18-2 UV-rated non-burial wire for connection between the controller panel and the weather sensor pod. Up to 200 feet of appropriate wire may be spliced to extend range.



ESP-SMTe Smart Modular Control System

ESP-LX Basic Controllers

The easiest to use commercial controller



Features

- Flexible features and modular options make the controller ideal for a wide variety of applications including light commercial, commercial, and industrial irrigation Systems
- ESP Extra-Simple Programming user interface and large LCD display with softkey text labels
- Simple, Three-Step Programming can be done using minimal dial positions. Additional programming options can be accessed through the Basic Setup and Station Timing dial positions
- Two Languages, One Dial- English and Spanish are both on one simple dial making it easy for everyone to install and maintain
- Larger Station Count compared to competitive commercial controllers. The ESP-LX Basic base model has 12 stations and has capacity for 48 stations using 4-, 8- and 12-station modules
- Water Management Features: SimulStations™ (Operate two stations simultaneously), Cycle+Soak™, Station Delay, Seasonal Adjust, Sensor & Master Valve Programmable by Station
- Contractor Default™ allows the user to create a customized default program that can be automatically recalled up to 90 days in the future. This allows a temporary schedule to be created for new seed or a fast fix
- Enhanced Diagnostic Feedback™ with RASTER™ Wiring Test with external alarm light and on-screen messaging alert the user of conditions that may disrupt controller operation

Electrical Specifications

- Input required: 120 VAC ± 10%, 60Hz
- Output: 26.5 VAC 1.9A
- Power back-up: Lithium coin-cell battery maintains time and date while nonvolatile memory maintains the programming
- Multi-valve capacity: Maximum 2 24 VAC, 7VA solenoid valves simultaneous operation including plus master valve

Certifications

- UL, CUL, CE, CSA, C-Tick, FCC Part 15

Controller Hardware

- Plastic, locking, UV resistant, wall-mount case
- Optional Metal/Stainless Steel Case & Pedestal
- 12-station base unit expandable to 48 stations with 4-, 8-, & 12-Station Modules

Models

- ESPLXBASIC: ESP-LX Basic 12 Station Controller, 120VAC
- ESPLXBFP: ESP-LX Basic Controller Front Panel
- LXBASEMOD: ESP-LX Series Base Module for LX Basic and non flow LXME
- ESPLXMSM4: 4-Station Module for ESP-LXME and ESP-LX Basic Controller
- ESPLXMSM8: 8-Station Module for ESP-LXME and ESP-LX Basic Controller
- ESPLXMSM12: 12-Station Module for ESP-LXME and ESP-LX Basic Controller



ESP-LX Basic Controller

ESP-LXME Controllers

Modular - Easily expandable from 8 or 12 stations to 48 stations with 4-, 8-, and 12-station modules



Features

- Plastic, locking, UV resistant, wall-mount case , Optional Metal and Stainless Steel Case & Pedestal
- 8- or 12-stations base unit expandable to 48 stations with 4-, 8- and 12-Station Modules
- Flow Smart Module™ factory installed or field upgradable
- Hot-swappable modules, no need to power down the controller to add/remove modules
- Dynamic station numbering eliminates station numbering gaps
- Weather Sensor input with override switch
- Master valve/pump start circuit
- 6 user-selectable languages
- Non-Volatile (100-year) program memory
- Standard 10kV surge protection
- Front panel is removable and programmable under battery power
- Compatible with Rain Bird Landscape Irrigation and Maintenance Remote

Water Management Features

- Optional Flow Smart Module™ with Learn Flow utility and flow usage totalizer
- FloWatch™ protection for high and low flow conditions with user defined reactions
- FloManager™ manages hydraulic demand, making full use of available water to shorten total watering time
- SimulStations™ are programmable to allow up to 5 stations to operate at the same time
- Station sequencing by station numbers or station priorities
- Water Windows by program plus Manual MV Water Window
- Cycle+Soak™ by station
- Rain Delay
- 365-Day Calendar Day Off
- Programmable Station Delay by program
- Normally Open or Closed Master Valve programmable by station
- Weather Sensor programmable by station to prevent or pause watering
- Program Seasonal Adjust
- Global Monthly Seasonal Adjust

Operating Specifications

- Station timing: 0 min to 12 hrs
- Seasonal Adjust; 0% to 300% (16 hrs maximum station run time)
- 4 independent programs (ABCD)
- ABCD programs can overlap
- 8 start times per program

- Program Day Cycles include Custom days of the week, Odd, Odd31, Even, & Cyclical dates
- Manual station, program, test program

Electrical Specifications

- Input required: 120 VAC \pm 10%, 60Hz (International models: 230 VAC \pm 10%, 50Hz; Australian models: 240 VAC \pm 10%,50Hz)
- Output: 26.5 VAC 1.9A
- Power back-up: Lithium coin-cell battery maintains time and date while nonvolatile memory maintains the programming
- Multi-valve capacity: Maximum five 24 VAC, 7VA solenoid valves simultaneous operation including the master valve, maximum two solenoid valves per station
- Certifications: UL, cUL, CE, CSA, C-Tick, FCC Part 15

Dimensions

- Width: 14.32 in. (36,4 cm)
- Height: 12.69 in. (32,2 cm)
- Depth: 5.50 in. (14,0 cm)

Models

- ESP8LXME: 8-Station Controller, 120VAC
- ESP12LXMEF: 12-Station Controller with Flow Smart Module, 120VAC
- FSMLXME: Flow Smart Module for ESPLXME Controller
- ESPLXMSM4: 4-Station Module for ESP-LXME Controller
- ESPLXMSM8: 8-Station Module for ESP-LXME Controller
- ESPLXMSM12: 12-Station Module for ESP-LXME Controller
- ESPLXMEFP: ESPLXME Controller Front Panel Only

Optional Accessories

- LIMR-Kit: LIMR remote control Kit for Rain Bird Controllers (see page 89)
- Painted Metal and Stainless Steel Pedestal/Enclosure Options available (see page 95)
- ETC-LX: ET Manager Cartridge (see page 88)
- IQ Communication Cartridge (see page 99)
- Rain Bird FS-Series Flow Sensors (see page 91)



ESP-LXME Controller

ESP-LXD Decoder Controller

50 – 200 station capable Two-Wire Decoder Commercial Controller



Controller Features

- Plastic, locking, UV resistant, wall-mount case, Optional Metal and Stainless Steel Case & Pedestal
- Uses the same decoder hardware as MDC, MDC2 and SiteControl
- Supported decoders: FD-101TURF, FD-102TURF, FD-202TURF, FD-401TURF, FD-601TURF
- Also supports SD-210TURF sensor decoders (flow sensing and weather sensor support) and LSP-1 line surge protectors (one per 500 feet of two-wire path required)
- 50-station capability standard expandable to 200 stations with optional ESPLXD-SM75 modules
- Four sensor inputs (one wired plus up to three decoder-managed) with override switch
- Program backup and barcode decoder address entry with the optional PBC-LXD
- Six user-selectable languages
- Removable front panel is programmable under battery power
- Central Control capable with Rain Bird IQ v2.0 Communications Cartridges and software
- Compatible with Rain Bird Landscape Irrigation and Maintenance Remote - Flow Smart Module™ factory installed or field upgradable
- Advanced Features From Cycle+Soak™ to Contractor Default Program™, the ESP-LXD offers innovative features proven to cut installation expenses, troubleshooting time and water use

Operating Specifications

- Station timing: 0 min to 12 hrs
- Program level and global Monthly Seasonal Adjust; 0% to 300% (16 hrs maximum station run time)
- 4 independent programs (ABCD); ABC programs stack, ABCD overlap
- 8 start times per program
- Program Day Cycles include Custom days of the week, Odd, Odd no 31st, Even, and Cyclical dates
- Manual station, program, test program
- Certifications: UL, CE, CUL, C-Tick

Upgrade Options

- LXMM metal wall-mount case
- LXMM-PED metal pedestal
- ETC-LX ET Manager Smart Controller Cartridge
- IQ-NCC Network Communication Cartridge
- ESP-LXD-SM75 75-station module
- PBC-LXD Programming Backup Cartridge

Electrical Specifications

- Input required: 120 VAC ± 10%, 60Hz (International models: 230 VAC ± 10%, 50Hz; Australian Models: 240 VAC ± 10%, 50Hz)
- Power back-up: Lithium coin-cell battery maintains time and date while nonvolatile memory maintains the schedule
- Multi-valve station capacity: up to 2 solenoid valves per station; simultaneous operation of up to eight solenoids and/or master valves

Dimensions (W x H x D)

- 14.32" x 12.69" x 5.50" (36.4 x 32.2 x 14.0 cm)

Model

- ESP-LXD: 50-station, 120 VAC
- IESPLXD: 50-station for international markets, 230 VAC
- IESPLXDEU: 50-station for Europe, 230 VAC
- IESPLXDAU: 50-station for Australia, 240 VAC

Optional Accessories

- ESPLXD-SM75: 75-station module for ESP-LXD
- PBC-LXD: Program Backup Cartridge for ESP-LXD
- LIMR-KIT: LIMR remote control kit for Rain Bird controllers (see pg. 89)
- FD-TURF: two-wire decoders (see pg. 87)
- SD-210TURF: two-wire sensor decoder (see pg. 87)
- LSP1TURF: two-wire line surge protection (see pg. 87)
- DPU-210: two-wire decoder programming unit (see pg. 88)
- Painted Metal and Stainless Steel Pedestal/Enclosure Options available (see pg. 95)
- ETC-LX: ET Manager™ Cartridge for ESP-LX series controllers (see page 88)
- IQ-NCC: Network Communication Cartridge for ESP-LX Series Controllers (see page 99)
- See page 91 for information on Rain Bird FS-Series Flow Sensors

¹FD-TURF decoders include peel-off barcode address labels

²Barcode scanning pen not included – sold separately; Unitech MS100-2 recommended (www.ute.com)



ESP-LXD Decoder Controller

FD-TURF Two-Wire Decoders

SiteControl and ESP-LXD with Support for 1, 2, 4 or 6 Decoder Addresses

Features

- Select different two-wire decoders to operate one, two, four, or six valves. Five different decoder options let you choose the precise amount of landscape irrigation control you need
- Easy, cost-effective installation, expansion and upgrade between ESP-LXD and/or SiteControl systems
- Installed out of sight and protected from the elements and vandalism
- Enables advanced diagnostic and sensor features

Specifications

- **Mounting:** In valve box (recommended) or direct burial
- **Power Draw:**
 - FD-101TURF: 0.5 mA (idle) 18 mA (per active solenoid)
 - FD-102TURF: 0.5 mA (idle) 18 mA (per active solenoid)
 - FD-202TURF: 1 mA (idle) 18 mA (per active solenoid)
 - FD-401TURF: 1 mA (idle) 18 mA (per active solenoid)
 - FD-601TURF: 1 mA (idle) 18 mA (per active solenoid)
- **Dimensions:**
 - FD-101TURF: Length: 2.77 in. (70 mm), Diameter: 1.5 in. (40 mm)
 - FD-102TURF: Length: 3.35 in. (85 mm), Diameter: 1.77 in. (45 mm)
 - FD-202TURF: Length: 3.35 in. (85 mm), Diameter: 1.97 in. (50 mm)
 - FD-401TURF: Length: 3.94 in. (100 mm), Diameter: 2.56 in. (65 mm)
 - FD-601TURF: Length: 3.94 in. (100 mm), Diameter: 2.56 in. (65 mm)
- **Solenoids:**
 - FD-101TURF: 1 with individual control
 - FD-102TURF: 1 or 2 simultaneously
 - FD-202TURF: 1 to 4 simultaneously
 - FD-401TURF: 1 to 4 with individual control
 - FD-601TURF: 1 to 6 with individual control
- **Wires:**
 - FD-101TURF: Blue to cable, white to solenoid
 - FD-102TURF: Blue to cable, white to solenoid
 - FD-202TURF: Blue to cable, white and brown to solenoids
 - FD-401TURF: Blue to cable, color-coded to solenoids
 - FD-601TURF: Blue to cable, color-coded to solenoids
- **Surge Protection: One of the following is required every 500 ft. along two-wire path (40 V, 1.5 kW transil)**
 - LSP-1 Line Surge Protector
 - FD-401TURF with built in surge protection
 - FD-601TURF with built in surge protection

Note: Minimum 10ohms resistance grounding required at controller and each surge protector

- **Input Fuse (FD-401TURF and FD-601TURF only):** 300-500 mA, thermal
- **Electrical Input:**
 - Maximum voltage: 36 Vpp
 - Maximum load:
 - FD-101TURF: 1 Rain Bird solenoid (one per address)
 - FD-102TURF: 2 Rain Bird solenoids (two per address)
 - FD-202TURF: 4 Rain Bird Solenoids (two per address)
 - FD-401TURF: 4 Rain Bird Solenoids (one per address)
 - FD-601TURF: 6 Rain Bird solenoids (one per address)
- **Decoder/Solenoid Wires:**
 - Electrical resistance: Max. 3 ohms
- **Maximum Distance Decoder/Solenoids:**
 - Cable length: 14 gauge, 456 feet
- **Wiring:** 2 x 14-gauge (1.5 mm2) solid copper, UF insulated type
- **Environment:**
 - Working range: 32° to 122° F (0° to 50° C)
 - Storage range: -4° to 158° F (-20 to 70° C)
 - Humidity: 100%

Note: Rain Bird recommends using 3M DBR/DBY waterproof connectors for all connections.
Note: FD-Series Decoders are not compatible with residential valves like the Rain Bird HV, DV, DVF, ASVF, JTV, & JTVF.

Models

- FD-101TURF: Field Decoder interfacing signal line and valve
- FD-102TURF: Field Decoder interfacing signal line and valve or one pair of valves
- FD-202TURF: Field Decoder interfacing signal line and 2 valves or 2 pair of valves
- FD-401TURF: Field Decoder interfacing signal line and up to 4 individual valves
- FD-601TURF: Field Decoder interfacing signal line and up to 6 individual valves
- LSP-1TURF: Line Surge Protection
- SD-210TURF: Sensor Decoder interfacing signal line and analog or digital decoders



Decoders

DPU-210 Decoder Programming Unit

For ESP-LXD, MDC/MDC2 and SiteControl FD-Turf Two-Wire Decoders

- Decoder Programming Unit tests and verifies operation of the ESP-LXD, MDC/MDC2, or SiteControl FD Series Field Decoders. Also allows for re-programming decoder addresses for maximum site set-up flexibility



DPU-210

ET Manager™ Cartridge

Upgrades Any ESP-LX Series Controller to an ET/Weather-Based Irrigation Controller



Features

- Water Savings of 20 – 50% over traditional time based irrigation control with real-time adjustments to the irrigation schedule based on hourly weather data
- Measures the four key components of ET: solar radiation, relative humidity, wind, and temperature, as well as effective rainfall
- Four separate moisture balances are maintained. One for each program or hydrozone to efficiently water varied plant types (example: turf, shrubs, trees, annuals, etc)
- Rain interrupt to prevent irrigation during rain events
- Wind interrupt prevent overspray during high wind conditions
- Installs in seconds with no tools into all ESP-LX Series controllers snaps into a dedicated bay on the back of the controller faceplate
- The ET Manager™ Cartridge uses the Weather Reach™ signal - Eliminates the need to travel to controller sites to make adjustments or programming changes, contributing to significant labor savings
- ETC-LX kit includes ET Manager™ Cartridge, receiver antenna, manual, and ET Manager™ Resource CD which will help schedule irrigation run times based on landscape parameters

Operating Specifications

- Electrical power is provided by the LX Controller
- Operating Temperature Range 5° F-149° F (Radio reception operating temperature: 32° F - 122° F)
- Tipping Rain Gauge wire: 18 – 26 AWG

Models

- ETC-LX: ET Manager Cartridge for LX Controllers
- ETM-RMK: Remote antenna mount for ETC-LX*
- ETM-RG: Tipping Rain Gauge

** Allows the antenna to be remotely mounted for better signal reception. ET Manager™ has a built in antenna but locations with a weak paging signal may require an external antenna*

For more information call the ET Manager™ Hotline: 1-877-351-6588



ETC-LX
ET Manager™ Cartridge

Landscape Irrigation and Maintenance Remote 3.0 (LIMR)

Efficient Rain Bird irrigation system operation and head alignment

Features

- Maintaining Rain Bird system operation and head alignment is easier and faster than ever because you no longer have to walk to the clock to turn zones on or off. A single crew member can activate zones, blow out systems and perform other winterization or maintenance tasks
- Install the receiver in seconds with just one hand and operate up to 255 zones
- Skip to any zone by entering its number. No need to scroll through zones in consecutive order
- Run a system test, specifying how many minutes, which zone to start with and which zone to end with
- Two-way communication between the remote and the controller allows remote activity information to be displayed on the handheld device
- Custom names can be assigned to 20 different receivers for easy identification. Each handheld remote can control up to 128 different receivers simultaneously
- Operating range up to 1.5 miles (2.4 km) line of sight. (Operating range may be reduced when obstructions are introduced between remote system components)
- Remarkably simple interface and easy-to-follow, on-screen instructions, such as: Run a system test ,Activate a zone, Run a program , Custom receiver naming , Skip to any zone by entering its number
- Irrigation remote compatible with ESP-Me, ESP-SMTe, and ESP-RZX, ESP-SMT, ESP-LX Basic, ESP-LX, ESP-LX+, ESP-LXME, ESP-LXMEF, ESP-LXD, and ESP-LX Modular Controllers

Operating Specifications

- Electrical power is provided by the ESP-LX Series Controller
- Operating Temperature Range 5°F-149°F (Radio reception operating temperature: 32°F - 122°F)

Specifications

- Operating range: Up to 1.5 miles (2.4 Km) line of sight
- Two-way communication using FCC certified 900MHz radios
- UL Recognized
- Zone capability: 1 to 255
- Battery type: 3 – AA Alkaline
- Custom names can be assigned to 20 different receivers for easy identification
- Each handheld remote can control up to 128 different receivers simultaneously

Dimensions

- KIT: 12" (30.5cm) H x 16.75" (42.5cm) W x 2.75" (7.0cm) D
- TX: 11.2" (28.5 cm) H x 3.6" (9.3cm) W x 1.6" (4.1cm) D
- RX: 6.2" (15.8 cm) H x 4.1" (10.5cm) W x 1.22" (3.1cm) D

Models (US and Canada only)

- LIMRKIT: includes transmitter, receiver, LIMRQC603, LIMRQC503, batteries, and a durable plastic carrying case
- LIMRRX: Receiver
- LIMRQC503: 5 pin Quick Connect, 3 feet long
- LIMRQC603: 6 pin Quick Connect, 3 feet long



Landscape Irrigation and Maintenance Remote (LIMR)

TBOS-II™

Commercial Control for Battery-Powered Systems

Features

- Convenient durable option for providing uninterrupted irrigation while AC-power is not available
- Field transmitter and control module have external optical connectors for easy plug-in
- Seven advanced programming features, the TBOS-II™ cuts setup time and eliminates repeat trips to the controller, resulting in water-efficient programs and lower operating expenses
- Master Valve: Extra support for stations that require a back-up to minimize water leaks or need extra water pressure
- Basic programming includes 3 independent programs with flexible days cycles including custom even, odd, odd-31 and 1-6 day program cycles for maximum flexibility
- 8 start times per program per day and Run-time from 1 minute to 12 hours in 1-minute increments
- Independent station operation allows simultaneous start times or sequential start times based on system hydraulic capacity
- One TBOS field transmitter programs an unlimited number of TBOS Control Modules
- Field transmitter and control module have external infrared connectors for easy plug-in ESP-LXD, and ESP-LX Modular Controllers

Valve Compatibility

- TBOS potted latching solenoid is compatible with all Rain Bird valves in the DV, DVF, ASVF, PGA, PEB, PESB, GB, EFB-CP, BPE and BPES series
- The TBOS solenoid adapters will adapt the potted latching solenoid for use in retrofit applications with non-Rain Bird valves such as Irritrol® (Hardie/Richdel) and Buckner® valves or Champion® and Superior® valve actuators Tipping Rain Gauge wire: 18 – 26 awg

TBOS-II Control Module

- Available in 4 models: 1, 2, 4 and 6 stations
- Operates one valve per station
- Station timing: 1 minute to 12 hours in 1-minute increments with a 365-day calendar. Stations can be assigned to multiple programs
- Active sensor connection accommodates Rain Bird® RSD-BEX Rain Sensor
- Operates with only one 9V alkaline battery (Energizer™ and Duracell™ are recommended) type 6AM6 (international standard) or 6LR61 (European standard): battery not included
- Battery life is one year with a high-quality 9V alkaline battery
- IP-68 rated waterproof case for reliable operation under water
- Dimensions: 3.8 x 5.1 x 2 inches (9.5 x 13.0 x 5.3 cm)
- Weight: 17.64 ounces (500 g)
- Maximum wire run between the module and solenoid:

Wire Size	Maximum Distance
18 AWG (0.75 mm ²)	32 ft (10 m)
16 AWG (1.5 mm ²)	100 ft (30 m)

- C-Tick approved

TBOS-II Field Transmitter

- Field transmitter required for programming control module
- Dimensions: 2.8 x 6.3 x 1.2 inches (7.0 x 16.0 x 3.0 cm)
- Weight: 8.81 ounces (250 g)
- Operating temperature: 14 to 149° F (-10° to 65° C)
- C-Tick approved

TBOS Potted Latching Solenoid

- Two 18 gauge (0.75 mm²) wires are supplied: 23.6 inches (60 cm) long
- Fits Rain Bird valves: DV, DVF, ASVF, PGA, PEB, PESB, GB, EFB-CP, BPE and BPES Series
- 150 psi (10 bar) maximum operating pressure
- Dimensions: 1.4 x 2.4 x 1.5 inches (4.0 cm x 6.0 cm x 4.2 cm)

TBOS Solenoid Adapters

- Easy to install
- Black adapter for plastic valves allows the TBOS potted latching solenoid to be used with selected Irritrol (Hardie/Richel) and Buckner valves
- Brown adapter for brass valves allows the TBOS potted latching solenoid to be used with selected Champion and Superior valve actuators

Models

- TBOS-II Control Modules:
 - TBOS2CM1: 1 station control module
 - TBOS2CM2: 2 station control module
 - TBOS2CM4: 4 station control module
 - TBOS2CM6: 6 station control module
- TBOS-II Field Transmitter:
 - TBOS2FTUS: Field Transmitter (US)
 - TBOS2FTSAU: Field Transmitter (AUS)



TBOS-II Control Module and Field Transmitter



TBOS Potted Latching Solenoid and Solenoid Adapters

Flow Sensors and Transmitters

Maxicom², SiteControl, IQ, ESP-LX Series Controllers or IQ™

Features (Sensors)

- Simple six-bladed impeller design
- Designed for outdoor or underground applications
- Available in PVC, brass or stainless steel construction
- Pre-installed in tee or saddle mounted insert versions

Features (Transmitters)

- Reliable solid-state design, available with or without LCD display
- Easy-to-program, menu-driven design
- Programmable from a computer (PT322 – Maxicom and SiteControl Systems only – not required for ESP-LXMEF or ESP-LXD)
- Operates with MAXILink™ and (hard-wire) two-wire satellite systems
- Mounted in optional NEMA enclosure (PT3002 only)

Operating Specifications (Sensors)

- Accuracy: $\pm 1\%$ (full scale)
- Velocity: 1/2-30 feet (0.15 - 9.2 meters) per second depending on model
- Pressure: 400 psi (27.5 bars) (max) on metal models; 100 psi (6.9 bars) (max) on plastic models
- Temperature: 220° F (105° C) (max) on metal models; 140° F (60° C) (max) on plastic models

Operating Specifications (Transmitters)

- Input required:
 - 12-30 VDC/VAC on PT322
 - 10.5-26 VAC (12-24 VAC rec.) on PT 1502
 - 12-24 VAC/VDC on PT 3002
- Output: Pulse output
- Operating Temp: -4° F-158° F (-20° C to 70° C)
- Units: Domestic and International units available on PT3002

Dimensions

- PT322: 3.65" x 1.75" x 1.0" (93mm x 44mm x 25mm)
- PT3002: 3.78" x 3.78" x 2.21" (96mm x 96mm x 56mm)
- FS075P: 3.31" x 3.85" x 1.05" (84mm x 98mm x 27mm)
- FS100P: 3.50" x 3.94" x 1.315" (89mm x 100mm x 33mm)
- FS150P: 5.0" x 5.16" x 2.38" (127mm x 131mm x 60mm)
- FS200P: 5.63" x 5.64" x 2.88" (143mm x 143mm x 73mm)
- FS300P: 6.50" x 6.83" x 4.23" (165mm x 173mm x 107mm)
- FS400P: 7.38" x 7.83" x 5.38" (187mm x 199mm x 137mm)
- FS100B: 5.45" x 4.94" x 2.21" (138mm x 126mm x 56mm)
- FS150B: 6.5" x 5.19" x 2.5" (165mm x 132mm x 64mm)
- FS200B: 4.25" x 8.35" x 2.94" (108mm x 212mm x 75mm)
- FS350B: 7.13" x 3"(diameter) (181mm x 76mm (diameter))
- FS350SS: 7.13" x 3"(diameter) (181mm x 76mm (diameter))

Configuration

- **For (Hard Wire) Two-Wire Satellite Systems (Maxicom² and SiteControl)**, the Flow Sensor is installed with a Pulse Transmitter and a Rain Bird Pulse Decoder (DECPULLR)
- **For Link Radio Satellite Systems (Maxicom² and SiteControl)**, the Flow Sensor is installed with a Pulse Transmitter (no pulse decoder required)
- **For ESP-SITE Satellite Systems (Maxicom²)**, the Flow Sensor is installed with a Pulse Transmitter (no decoder required)
- **For SiteControl Decoder Systems**, the Flow Sensor is installed with a Two-Wire Decoder Sensor Decoder (SD210TURF)
- **For ESP-LXD Decoder Systems**, the Flow Sensor is installed with a Two-Wire Decoder Sensor Decoder (SD210TURF)
- **For ESP-LXMEF Systems**, the Flow Sensor is attached to the FSM-LXME Flow Smart Module
- Surge protection (FSSURGEKIT) is recommended for Maxicom & SiteControl systems – One at the Pulse Transmitter, and if more than 50' of wire run, one at the Flow Sensor. FSSURGEKIT is not compatible with ESP-LXMEF and ESP-LXD Controllers



Flow Sensors



Flow Sensor Transmitters and Accessories



Flow Sensors and Transmitters (cont.)

Models

Brass TEE's

- FS200B: 2" (50mm) Brass Tee Flow Sensor
- FS150B: 1 1/2" (40mm) Brass Tee Flow Sensor
- FS100B: 1" (25mm) Brass Tee Flow Sensor

Plastic TEE's

- FS400P: 4" (110mm) PVC Tee Flow Sensor
- FS300P: 3" (75mm) PVC Tee Flow Sensor
- FS200P: 2" (50mm) PVC Tee Flow Sensor
- FS150P: 1 1/2" (40mm) PVC Tee Flow Sensor
- FS100P: 1" (25mm) PVC Tee Flow Sensor
- FS075P: 3/4" (20mm) PVC Tee Flow Sensor

Inserts

- FS350SS: 3" and higher, Stainless Steel Insert
- FS350B: 3" and higher, Brass Insert
- FSTINSERT: Replacement insert for Tee type sensors

Pulse Transmitters (not necessary with LX Controllers)

- PT322: Pulse Transmitter, no display
- PT3002: Pulse Transmitter, LCD display
- PT322SW: PT322 Pulse Transmitter programming software

Accessories

- PTPWRSUPP: Pulse Transmitter power supply
- NEMACAB: NEMA Enclosure for PT3002
- FSSURGEKIT: Flow Sensor surge protection kit
- DECPULLR: Pulse Decoder for two-wire satellites
- SD210TURF: Sensor Decoder for decoder systems
- FSM-LXME: Flow Smart Module for ESP-LXME Series Controllers

Rain Bird Flow Sensor Suggested Operating Range

The following tables indicate the suggested flow range for Rain Bird Flow Sensors. Rain Bird Sensors will operate both above and below the indicated flow rates. However, good design practice dictates the use of this range for best performance. Sensors should be sized for flow rather than pipe size.

Model	Suggested Operating Range (Gallons / Minute)	Suggested Operating Range (Liters / Minute)	Suggested Operating Range (Cubic Meters / Hour)
FS050P	1.9 - 18.9	7.2 - 71.7	0.43 - 4.3
FS075P	3.3 - 33.2	12.6 - 125.8	0.75 - 7.5
FS100P	5.4 - 53.9	20.4 - 204	1.2 - 12.2
FS150P	5 - 100	18 - 378	1.1 - 22.7
FS200P	10 - 200	36 - 756	2.3 - 45.4
FS300P	20 - 300	78 - 1134	4.5 - 68.1
FS400P	40 - 500	150 - 1890	9.1 - 113.6
FS100B	2 - 40	6 - 150	0.5 - 9
FS150B	2 - 82.6	6.3 - 313	0.4 - 18.7
FS200B	4.9 - 294	18.5 - 1112	1.1 - 66.7
FS350B	Depends on Pipe Type and Size - please reference Flow Sensors tech spec (D37137F)		
FS350SS			

RSD-BEx / RSD-CEx

Wired Rain Sensor

Features and Benefits

- Automatic rain shutoff prevents overwatering due to natural precipitation
- Robust, reliable design reduces service call backs
- Moisture sensing disks work in a variety of climates
- Different sensor mounts permit speed and flexibility on the job site
- Latching hinge maintains alignment

Mechanical Properties

- Multiple rainfall settings from 1/8" - 3/4" (5 - 20 mm) are quick and easy with just the twist of a dial
- Adjustable vent ring helps control drying time
- High-grade, UV resistant polymer body resists the elements
- Available in rugged bracket version (RSD-BEx model comes with 5" latching aluminum bracket) or conduit version (RSD-CEx) for a clean and professional look
- Not compatible with ESP-SMT or ESP-SMTe controllers

Electrical Specifications

- Application: Suitable for low voltage 24 VAC control circuits and 24 VAC pump start relay circuits*
- Switch electrical rating: 3A @ 125/250 VAC
- Capacity: Electrical rating suitable for use with up to ten 24 VAC, 7 VA solenoid valves per station, plus one master valve
- Wire: 25' (7.6 m) length of #20, 2 conductor UV resistant extension wire
- UL, cUL listed; CE, C-Tick approved

* Not recommended for use with high voltage pump start, pump start relay circuits or devices.

Dimensions

- RSD-BEx
 - Overall length: 6.5" (16.5 cm)
 - Overall height: 5.4" (13.7 cm)
 - Bracket hole pattern: 1.25" (3.2 cm)
- RSD-CEx
 - Overall length: 3" (7.6 cm)
 - Overall height: 2.75" (7 cm)

Models

- RSD-BEx: Rain sensor w/ latching bracket, extension wire
- RSD-CEx: Rain sensor w/ threaded adapter, extension wire



How To Specify

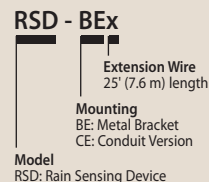

WR2 Series Wireless Rain/Freeze Sensors



Superior responsiveness to rainfall and cold temperatures, save up to 35% on water usage

Features & Benefits

- Enhanced antenna array provides superior signal reliability that overcomes most line-of-sight obstructions
- Sensor signal strength indicator enables one person set up, reducing installation time
- Convenient adjustment and monitoring of rain or freeze settings at the controller interface
- Simple battery replacement requiring no tools or need to disassemble sensor
- Highly intuitive icon-driven controller interface simplifies programming
- Easy to install, self-leveling sensor bracket mounts to flat surfaces or rain gutters
- Antennas concealed within the units for greater visual appeal and product robustness
- "Quick Shut Off" interrupts active irrigation cycle during a rain event

Electrical Specifications

- Application: suitable for use with 24 VAC controllers (with or without pump start / master valve)
- Electrical rating suitable for use with up to six 24VAC 7VA solenoids plus an additional master valve or pump start that does not exceed 53VA
- Controller Interface Wire: 30" (76 cm) length of #22 gauge (0.64 mm) UV resistant extension wire
- Certifications: UL, cUL, CE, C-Tick, and WEEE
- FCC approved spread spectrum 2 way radio transceivers with FCC Class B approvals
- Signal transmission distance of 700' Line of Sight
- Battery life: four or more years under normal operating conditions
- 6 KV surge / lightning protection

Mechanical Properties

- Adjustable rainfall settings from 1/8" – 1/2" (3 – 13 mm)
- Adjustable low temperature settings from 33°F – 41°F (0.5° – 5°C)
- Three irrigation modes to select: Programmed, Suspend Irrigation for 72 hours, Override sensor for 72 hours
- "Quick Shut Off" suspends active irrigation cycle within approximately two minutes
- High-grade, UV resistant polymer units resist harmful environmental affects

Replacement or Spare Parts

- WR2 Battery - #651009S
- WR2 Disk Assembly - #637810S

Models

- North America (916 MHz)
 - WR2-RC: Rain Combo
 - WR2-RFC: Rain/Freeze Combo
 - WR2-RFI: Rain/Freeze Controller Interface Only
 - WR2-RFS: Rain/Freeze Sensor Only
- International (868 MHz)
 - WR2-RFC-868: Rain/Freeze Combo



Controllers

Step 1



Program in seconds

Step 2



Determine best sensor location

Step 3



Install sensor easily using mounting bracket

SMRT-Y Soil Moisture Sensor Kit

Accurate • Reliable • Smart

Features and Benefits

- Turns any controller into a water saving smart controller
- Healthier landscapes less prone to nutrient depletion, fungus and shallow root growth
- Typical water savings exceed 40%
- TDT digital sensor enables highly accurate readings that are independent of soil temperature and electrical conductivity (EC)
- Displays soil moisture content, soil temperature and EC
- Corrosion-resistant in-ground sensor made of high-grade 304 stainless steel

Operating Specifications

- 25 Volts AC at 12W
- Operating temperature: -4°F to 158°F (-20°C to 70°C)
- Survival temperature: -40°F to 185°F (-40°C to 85°C)
- Certifications: UL, CUL, C-TICK

Dimensions

- **Sensor Control**
 - Width: 3.0" (76mm); H: 3.0" (76mm); D: 0.75" (19mm)
- **In-Ground Soil Moisture Sensor** (without wires)
 - W: 2.0" (50mm); L: 8.0" (200mm); D: 0.5" (12mm)

SMRT-Y Kit

- **Includes**
 - Controller User Interface
 - In-Ground Soil Moisture Sensor
 - Anodized, rust-proof screws, 1.5" (two per package)
 - Wire nuts – 5 blue, 2 gray, 1 yellow
 - Multilingual instruction manual, "Quick Start" Guide and Soil Moisture sticker

Models

- SMRT-Y: Soil Moisture Sensor Kit
- SMRT-YI: International Soil Moisture Sensor Kit

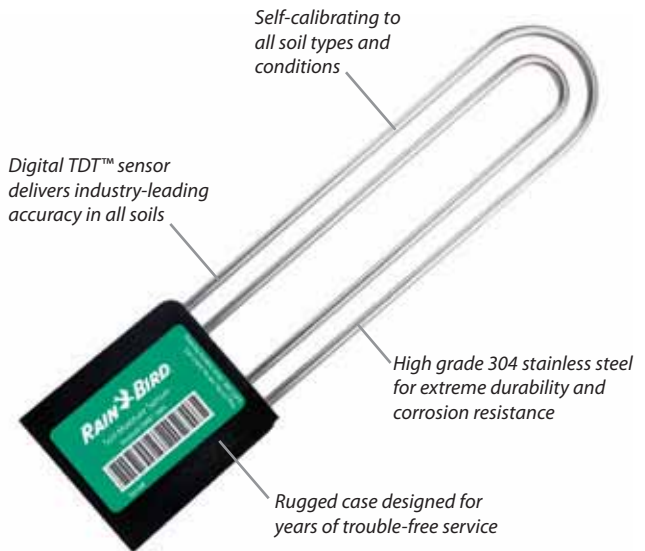

Sensor

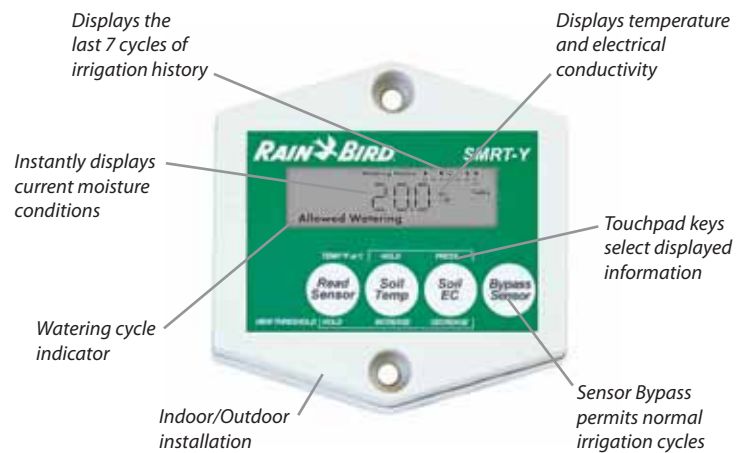

Controller

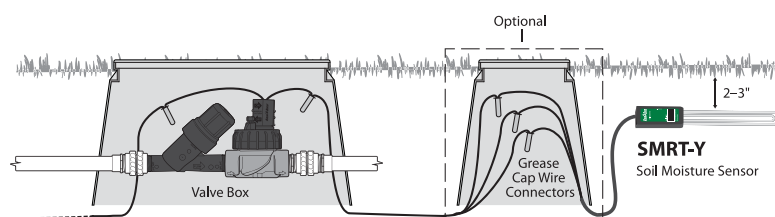
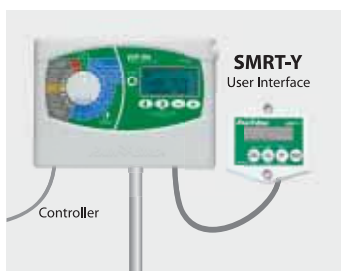

Controller Accessories

PBC-LXD Programming Backup Cartridge for ESP-LXD, Controller Pedestals, Pigtail

PBC-LXD Programming Backup Cartridge for ESP-LXD

Provides program backup and restore and barcode scanning capability for the ESP-LXD controller

Upgrade Kit Features

- Provides 8 full backups, including all programs, flow information and decoder addresses – allows you to easily archive 8 different controllers – restoring all information typically takes two minutes or less
- Snaps into the back of the ESP-LXD front panel; installs without tools; no additional enclosures or external wiring required
- Kit includes cable for interface to barcode scanning pen (pen not included) – allows you to quickly scan decoder addresses into the ESP-LXD controller during installation to save you time

Model

- PBC-LXD (works with all versions of the ESP-LXD controller)



PBC-LXD Cartridge

Pigtail

Features

- 6-feet (1.8 m) long
- Three 16 gauge stranded conductor wires
- 90 degree molded plug type NEMA 5-15P
- Gray color

Model

- PIGTAIL



PIGTAIL

Controller Pedestals

Pedestals for ESP-LX Series, ESP-MC, ESP-SAT, ESP-SITE, and CCU

Features

- Includes all necessary mounting bolts, nuts, and washers

Specifications

- Material: Powder-coated steel and stainless steel
- Field wiring connection: In controller

Dimensions

Model	Height	Width	Depth
• PED-DD16	23½" (59.7 cm)	10½" (26.7 cm)	5" (12.7 cm)
• LXMM	12⅞" (32.7 cm)	14½" (36.8 cm)	7¾" (19.7 cm)
• LXMMPED	28" (71.1 cm)	14¼" (36.2 cm)	7¼" (18.4 cm)
• LXMMSS	12⅞" (32.7 cm)	14½" (36.8 cm)	7¾" (19.7 cm)
• LXMMSSPED	28" (71.1 cm)	14¼" (36.2 cm)	7¼" (18.4 cm)

Model

- PED-DD16: Pedestal for ESP-SAT, ESP-SITE, and CCU
- LXMM: Metal Cabinet for ESP-LX Series Controllers*
- LXMMPED: Metal Pedestal for ESP-LX Series Controllers*
- LXMMSS: Stainless Steel Metal Wall Mount Enclosure for ESP-LX Series Controllers
- LXMMSSPED: Stainless Steel Metal Pedestal for ESP-LX Series Controllers*

* **Note:** Metal cabinets and pedestals are not standard on ESP-LX Series controllers and must be purchased separately. LXMMPED requires LXMM, and LXMMSSPED requires LXMMSS.



PED-DD16 Shown with ESP-12 SAT-2W



LXMMPED Shown with ESP-LXME in LXMM Metal Cabinet

Central Controls

Introduction

Spray/Bodies

Spray Nozzles

Rotors

Valves

Controllers

Central Controls

Landscape Drip

Pumps

Drainage & Accessories

Resources



"We recommend Maxicom²® to our clients because the system is the most efficient and effective method for controlling individual zones within complex irrigation systems. Maxicom² analyzes weather conditions from the previous 24 hours and adjusts the amount of water needed for the conditions and for each specific zone. Our clients reap the benefits – lower costs for labor and water, plus healthier plants and turf."

*Ellen Beighley, President
Irrigation Management Systems*



Water Saving Tips

- Maxicom², SiteControl, and IQ™ Systems provide fully-automated ET (evapotranspiration) adjustment of irrigation programs for maximum water savings.
- Maxicom² and IQ™ Systems provide the tools to efficiently water dozens or even hundreds of irrigation systems across multiple remote sites from a single computer.
- Maxicom² and IQ™ FloWatch™ utility monitors and records real-time flow and automatically diagnoses and eliminates flow problems caused by broken pipes, vandalism or stuck valves.

Major Products			
System Name	IQ™ v2.0	SiteControl	Maxicom®
System Type	Modular multi-site central control system	Modular single site central control system	Multi-satellite central control system
Traditionally wired or two-wire decoder	Works with both	Works with both	Traditionally wired
Typical applications	Multi-site management with modular features. Ideal solution for water managers, schools, parks, corporate campuses and transportation departments	Single site management with modular features. Ideal for large resorts, cemeteries, shopping centers, theme parks and sports stadiums	Multi-site commercial or industrial irrigation applications. Ideal for municipalities, school districts, homeowner associations and park and recreation departments
Number of sites/system	999	1	200+
Local and/or remote site control	Local and remote	Local	Local and remote
Upgradeable to central control	N/A	N/A	N/A
Maximum number of simultaneous stations per site/system	5 per ESP-LXME 8 per ESP-LXD	3,584 per site	112 per CCU
Number of ET (weather) sources	100	4	16
Program adjustments by ET	Yes	Yes with optional Automatic ET Software Module	Yes
Program adjustments by percentage	Yes	Yes	Yes
Programming by volume/gallons	No	No	Yes
Number of programs	4 per satellite	100 total per system	999 per CCU
Flow management capabilities	Yes	Yes	Yes
Flow monitoring/recording capabilities	Yes	Yes	Yes
High-flow shutdown	Mainline and laterals	Mainline only	Mainline and laterals
Low- or zero-flow shutdown	Mainline and laterals	No	Mainline and laterals
Alarms/warnings	Yes	Yes	Yes
Sensor input and manual bypass	Yes	Yes	Yes
Number of weather sensor inputs	One per ESP-LXME Four per ESP-LXD	Up to 200 sensor inputs per system	Up to 56 per CCU
Number of flow sensor inputs	One per ESP-LXMEF Five per ESP-LXD	Up to 200 sensor inputs per system	Up to 6 (two wire) or 20 (Link) per CCU
Software/password log-on protection	Yes	N/A	Yes
Remote control capabilities	Yes, LIMR Remote	Yes, Freedom System	Yes, Freedom System
Cycle+Soak™	Yes	Yes	Yes
Water window by program/schedule	Yes	Yes	Yes
Computer included with software	No	Yes	Yes
Computer programming	Yes	Yes	Yes
24/7 system monitoring	No	Yes, by the computer	Yes, by the CCU
24/7 communication & feedback	No	Yes, computer to satellites and decoders	CCU to satellite
Remote site telephone, cellular, radio, Ethernet, Wi-Fi communication	All	No	All
Automatic remote site communication	Yes	No	Yes
Satellite controllers or decoders	ESP-LXME or ESP-LXD Satellites	ESP-SAT Satellites or FD-Series Decoders	ESP-SAT or ESP-SITE Satellites
Modular station capacity	ESP-LXME: 8-48 ESP-LXD: 50-200	No	No
Number of site/system interfaces	N/A – No interfaces required	8	>200
Number of satellites/system	16,000+	896	>5,600
Number of satellites/site interface	Up to 150 satellites per IQNet	Up to 112 per TWI	Up to 28 per CCU
Number of satellite stations/site	ESP-LXME: Up to 7,200 per IQNet ESP-LXD: Up to 30,000 per IQNet	Up to 21,504 per system	Up to 672 per CCU
Number of decoder addresses per site	Up to 30,000 per IQNet	Up to 4,000	N/A
Spreadsheet style interface	Yes	Yes	Yes
Interactive map interface	No	Yes	No
GPS, CAD, SHP, BMP Import	N/A	Yes	BMP, PDF, JPEG
Valve control: stations or decoders	Both	Both	Satellite stations only
Estimated/actual water use report	Yes	Yes	Yes
Event recording (station operation)	Yes	Yes	Yes
Projected operation (dry/run) capability	Yes	Yes	Yes
Supported by Global Services Plan	Yes	Yes	Yes
Can also manage lighting and security systems	Yes	Yes	Yes

IQ™ v2.0 Central Control Software

Modular Multi-Site Central Control

Features

- Perfect irrigation control solution for parks departments, school districts, property managers, landscape maintenance contractors, and water managers
- IQ can manage small single-controller sites as well as large multi-controller sites and supports both ESP-LX Series Traditionally Wired and 2-Wire Decoder controllers
- IQ Software provides 5-satellite controller capacity that can be upgraded in 5-satellite increments with IQ5SATSWU upgrade to any total satellite capacity required
- IQ Software includes a context-sensitive help system. Click on the help icon available in most screens and be taken directly to the help topic feature you are using. The software offers multiple language, date/time, and units support allowing the user to interface with the software in their primary language. User selectable languages include English, Spanish, French, German, Italian, and Portuguese
- Site, satellite, and station names
- Programming in seconds, minutes, and hours
- Daily or Monthly Seasonal Adjust % or ET station run time adjustments by site
- Dry-Run™ Graphical Program Review
- User initiated Synchronize and Retrieve Logs communication
- Manual Program, Test Program, Station starts
- Detailed logs and reports
- Satellite PIN-Code Protection (4-digit PIN-Code required to make programming changes at the satellite)
- Satellite 2-Way Programming (changes made at the satellite can be viewed and accepted in the IQ software)
- Copy/Move Satellite Utility (copy or move a satellite to another site)
- Automated satellite Synchronize & Retrieve Logs and Weather Source Retrieve Weather Data communication
- Satellite IQ Call-in™ (satellite initiates communication, NCC-PH Phone Cartridge only)
- Automated Email Alarm/Warning and Satellite Station Run Time Reports

- Retrieves minute-by-minute flow logs from flow sensor-equipped ESP-LXMEF and ESP-LXD Satellite Controllers
- Flow Logs vs. Projected Flow Graphical Report (identifies which programs & stations were running at any point in time)
- Actual Flow Totals added to Satellite Station Run Time Report (included in Automated Email Reports)
- Automated MAD (Management Allowed Depletion) Irrigation Scheduling adjustments
- Software uses Irrigation Association terminology and formulas
- ET/Rainfall Weather Sources include: CIMIS Internet Service (California only), ETMI ET Manager Weather Reach Service (North America only), Rain Bird® WS-PRO LT Weather Station, Rain Bird® WS-PRO2 Weather Station
- 4 ET Checkbooks per satellite controller
- Export to Microsoft Excel® for customized reports

Options

- Additional 5-Satellite Upgrade is added through a purchased software activation keycode Increases IQ Software satellite controller capacity by 5-satellites for each upgrade purchased
- NCC Network Communication Cartridges upgrade ESP-LX Series standalone controllers to IQ v2.0 satellite controllers



IQ v2.0 Software

How To Specify

IQ V2.0 SOFTWARE

- IQADVCECD: 5-Satellite Capacity with 4 advanced feature packs included
- IQ5SATSWU: Software 5-Satellite Capacity Upgrade

IQ NCC Network Communication Cartridge

Upgrades any ESP-LX Series Controller to an IQ Central Control Satellite Controller

Features

- IQ is the perfect irrigation control solution for parks departments, school districts, property managers, landscape maintenance contractors and water managers. IQ can manage small single-controller sites as well as large multi-controller sites. IQ NCC cartridges are compatible with the ESP-LXME Controller with 1- to 48-station capacity and ESP-LXD Decoder Controller with 1- to 200-station capacity
- IQ NCC cartridges are initially configured through a setup wizard provided in the ESP-LX Series Controller IQ Settings dial position. Communication setting parameters are configured through the IQ software or the NCC Configurator Software designed for netbook/laptop use on the job site

Direct Satellites

- Single controller sites would use an IQ NCC cartridge configured as a Direct satellite. A Direct satellite has an IQ central computer communication connection but no network connections to other satellites in the system

Server & Client Satellites

- Multi-controller sites would use one IQ NCC cartridge configured as a Server satellite and the other NCC cartridges configured as Client satellites. The Server satellite has an IQ central computer communication connection and shares this communication connection with the Client satellites through high-speed data cable or radios. The communication connection between Server and Client satellites is called the IQNet™
- Satellites on a common IQNet can share weather sensors and master valves
- Server and Client satellites using high-speed data cable for IQNet communication require installation of an IQ CM Communication Module. Server and Client satellites using radio communication for IQNet communication require installation of an IQSSRADIO radio. Each cartridge kit includes cables to connect the NCC cartridge to connection module and/or radio

IQ NCC-PH Phone Cartridge

- Includes embedded 56K Telco Analog Phone Modem with RJ-11 port
- Includes RJ-11 modular phone cable (analog phone line required)

IQ NCC-GP GPRS/Cellular Cartridge

- Includes embedded GPRS/Cellular Data Modem with antenna connector
- Includes internal antenna for plastic controller enclosures (optional external antenna available for metal case controller enclosures)
- Requires GPRS/Cellular data service plan with static IP address from Cellular Service Provider
- Available with 1st year of communication service included. Cartridge with included communication service not offered in all areas

NOTE: Wireless communication devices require a wireless site survey
(Models: IQNCC-GP, IQNCCWF, IQSSRADIO)

IQ NCC-EN Ethernet Cartridge

- Includes embedded Ethernet Network Modem with RJ-45 port
- Includes RJ-45e patch cable (requires LAN network static IP address)

IQ NCC-WF WiFi Cartridge

- Includes embedded WiFi Wireless Network Modem with antenna connector, and internal antenna for plastic controller enclosures (requires LAN wireless network static IP address; optional external antenna available for metal case controller enclosures)
- WPA/WPA2 encryption supported

IQ NCC-RS RS232 Cartridge

- Includes RS-232 Port for IQ Direct Cable or External Modem communication connection to the IQ central computer, and external modem cable (IQ Direct Cable provided with IQ Software Package)
- Used for Direct or Server Satellite applications requiring direct cable connection or external modem (radio or other 3rd-party device) communication with the IQ central computer, and for Client Satellite applications requiring IQNet high-speed data cable or radio communication with the Server Satellite

IQ FSCM-LXME Flow Smart Connection Module

- Provides IQNet high-speed data cable connections for ESP-LXME Controller
- Includes Flow Smart Module and Base Module functions
- Replaces standard ESP-LXME Base Module

IQ CM-LXD Connection Module

- Provides IQNet high-speed data cable connections for ESP-LXD Controller
- Installs in ESP-LXD 0 (zero) module slot

IQ SS-Radio Radio Modem

- Provides IQNet wireless radio communication between Server and Client satellite controllers
- Can also be used with the IQ NCC-RS RS232 Cartridge for IQ central computer to Direct or Server satellite radio communication
- Includes power supply and external antenna (programming software and cable provided separately)



IQ NCC Network
Communication Cartridge

SiteControl

A Full-Featured Central Control System for Single Site Applications

Features

- Advanced Graphical Tracking- Maps generated by GPS technology or AutoCAD recreate your site. Interactive mapping and on-screen graphics show your complete site with location of individual valves and sprinklers allows you to measure and calculate areas from your map
- Smart Weather™ is designed to take complete advantage of Rain Bird's most advanced line of weather stations, tracks ET and rainfall via a weather station and reacts to current weather conditions based on user-defined options. Advanced warning system accepts user-defined sensor thresholds. System operator is immediately alerted if thresholds are exceeded
- RainWatch™ uses tipping bucket rain can(s) to detect and suspend irrigation while measuring rainfall. When rain stops, irrigation resumes with run times reduced according to measured rain
- Minimum ET- allows setting minimum ET threshold values for irrigation to take place. Promotes deep watering for optimum turf conditions
- Automatic ET automatically adjust run times in relation to fluctuations in Evapotranspiration (ET) values
- Remote System Control allows you to take control of your system and operate SiteControl from anywhere on your site using the Rain Bird FREEDOM System. Phone (landline or cellular) or radio communication options
- Hybrid System operates Satellite Controllers and/or Two-Wire Decoders
- SiteControl Plus operates four Large Decoder Interfaces (LDI), each capable of operating up to 1,000 solenoids with Hybrid system, can further expand capabilities by combining Two-Wire Decoder and/or Satellite Controller options up to four total interface devices

Superior Monitoring and Scheduling

- Flo-Graph™ allows visibility of real-time graphics with individual station information presented in colorful charts
- Flo-Manager™ balances system demands and maximum capacities with efficiency helping to lower water demand, reduce system wear and tear and save energy
- Cycle + Soak™. Better control the application of water on slopes and in areas with poor drainage
- QuickIRR™ Quick and easy method to build irrigation schedules and programs based on your parameters

Other Features

- Up to 200 points of connection
- Up to 200 pulse sensors
- Water usage logs
- Station run-time logs
- Posted and dry run logs
- ET spreadsheet
- 1 year Global Service Plan included

Models

- SCON: Desktop PC with SiteControl software, includes 1 year Global Support Plan (GSP)

Software Module Options

- Smart Weather
- Rain Bird Messenger (for Smart Weather)
- Automatic ET
- Hybrid Module
- Smart Sensor
- Map Utilities
- Freedom
- 8 Additional Locations
- Additional Wire-Path (2nd)
- Additional Wire-Path (3rd)
- Additional Wire-Path (4th)
- SiteControl Plus
- Smart Pump
- MI (Mobile Interface)

GSP Features

- Toll-free phone support (see page 106)
- Remote system diagnostics
- Extended warranty
- Next business day hardware replacement
- Future upgrades to SiteControl software at no charge
- Training or on-site support rebates
- Incident and other support
- Board Exchange Program discounts



SiteControl

SiteControl Hardware

TWI Satellite Interface

- Allows real-time, two-way communication between SiteControl Central Controller and field satellites
- Allows use of advanced in-field capabilities of ESP-SAT twowire or LINK versions
- Modular capacity can grow with the site

Two-Wire Decoder Interface

- Allows real-time, two-way communication between SiteControl Central Controller and decoders
- Connects the powerful capabilities of SiteControl with the ease of installation and security of a two-wire decoder system
- System can be set up and expanded according to project needs

ESP-SAT Satellite Controller

- 12, 24, 40 Stations Satellite Controller
- Field Satellite Controller for Maxicom2 or SiteControl Central Control systems
- The power of an advanced water-management tool, in an easy-to-use package
- All the features and stand-alone capabilities of the Rain Bird ESP-MC Controller line

Spread Spectrum Radio

- Frequency hopping to avoid interference
- Reduced cost of ownership, no FCC license required
- No FCC restrictions on antenna height (User should check local laws)
- Radios can be set up as repeater to achieve great distances and overcome obstacles

Ethernet Devices

- Use Ethernet networks to:
 - Communicate from Central Control Computer to CCUs, SiteSats, TWIs and weather stations
 - Communicate from CCU and TWIs to ESP-Sats

Freedom for Central Control

- Uses standard telephone interface
- Single cellular phone can control entire central control system
- Standard land-line telephones can also control system

WS-PRO Weather Stations

- Scientific accuracy sensors located three meters above the ground for added vandal-resistance
- Powerful, internal micro-logger for climatic data collection, logging and analysis, constant communication with weather sensors, and storage of 30 days of data
- Rugged yet lightweight metal construction;

Sensor-Pulse Decoders

- Complete feedback system
- Extends central control system versatility
- Color-coded wire leads for ease of installation
- Programmable address codes for individual operation

RAINGAUGE Rain Sensor

- Accurate rain counter switch counts rainfall in 1/100th inch increments
- Heavy-duty metal construction
- Mounting bracket
- Debris screen

ANEMOMETER Wind Sensor

- Accurate wind speed measurement for high-wind shutdown or interrupt of irrigation programs
- Heavy-duty metal mounting bracket
- Requires PT322 or PT3002 Pulse Transmitter for use with Maxicom² System

Maxi Interface Boards

- Upgrades an ESP-MC Controller (wall mount or pedestal) to an ESP-SAT or ESP-SITE Satellite Controller
- No additional enclosures or external wiring required
- Installs on stand-offs on controller output board

MSP-1 Surge Protection

- Protects central control components from electrical surges on a two-wire communication path
- Can be installed in satellite or CCU pedestal or in valve box in conjunction with MGP-1 (Maxicom²® Grounding Plate)

MGP-1 Surge Grounding Plate

- Provides a mounting location for MSP-1 or other grounding wires directly to a grounding rod or pipe
- Installed on grounding rod or pipe

Maxicom²®

Multi-Site Central Control Ideal for Large Commercial Systems



System Features

- Maxicom² Central Controller Package comes with Maxicom² software, pre-configured computer, Global Service Plan (GSP), and training
- Control hundreds of ESP-SITE-SAT Satellites (single controller sites) and Cluster Control Units (CCUs) which can each control up to 28 individual ESP-SAT Satellite Controllers on multi-controller sites
- Monitor dozens of Weather Sources including WSPRO2 Weather Stations, ET Managers, or rain counting sensors (Raingauge)
- Freedom Remote Control allows manual operation of system through a cellular phone or radio
- Multiple log and water usage reports are generated automatically to track system operation and water savings

Water Management Features

- Cross satellite schedule operation; 999 separate schedules per CCU provides precision watering of areas and microclimates
- ET Checkbook™ manages Evapotranspiration (ET) and automatically adjusts Satellite Controller station run-time or day cycle intervals to match the landscapes water requirements
- FloManager™ manages the total flow demand placed on the water source(s), optimizing both the available water and watering window
- FloWatch™ monitors flow sensors at each water source, records flow, and automatically reacts to problem flows by shutting down the effected portion of the system (individual valve or mainline)
- RainWatch™ monitors rain counting sensors, records rainfall, and automatically reacts to rainfall by interrupting irrigation, waiting to see how much rain has fallen, and determines if the irrigation should be resumed or cancelled

Operational Features

- Communication Control Engine automatically sends updated programming to sites before watering begins and retrieves logs after irrigation is completed; manual operation can be performed at any time
- Start day cycles: Custom (day of the week), Odd/Even, Odd31, or Cyclical and include Event Day Off Calendar scheduling
- Station run-times programmable from 1 minute to 16 hours
- Cycle + Soak™ optimizes water application to soil infiltration rate, reducing runoff and puddling
- Control non-irrigation functions such as lighting, fountains, door locks and gates

Maxicom² Communications Options

- Central Controller to CCU: Phone, direct connect, radio, cellular, network (Ethernet, Wi-Fi, fiber-optics)
- CCU to ESP-SAT2: Two-wire path
- CCU to ESP-SATL: Radio, MasterLink, network (Ethernet, Wi-Fi, fiber-optics)

Global Service Plan (GSP) Features (see page 106)

- Toll-free phone support
- Remote systems diagnostics
- Customer satisfaction policy on covered central control components and next business day hardware replacement
- Free software service packs
- Training and on-site support rebates
- Board Exchange Program discounts

Models

- MC2GOLD1: New System - Desktop PC with Maxicom software, includes 1 year Global Support Plan (GSP)
- GSPMCP3: Current GSP Or Expired GSP Subscribers, Desktop PC with Maxicom software, includes 3 Years Platinum Plus Global Support Plan
- GSPMXPPCIA: Current GSP Subscribers, Desktop PC with Maxicom software, based on 3 Year Platinum Plus Global Support Plan, includes year 1 GSP, requires year 2 and 3 GSP to be purchased separately (M95543A2)
- GSPMXPPCIM: Current GSP Subscribers, Desktop PC with Maxicom software, based on 3 Years Platinum Plus Global Support Plan, includes month 1 GSP, requires month 2 - 36 GSP to be purchased separately (M95544M2)
- GSPMXPPNIA: New GSP or Expired GSP Subscribers, Desktop PC with Maxicom software, based on 3 Years Platinum Plus Global Support Plan, includes year 1 GSP, requires year 2 and 3 GSP to be purchased separately (M95541A2)
- GSPMXPPNIM: New GSP or Expired GSP Subscribers, Desktop PC with Maxicom software, based on 3 Years Platinum Plus Global Support Plan, includes month 1 GSP, requires month 2 - 36 GSP to be purchased separately (M95542M2)
- MC2UPG: Maxicom Upgrade Software - CD Only, upgrade existing Maxicom 1.X, 2.X and 3.X system to latest Maxicom Version



Maxicom²

Maxicom²® Hardware

Cluster Control Unit CCU Interface

- Runs real-time operations of a site consisting of up to 28 satellites
- Adapts station sequence to changing conditions for maximum efficiency
- Instantly responds to unexpected conditions and sensor inputs

ESP-SAT Satellite Controller

- 12, 24, 40 Stations Satellite Controller
- Field Satellite Controller for Maxicom2 or SiteControl Central Control systems
- The power of an advanced water-management tool, in an easy-to-use package
- All the features and stand-alone capabilities of the Rain Bird ESP-MC Controller line

ESP-SITE-SAT Satellite Controller

- 12, 24, 40 Stations Satellite Controller
- Combines power of a Cluster Control Unit (CCU) with capabilities of a single ESP-Satellite controller for small Maxicom2 sites
- Advanced water-management tool, in an easy-to-use package
- All the features and stand-alone capabilities of the Rain Bird ESP-MC Controller line

Spread Spectrum Radio

- Frequency hopping to avoid interference
- Reduced cost of ownership, no FCC license required
- No FCC restrictions on antenna height (User should check local laws)
- Radios can be set up as repeater to achieve great distances and overcome obstacles

Ethernet Devices

- Use Ethernet networks to:
 - Communicate from Central Control Computer to CCUs, SiteSats, TWIs and weather stations
 - Communicate from CCU and TWIs to ESP-Sats

Freedom for Central Control

- Uses standard telephone interface
- Single cellular phone can control entire central control system
- Standard land-line telephones can also control system

WS-PRO Weather Stations

- Scientific accuracy sensors located three meters above the ground for added vandal-resistance
- Powerful, internal micro-logger for climatic data collection, logging and analysis, constant communication with weather sensors, and storage of 30 days of data
- Rugged yet lightweight metal construction

Sensor-Pulse Decoders

- Complete feedback system
- Extends central control system versatility
- Color-coded wire leads for ease of installation
- Programmable address codes for individual operation

RAINGAUGE Rain Sensor

- Accurate rain counter switch counts rainfall in 1/100th inch increments
- Heavy-duty metal construction
- Mounting bracket
- Debris screen

ANEMOMETER Wind Sensor

- Accurate wind speed measurement for high-wind shutdown or interrupt of irrigation programs
- Heavy-duty metal mounting bracket
- Requires PT322 or PT3002 Pulse Transmitter for use with Maxicom² System

Maxi Interface Boards

- Upgrades an ESP-MC Controller (wall mount or pedestal) to an ESP-SAT or ESP-SITE Satellite Controller
- No additional enclosures or external wiring required
- Installs on stand-offs on controller output board

MSP-1 Surge Protection

- Protects central control components from electrical surges on a two-wire communication path
- Can be installed in satellite or CCU pedestal or in valve box in conjunction with MGP-1 (Maxicom² Grounding Plate)

MGP-1 Surge Grounding Plate

- Provides a mounting location for MSP-1 or other grounding wires directly to a grounding rod or pipe
- Installed on grounding rod or pipe

WS-PRO Weather Stations

Maxicom²® (WS-PRO2 only), SiteControl, IQ™ (WS-PRO2 and WSPROLT)

Features

- Scientific accuracy sensors located three meters above the ground for added vandal-resistance
- Powerful, internal micro-logger for climatic data collection, logging and analysis, constant communication with weather sensors, and storage of 30 days of data
- Rugged yet lightweight metal construction
- Self-diagnostic test mechanisms: internal moisture, battery voltage level, test port for local sensor check, and simple-to-service sensors and internal components
- State-of-the-art weather software calculates ET values, stores daily and historic ET values, monitors and displays current weather conditions, and graphically displays weather parameters

SiteControl Features

- WS-PRO2 and WS-PRO-LT Weather Station compatibility is standard for SiteControl v3.0 or later software
- SiteControl can interface with up to 6 weather stations
- Automatic communication between Central Controller and Weather Station requires SiteControl Automatic ET Software Module
- SiteControl Smart Weather Software Module enables automatic, user defined reactions to weather events (rain, freeze, high wind, etc.)

IQ v2.0 Features

- WS- PRO2 or WS-PRO-LT Weather stations are compatible with IQ v2.0 or later software with advanced ET Feature Pack (IQAETFP)
- Automatic communication between the IQ v2.0 central and weather station requires the communication feature pack (IQACOMFP)
- Weather data retrieval hourly or custom retrieval times up to 5 per day
- IQ can interface with 100 weather stations

Maxicom²® Features (WS-PRO2 only)

- WS-PRO2 Weather Station compatibility is standard for Maxicom²® v3.6 or later software
- Each site can have its own Weather Station or can share between sites
- Automatic communication standard
- Up to 24 automatic weather data retrievals can be configured per day

Weather Station Sensors

- Air Temperature
- Solar Radiation
- Relative Humidity
- Wind Speed
- Wind Direction
- Rainfall

System Compatibility

- Maxicom² (WS-PRO2 only)
- SiteControl (requires Automatic ET Software Module)
- IQ v2.0 with Advanced ET Feature Pack
- ET Manager Weather Reach Server Software

Models

- WS-PRO2-DC Direct Connect model – 2-pair wire connection with Central Controller via short-haul modem
- WS-PRO2-PH Phone Connect model – dial-up phone modem for phone communication with Central Controller
- WS-PRO2-PHS Phone Connect, Solar Power model – dial-up phone modem for phone communication with Central Controller, solar powered
- WS-PRO-LT-SH Short Haul model – 2-pair wire connection with Central Controller via short-haul modem
- WS-PRO-LT-WL Wireless model – wireless connection with Central Controller via 916 MHz radio (only available in the U.S. and Canada)
- WS-PRO-LT-WLS Wireless model – wireless connection with Central Controller via 916 MHz radio, solar powered (only available in the U.S. and Canada)



WS-PRO
Weather Station

Spread Spectrum Radio

Maxicom², SiteControl or IQ™

Features

- Frequency hopping to avoid interference
- Reduced cost of ownership, no FCC license required
- No FCC restrictions on antenna height (User should check local laws)
- Radios can be set up as repeater to achieve great distances and overcome obstacles

Installation Requirements

- Site Survey required prior to ordering and must be submitted with order
- RADTN9MIB mounts directly onto ESP-SAT MIB; RADTN9TWI connects with ribbon cable
- Antenna and antenna cable required (sold separately by Rain Bird Production and Service Center)

Models

- **Radios – For IQ Primary & Secondary Communication and For Maxicom and Site Control Primary Communication**
 - IQSSRADIO: 900 MHz Spread Spectrum radio – Allows communication between Central Computer and IQ Direct or IQ Server Satellite, and between IQ Server Satellite and IQ Client Satellites. Also can be used for communication between Maxicom Central Computer and CCU or Site Satellite, between Site Control Central Computer and TWI / SDI or LDI, and between a Central Computer and weather station
- **Radios – For Maxicom and Site Control Secondary Communication**
 - RADTN9MIB: license free wireless radio (902-928 MHz) between CCU and satellites
 - RADTN9TWI: license free wireless radio (902-928 MHz) between TWI and satellites

ANEMOMETER Wind Sensor

Maxicom², SiteControl, IQ™, ESP-LXME, ESP-LXD

Features

- Accurate wind speed measurement for high-wind shutdown or interrupt of irrigation programs
- Heavy-duty metal mounting bracket
- Requires PT322 or PT3002 Pulse Transmitter for use with Maxicom² System
- Requires PT3002 Pulse Transmitter for use with SiteControl, IQ Systems, ESP-LXME, ESP-LXD

Model

- ANEMOMETER



ANEMOMETER

Central Control Global Service Plans

Maxicom²®, Site Control Systems, IQ and Stand Alone Controllers

Phone Only Plan / Classic Plan / Plus Plan / GSP IQ Mobile Tablet Plan

Rain Bird now has four new Global Service Plans that offer new flexibility, features, and options for customers who operate Maxicom, Site Control, or IQ2.

Phone Only Plan

- **NEW!** All plans now include **24 Hour Emergency Paging** for after hour or weekend emergencies
- **Toll-Free Central Control Support** Toll-free 8am to 5pm local business hours, Monday – Friday, normal business days. Bilingual support is also available
- **Remote System Access and Diagnostics.** GoToAssist Software allows GSP to aid you with serious issues or demonstrate answers to all your questions
- **Free Software Service Packs.** Keeps software current. Software service packs at no additional charge for new or current GSP subscribers
- **GSP's Board Exchange Program.** Receive full access to our new expanded list of commercial controller components
- **Next Business Day Circuit Board Delivery.** Fast, efficient, valuable service. Includes a six month Rain Bird Factory warranty. Ships from Rain Bird to your site. No more waiting for board repair service

Classic Plan

All of the features of the Phone Only Plan plus:

- **Additional 20% Discount** for Board Exchange
- **Next Business Day Replacement for Central Control Interfaces.** This now includes IQ2 Server Satellites, Decoder interfaces and TWIs for Site Control. CCUs and Site Sats for Maxicom systems

Plus Plan

All of the features of the Phone Only and the Classic Plan plus:

- **A 1500VA Uninterruptible Power Supply.** Receive the top of the line UPS to help protect the central control computer and all your irrigation data in case of a sudden power outages or surges
- **Ruggedized Tablet.** A WiFi and cellular capable 7.9 inch LED Multi-Touch Display tablet for control of your system from anywhere there is internet access



New! GSP IQ Mobile Tablet Plan.

The Mobile Tablet Plan includes:

- **A high-resolution 10.8" Full HD Display Tablet** with full internet connectivity via WiFi or cellular mobile broadband
- **Protective key board and an active stylus.**
- **GSP Support** (Same as the Phone Only Plan)
- **2 year accidental damage coverage through Dell**
- **IQ2006 Software included!**



Software is pre-loaded and activated for an easier startup.

PC Options Available for All Plan Levels

A Rain Bird Supplied PC is simply the best way to be assured of reliability, compatibility, warranty support, and ease of system troubleshooting by our Dell Certified GSP Engineers. Configured and built in our Production and Service Center for complete functionality with Maxicom, Site Control, and IQ2. For GSP renewals, re-enrollments, and new system sales, take advantage of Rain Bird's PC expertise to supply a key component of your system. Pricing and Specifications are available from your Rain Bird Distributor.



If you would like to know more about our Central Control Global Service Plans contact your local Rain Bird Central Control Distributor or call GSP at (866) GSP – XPRT.

How to Order

Payment Options	Commercial Central Control GSP Plans			
	Phone Only	Classic	Plus	GSP IQ Mobile Tablet Plan
Annual Payment Option:	Part Number	Part Number	Part Number	Part Number
Initial Annual Payment	C01394A	C01395A	C01396A	C01397A
Additional Years (Add 2, 3, or 4 Additional Years)	C01394A01	C01395A01	C01396A01	C01397A01
Single Payment Options:	Part Number	Part Number	Part Number	Part Number
1 Year Single Payment	C01394	C01395	—	C01397
2 Year Single Payment	C013942Y	C013952Y	—	—
3 Year Single Payment	C013943Y	C013953Y	C013963Y	C013973YR
5 Year Single Payment	C013945Y	C013955Y	C013965Y	—



"Having grown up in Tucson, saving water is my passion! I became intrigued with 'Drip-in-Turf' after seeing its success at a corporate building in Del Mar, and a College in San Diego. I wanted to experience it myself, so I retro-fitted my own backyard. My turf has an irregular shape, so overspray was a big issue. Applying water directly to the root zone worked efficiently, my turf looks great, and I'm saving water. I am now a true believer and specify 'Drip-in-Turf' whenever I can!"

Marian Marum, ASLA, LEED AP
Marum Partnership Landscape Architecture
San Diego, California



Water Saving Tips

- Drip products deliver water directly to the root zone. Use dripline for dense plantings where it's cost effective to distribute low-volume water evenly. Use a system of precise emitter devices for sparse plantings where it's cost effective to separately irrigate each plant
- Use drip to eliminate overspray, and you'll eliminate waste. Eliminate unsightly spray stains on buildings and fences. Eliminate soil erosion, water runoff, and potential litigation. Walkways, roads, and vehicles stay dry
- Ask your tax advisor about capital depreciation when calculating your return-on-investment for a drip retrofit. Save water, and save money at the same time

Xerigation® / Landscape Drip System Overview

Targeted Watering with Xerigation® / Landscape Drip

Rain Bird Xerigation/Landscape Drip products are made especially for low-volume irrigation systems. By delivering water at or near the plants' root zones, Rain Bird Xerigation products offer targeted watering with the following advantages:

- Water conservation
- Greater efficiency (target each plant)
- Design flexibility; simple construction and easily expandable
- Healthier plants
- Reduced liability (e.g. no overspray, no runoff)
- Minimization of weed growth
- Cost savings

Broadest Product Line in the Industry

With over 150 products, Rain Bird has the products needed for your application. Systems can be designed to meet any site requirements and offer many exclusive Rain Bird advances including:

- Flexible XF Series dripline with advanced polymers that provide kink-resistance and reduced coil memory for easier installation
- Compact Control Zones with combined pressure regulator and filter to reduce parts, potential leak problems, and allow for fitting more Control Zones in a valve box
- Precision low volume SQ spray nozzles that offer a square wetting pattern and adjust to either 2.5' or 4' throw distances
- Point-source emitters that provide pressure compensation with a wide selection of flow rates and three inlet options (Barb, 1032 threaded, and ½" FPT)
- XFS dripline with Copper Shield Technology™ for use in sub-surface applications under turf or shrub and groundcover areas. The copper chip effectively protects the emitter from root intrusion

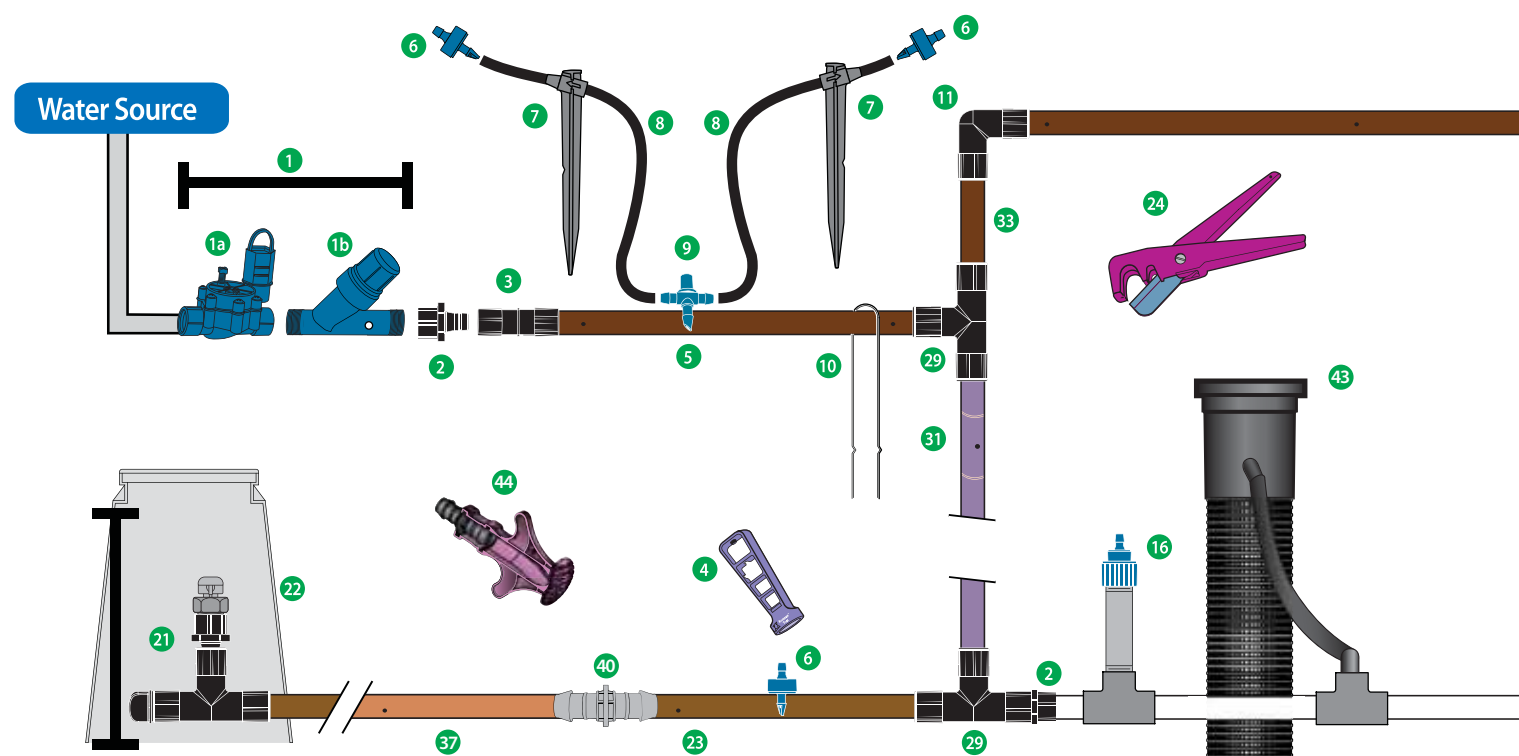

1. Control Zone Kit (pg. 140)
- 1a. Low Flow Valve (pg. 147)
- 1b. Pressure Regulating Filter (pg. 148)
2. Easy Fit Female Adapter (pg. 132)
3. Easy Fit Coupling (pg. 132)
4. Xeriman Tool (pg. 138)
5. XF Series Blank Tubing (pg. 133)
6. Xeri-Bug Emitter (pg. 110)

7. ¼" Tubing Stake (pg. 122)
8. XQ ¼" Distribution Tubing (pg. 136)
9. ¼" Barb Tee (pg. 137)
10. Tie-Down Stake (pg. 137)
11. Easy Fit Elbow (pg. 132)
12. Diffuser Bug Cap (pg. 122)
13. PC Emitter Diffuser Cap (pg. 122)
14. PC Module-1032 (pg. 114)

15. PolyFlex Riser Assembly (pg. 123)
16. Xeri-Bug Emitter - ½" FPT (pg. 110)
17. ¼" Self-Piercing Barb Connector (pg. 112)
18. SQ Series Square Nozzle (formerly XPCN) (pg. 116)
19. Xeri-Pop (pg. 118)
20. Xeri-Bubbler SPYK (pg. 119)
21. ARV050 Air Relief Valve Kit (pg. 134)
22. SEB-7X Emitter Valve Box (pg. 137)

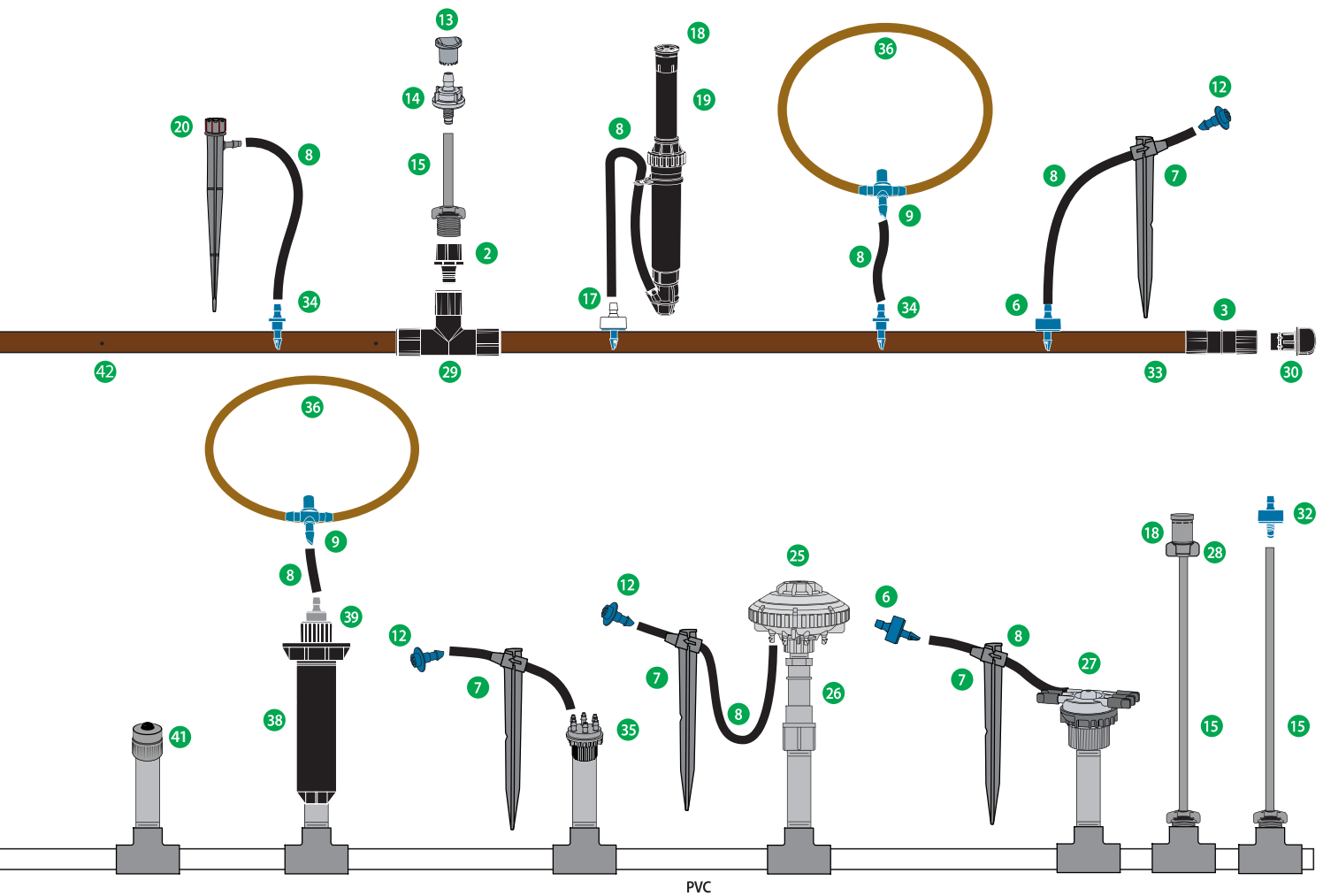
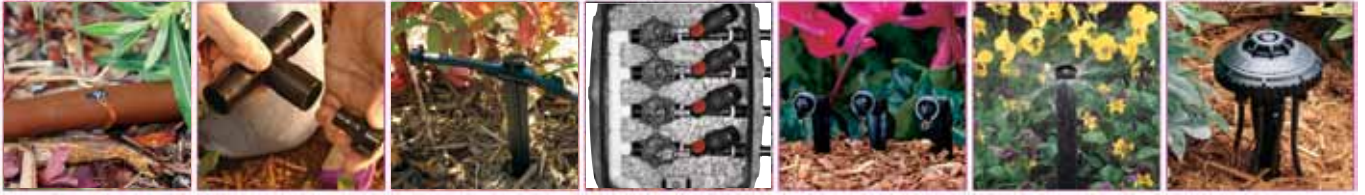

- | | | |
|---|--|--|
| 23. XFD Dripline (pg. 125) | 31. Purple XF Dripline (pg. 125) | 38. RETRO-1800 Spray-to-Drip Retrofit Kit (pg. 138) |
| 24. Tubing Cutter (pg. 137) | 32. Xeri- Bug Emitter - 1032 (pg. 110) | 39. XT-025 ½" FPT x Barb Grey Transfer Fitting (pg. 112) |
| 25. Xeri-Bird 8 (pg. 113) | 33. XF Series Blank Tubing (pg. 133) | 40. XFF Coupling (pg. 131) |
| 26. Inline Pressure Regulator (pg. 152) | 34. ¼" Barb Connector (pg. 137) | 41. PCT Bubbler (pg. 114) |
| 27. 6 Outlet Manifold (pg. 112) | 35. Multi-Outlet Xeri-Bug (pg. 112) | 42. XFCV Dripline with Heavy-Duty check valve (pg. 127) |
| 28. SQ Series Nozzle Adapter (pg. 116) | 36. ¼" Landscape Dripline (pg. 136) | 43. RWS (Root Watering System) (pg. 124) |
| 29. Easy Fit Tee (pg. 132) | 37. XFS Sub-Surface Dripline with Copper Shield Technology (pg. 129) | 44. XF Insertion Tool (pg. 131) |
| 30. Easy Fit Flush Cap (pg. 132) | | |

Landscape Drip



XB-05PC, XB-10PC, XB-20PC



XB-05PC-1032, XB-10PC-1032, XB-20PC-1032
1032-threaded models are specifically designed to be used with PolyFlex Risers, 1032 thread adapters (1032-A), or 1800 Xeri-Bubbler Adapter (XBA-1800)

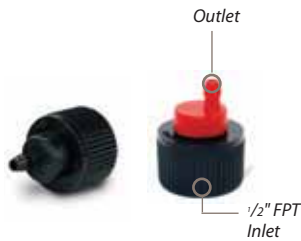

XBT-10, XBT-20

Xeri-Bug™ Emitters

Point-Source Low-Flow Emitters for Watering the Root Zones of Plants, Trees, and Container Plants

Features

- The only emitters with self-piercing barbs, making them the easiest to install using the Xeriman™ tool
- Widest selection of pressure-compensating emitters, with 3 flow rates and 3 inlet options
- Most compact and unobtrusive emitters
- Flow-rates of 0.5, 1.0 and 2.0 gph (1.89, 3.79 and 7.57 l/h)
 - Pressure-compensating design delivers uniform flow throughout a wide pressure range (15 to 50 psi; 1.0 to 3.5 bar)
- Available with 3 different inlets (1.0 and 2.0 models):
 - Self-piercing barb for quick, one-step insertion into 1/2" or 3/4" drip tubing
 - 10-32 threaded inlet that easily threads into a PolyFlex Riser (see page 123), 1032 Thread adapter (page 123) or 1800 Xeri-Bubbler Adapter (page 123)
 - 1/2" FPT inlet that easily threads onto a 1/2" PVC riser (1.0 and 2.0 gph models)
- Outlet barb securely retains 1/4" Distribution Tubing (XQ)
- Design makes installation and maintenance easy
 - Self-flushing action minimizes clogging
 - Robust design made from highly inert materials that are resistant to chemicals
 - Durable plastic construction is UV-resistant
- Color-coded to identify flow rate

Operating Range

- Flow: 0.5 to 2.0 gph (1.89 to 7.57 l/h)
- Pressure: 15 to 50 psi (1.0 to 3.5 bar)
- Required filtration: 150 to 200 mesh (75 to 100 micron)

Models: barb inlet x barb outlet

- XB-05PC: Blue, 0.5 gph (1.89 l/h)
- XB-10PC: Black, 1.0 gph (3.79 l/h)
- XB-20PC: Red, 2.0 gph (7.57 l/h)

Models: 10-32 thread inlet x barb outlet

- XB-05PC-1032: Blue, 0.5 gph (1.89 l/h)
- XB-10PC-1032: Black, 1.0 gph (3.79 l/h)
- XB-20PC-1032: Red, 2.0 gph (7.57 l/h)

Models: 1/2" FPT inlet x barb outlet

- XBT-10: Black, 1.0 gph (3.79 l/h)
- XBT-20: Black, 2.0 gph (7.57 l/h)

How To Specify

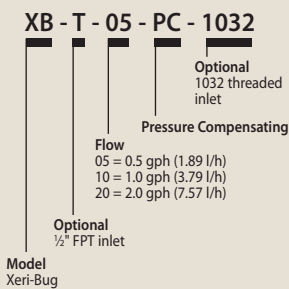

Xeri-Bug Emitter Specifications and Models			
Model	Inlet Type/ Color	Nominal Flow gph	Filtration Required mesh
XB-05PC	Barb/Blue	0.5	200
XB-10PC	Barb/Black	1.0	150
XB-20PC	Barb/Red	2.0	150
XB-05PC1032	10-32T/Blue	0.5	200
XB-10PC1032	10-32T/Black	1.0	150
XB-20PC1032	10-32T/Red	2.0	150
XBT-10PC	½" FPT/Black	1.0	150
XBT-20PC	½" FPT/Black	2.0	150

Xeri-Bug Emitter Specifications and Models			METRIC
Model	Inlet Type/ Color	Nominal Flow l/h	Filtration Required micron
XB-05PC	Barb/Blue	1.89	75
XB-10PC	Barb/Black	3.79	100
XB-20PC	Barb/Red	7.57	100
XB-05PC1032	10-32T/Blue	1.89	75
XB-10PC1032	10-32T/Black	3.79	100
XB-20PC1032	10-32T/Red	7.57	100
XBT-10PC	½" FPT/Black	3.79	100
XBT-20PC	½" FPT/Black	7.57	100



Xeri-Bug™ Emitter, TS025-1/4" stake, and DBC025 Diffuser Bug Cap

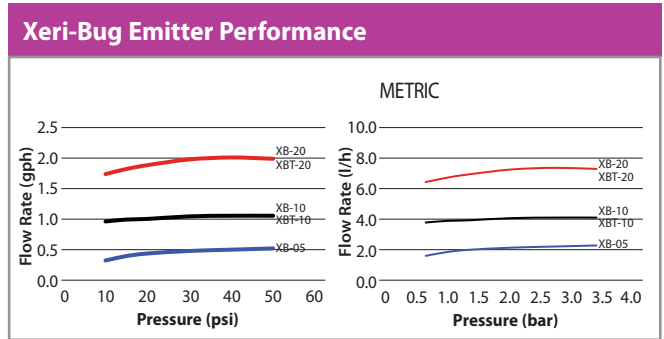

(For reference numbers below, please see the Xerigation System Overview page 108)

Installation Option 1

Using a Xeriman Tool, insert an emitter directly into ½" or ¾" drip tubing or between dripline emitters as needed.



Installation Option 2

For more precise water placement, use ¼" distribution tubing, a ¼" tubing stake, and a bug cap.

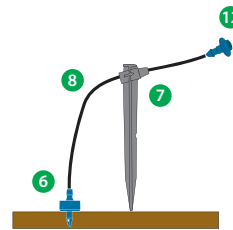

Installation Option 3

For precise water placement, a barbed connector can be punched into distribution tubing. The emitter is then placed at the end of the ¼" distribution tubing. NOTE: should the emitter become dislodged, unregulated flow will occur.

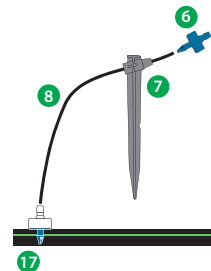

Installation Option 4

The Xeri-Bird 8 provides a centralized location for up to eight emitters. A mix of Xeri-Bug and/or PC emitters can be used to provide the flow rates needed for different plant materials. Tentacles of ¼" distribution tubing, ¼" tubing stakes, and bug caps allow for precise water placement.

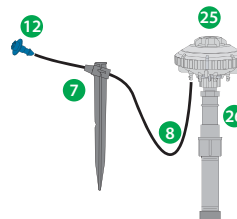

Installation Option 5

The 6 Outlet Manifold provides a centralized water distribution connection for up to six emission devices. Connect the ¼" distribution tubing to one of the outlets. Use a ¼" tubing stake to ensure precise water placement. The emitter is placed on the end of the ¼" distribution tubing to regulate the water flow. NOTE: should the emitter become dislodged, unregulated flow will occur.

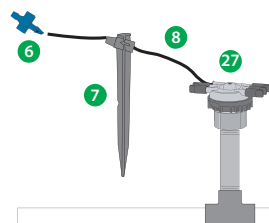

Multi-Outlet Xeri-Bug™

Features

- Pressure compensating design delivers uniform flow throughout a wide pressure range (15 to 50 psi; 1.0 to 3.5 bar)
- Six-outlet emitter supplied with one outlet opened. Simply clip the outlet tips open with snips or clippers for additional operational ports
- Barbed outlets retain ¼" Distribution Tubing (XQ)
- Self-flushing action minimizes clogging
- Durable, UV-resistant color-coded plastic housing

Operating Range

- Flow: 0.5, 1.0 or 2.0 gph (1.89, 3.79 or 7.57 l/h)
- Pressure: 15 to 50 psi (1.0 to 3.5 bar)
- Filtration: 150-mesh (100-microns)

Models: barb inlet x barb outlet

- XB-05-6: Blue, 0.5 gph (1.89 l/h)
- XB-10-6: Black, 1.0 gph (3.79 l/h)
- XB-20-6: Red, 2.0 gph (7.57 l/h)

Models: ½" FPT inlet x barb outlet

- XBT-05-6: Blue, 0.5 gph (1.89 l/h)
- XBT-10-6: Black, 1.0 gph (3.79 l/h)
- XBT-20-6: Red, 2.0 gph (7.57 l/h)



XB-05-6, XB-10-6, XB-20-6



XBT-05-6, XBT-10-6, XBT-20-6

Multi-Outlet Xeri-Bug Emitter Performance

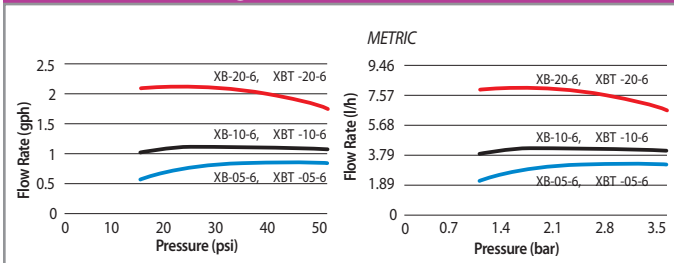

6 Outlet Manifold - EMT-6XERI

Features

- ½" FPT inlet threads onto ½" riser and provides a manifold with six free-flowing ¼" barb outlets
- Each barb outlet is sealed with a durable plastic cap
- Plastic caps remove easily, allowing for a drip area that can be customized with up to six different emission devices
- Attach ¼" Distribution Tubing (XQ) onto each outlet for use with: Xeri-Bugs, PC Modules, Xeri-Pops, Xeri-Sprays, and Xeri-Bubblers

Operating Range

- Pressure: 15 to 50 psi (1.0 to 3.5 bar)

Model

- EMT-6XERI



EMT-6XERI

¼" Self-Piercing Barb Connector

Features

- Used to connect ¼" Distribution Tubing into ½" or ¾" distribution tubing
- Self-piercing barb inlet is easily inserted into ½" or ¾" distribution tubing using a Xeriman™ Tool (XM-Tool)
- Outlet barb accepts ¼" Distribution Tubing (XQ). Gray outlet barb indicates unit has unrestricted flow

Operating Range

- Pressure: 0 to 50 psi (0 to 3.5 bar)

Model

- SPB-025

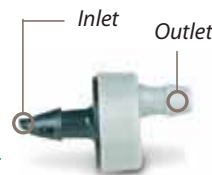

SPB-025

½" FPT x Barb Grey Transfer Fitting

Features

- Grey outlet to designate open flow
- ½" FPT inlet can be easily attached to a schedule 80 riser or the top of an 1800 Retro
- Barbed outlet so ¼" distribution tubing or ¼" drip tubing can be easily and securely attached

Operating Range

- Pressure: 0 to 50 psi (0 to 3.5 bar)

Model

- XT025



XT025

Xeri-Bird™ 8 Multi-Outlet Emission Device

The Most Flexible and Feature-Rich Multi-Outlet Device on the Market, Ideal for New Projects and Retrofit Applications

Features

- The only multi-outlet device on the market with 8 configurable ports and 10 flow options for each port for maximum flexibility
- XBD-80 and XBD-81 models each contain a built-in filter. Makes retro-fitting easy when installed with the optional in-stem pressure regulator (PRS-050 page 152)
- Easy to maintain, because body can be easily removed from riser
- Threads onto any 1/2" riser and delivers water to multiple locations for increased system flexibility
- Each port accepts a Xeri-Bug™ Emitter or PC Module for independent flows from 0.5 to 24 gph (1.89 to 90.84 l/h) or use a self-piercing barb connector (SPB-025) for unrestricted flow
- XBD-80 and XBD-81 models each feature an integral 200 mesh (75 micron) filter which is easily serviceable from the top of the unit
- Eight bottom-mounted, sure-grip barbed outlets securely retain 1/4" Distribution Tubing (XQ)
- Unique union base nut allows removal of Xeri-Bird 8 body from riser for easy installation and maintenance
- Emitters must be installed inside the Xeri-Bird to prevent excess back pressure

Operating Range

- Flow: 0 to 24 gph (0 to 90.84 l/h) per outlet
- Pressure: 15 to 50 psi (1.0 to 3.5 bar)

Models

- XBD-80: Xeri-Bird 8 unit (includes 7 removable port plugs and filter)
- XBD-81: Xeri-Bird 8 unit (includes eight 1 gph (3.79 l/h) Xeri-Bug emitters factory installed, and filter)

Replacement Parts:

- XBD8SCRN: replacement screen and two o-rings



XBD-80



XBD-80 With 8 Xeri-Bugs and In-Stem Regulator Shown Installed (Order Xeri-Bugs and In-Stem Pressure Regulator Separately)



Helpful Hint: Always install emitters with the pointed end (inlet barb) or threaded end up, as shown

* Must be installed second
**Must be installed first



PC-05, PC-07, PC-10



PC-12, PC-18, PC-24



PC-05-1032, PC-07-1032, PC-10-1032

10-32-threaded models are specifically designed to be used with PolyFlex Risers, 10-32 thread adapters (1032-A), or 1800 Xeri-Bubbler Adapter (XBA-1800)



PCT-05, PCT-07, PCT-10

1/2" FPT inlet that easily threads onto a 1/2" PVC riser

How To Specify

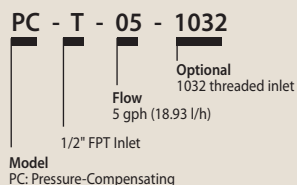

Pressure-Compensating Modules

Point-Source Medium-Flow Emitters for Watering Larger Shrubs and Trees

Features

- The only emitters with self-piercing barbs, making them the easiest to install using the Xeriman™ tool
- Widest selection of pressure-compensating emitters, with 6 flow rates and 3 inlet options
- Most compact and unobtrusive emitters
- Flow rates from 5 to 24 gph (18.93 to 90.84 l/h)
- Pressure-compensating design delivers uniform flow throughout a wide pressure range (10 to 50 psi; 0.7 to 3.5 bar)
- Available with 3 different inlets:
 - Self-piercing barbs for quick one-step emitter insertion into 1/2" or 3/4" drip tubing
 - 10-32 threaded inlet that easily threads into a PolyFlex Riser (see page 123), 1032 Thread adapter (page 123) or 1800 Xeri-Bubbler Adapter (page 123)
 - 1/2" FPT inlet that easily threads onto a 1/2" PVC riser
- Robust design - durable plastic construction is UV-resistant and color-coded to identify flow rate

Operating Range*

- Flow: 5 to 24 gph (18.93 to 90.84 l/h)
- Pressure: 10 to 50 psi (0.7 to 3.5 bar)
- Required filtration: 100 mesh (150 micron)

* **Note:** Use a PC Diffuser Cap to eliminate squirting water when using a PC Module staked at the end of 1/4" Distribution Tubing (XQ) or on a PolyFlex Riser (PFR/FRA)

Models: barb inlet x barb outlet

- PC-05: Light brown, 5 gph (18.93 l/h)
- PC-07: Violet, 7 gph (26.50 l/h)
- PC-10: Green, 10 gph (37.85 l/h)
- PC-12: Dark brown, 12 gph (45.42 l/h)
- PC-18: White, 18 gph (68.13 l/h)
- PC-24: Orange, 24 gph (90.84 l/h)

Models: 10-32 thread inlet x barb outlet

- PC-05-1032: Light brown, 5 gph (18.93 l/h)
- PC-07-1032: Violet, 7 gph (26.50 l/h)
- PC-10-1032: Green, 10 gph (37.85 l/h)

Models: 1/2" FPT thread Inlet

- PCT-05: Light Brown, 5 gph (18.93 l/h)
- PCT-07: Violet, 7 gph (26.50 l/h)
- PCT-10: Green, 10 gph (37.85 l/h)

Pressure-Compensating Modules

Pressure-Compensating Module Models			
Model	Inlet Type/ Outlet/Color	Nominal Flow gph	Filtration Required mesh
PC-05	Barb / light brown	5	100
PC-07	Barb / violet	7	100
PC-10	Barb / green	10	100
PC-12	Barb / dark brown	12	100
PC-18	Barb / white	18	100
PC-24	Barb / orange	24	100
PC-05-1032	10-32T / light brown	5	100
PC-07-1032	10-32T / violet	7	100
PC-10-1032	10-32T / green	10	100
PCT-05	NPT / light brown	5	100
PCT-07	NPT / violet	7	100
PCT-10	NPT / green	10	100

Pressure-Compensating Module Models METRIC			
Model	Inlet Type/ Outlet/Color	Nominal Flow l/h	Filtration Required micron
PC-05	Barb / light brown	18.93	150
PC-07	Barb / violet	26.50	150
PC-10	Barb / green	37.85	150
PC-12	Barb / dark brown	45.42	150
PC-18	Barb / white	68.13	150
PC-24	Barb / orange	90.84	150
PC-05-1032	10-32T / light brown	18.93	150
PC-07-1032	10-32T / violet	26.50	150
PC-10-1032	10-32T / green	37.85	150
PCT-05	NPT / light brown	18.93	150
PCT-07	NPT / violet	26.50	150
PCT-10	NPT / green	37.85	150

Pressure-Compensating Modules & Bubblers Performance

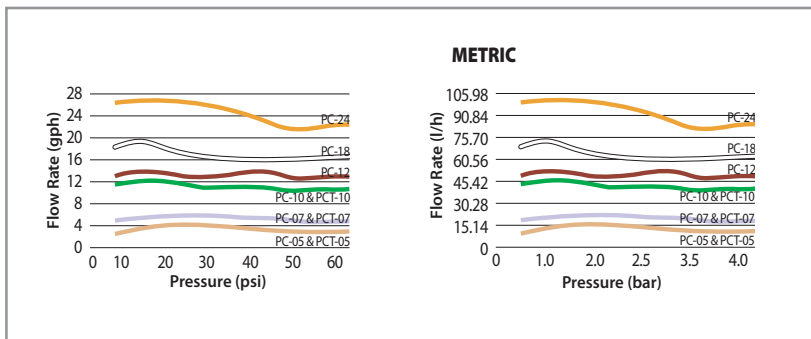

PC Diffuser Caps



PC Diffuser

PC Diffuser Caps are designed to fit onto outlet of pressure-compensating drip modules

Models: (see page 122 for complete information)

- PC Diffuser: Black
- PC-DIFF-PPL: Purple, to designate non-potable water



PC Module with PC Diffuser Cap on PolyFlex Riser (PolyFlex Risers available in 12" and 24" models)



SQ Nozzle Installed on PolyFlex Riser
with Nozzle Adapter



SQ Nozzles with Screens

One Nozzle...Two Throws

With a simple turn of the nozzle to the next preset stop, the Rain Bird SQ Nozzle adjusts from a 2.5' (0.8 m) throw to a 4' (1.2 m) throw. It's like having two nozzles in one.



Can be used on...

The SQ Nozzle is an ideal solution for a wide range of difficult-to-design areas, thanks to its compatibility with popular irrigation products.



1800® Series
Spray Heads

Xeri-Pop
Spray Heads

Polyflex
Risers

Schedule 80
Risers

SQ Series, Square Pattern Nozzles

The Most Precise and Efficient, Low-Volume Spray Solution for Irrigation of Small Areas with Dense Plantings

Features

- Square spray pattern and pressure compensation offer increased efficiency and control, reducing overspray, property damage and liability
- Simplify design and installation with the flexibility of applications: one nozzle throws 2.5' or 4' (0.8 m or 1.2 m) and can be used on a variety of spray heads and risers
- Meets micro irrigation system requirement for less than 26 gph flow rate at 30 psi
- Square spray pattern with edge-to-edge coverage allows you to easily design and install in small spaces
- Pressure compensation design delivers uniform flow over the pressure range
- Available in 3 models—quarter, half and full patterns with matched precipitation rate
 - Virtually no-mist performance from 20 psi to 50 psi
 - Two throw distances in each nozzle. One simple click adjusts to 2.5' or 4' (0.8 m or 1.2 m)
 - Shipped with blue filter screen (0.02" x 0.02") to maintain precise distance of flow, and to prevent clogging
- Compatible with all 1800 Sprays, Xeri-Pops, New PolyFlex Riser Adapter, UNI-Spray and SCH 80 risers



Operating Range



- Pressure: 20 to 50 psi (1.4 to 3.5 bar)
- Flow rates: 6, 12 and 24 gph (22.7, 45.4 and 90.8 l/h)
- Required filtration: 40 mesh



Models



- SQ-QTR: SQ Nozzle, quarter pattern
- SQ-HLF: SQ Nozzle, half pattern
- SQ-FUL: SQ Nozzle, full pattern
- SQ-ADP12: SQ Nozzle Adapter with 12" PolyFlex Riser
- SQ-ADP24: SQ Nozzle Adapter with 24" PolyFlex Riser
- SQ-ADP: SQ PolyFlex Riser Adapter only

* **Note:** A PA-8S Plastic Shrub Adapter (see page 11) is needed when using an SQ Series Nozzle mounted on a SCH 80 riser.

SQ Nozzle Performance					
2.5 feet throw @ 6" height above grade					
Nozzle	Pressure psi	Throw Radius ft.	Flow gph	Flow gpm	Precip. Rate w/no overlap in/h
Q 	20	2.5	6.4	0.11	1.64
	30	2.5	7.4	0.12	1.90
	40	3.0	7.4	0.12	1.32
	50	3.0	7.4	0.12	1.32
H 	20	2.5	10.2	0.17	1.31
	30	2.5	12.2	0.20	1.57
	40	3.0	13.7	0.23	1.22
	50	3.0	13.7	0.23	1.22
F 	20	2.5	20.0	0.33	1.28
	30	2.5	24.2	0.40	1.55
	40	3.0	27.3	0.46	1.22
	50	3.0	27.3	0.46	1.22

SQ Nozzle Performance					METRIC
0.8 m throw @ 0.15 m height above grade					
Nozzle	Pressure bar	Throw Radius m.	Flow lph	Flow lpm	Precip. Rate w/no overlap mm/h
Q 	1.4	0.8	24	0.40	42
	2.1	0.8	28	0.47	48
	2.8	0.9	28	0.47	34
	3.4	0.9	28	0.47	34
H 	1.4	0.8	39	0.65	33
	2.1	0.8	46	0.77	40
	2.8	0.9	52	0.87	31
	3.4	0.9	52	0.87	31
F 	1.4	0.8	76	1.27	33
	2.1	0.8	92	1.53	39
	2.8	0.9	103	1.72	31
	3.4	0.9	103	1.72	31

SQ Nozzle Performance					
4 feet throw @ 6" height above grade					
Nozzle	Pressure psi	Throw Radius ft.	Flow gph	Flow gpm	Precip. Rate w/no overlap in/h
Q 	20	4.0	6.4	0.11	0.64
	30	4.0	7.4	0.12	0.74
	40	4.5	7.4	0.12	0.59
	50	4.5	7.4	0.12	0.59
H 	20	4.0	10.2	0.17	0.51
	30	4.0	12.2	0.20	0.61
	40	4.5	13.7	0.23	0.54
	50	4.5	13.7	0.23	0.54
F 	20	4.0	20.0	0.33	0.50
	30	4.0	24.2	0.40	0.61
	40	4.5	27.3	0.46	0.54
	50	4.5	27.3	0.46	0.54

SQ Nozzle Performance					METRIC
1.2 m throw @ 0.15 m height above grade					
Nozzle	Pressure bar	Throw Radius m.	Flow lph	Flow lpm	Precip. Rate w/no overlap mm/h
Q 	1.4	1.2	24	0.40	16
	2.1	1.2	28	0.47	19
	2.8	1.4	28	0.47	15
	3.4	1.4	28	0.47	15
H 	1.4	1.2	39	0.65	13
	2.1	1.2	46	0.77	16
	2.8	1.4	52	0.87	14
	3.4	1.4	52	0.87	14
F 	1.4	1.2	76	1.27	13
	2.1	1.2	92	1.53	15
	2.8	1.4	103	1.72	14
	3.4	1.4	103	1.72	14

Performance data taken in zero wind conditions

SQ Nozzles

Quarter Model

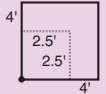

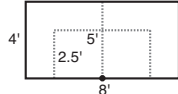

Half Model

Full Model

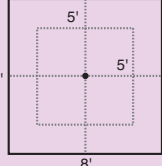

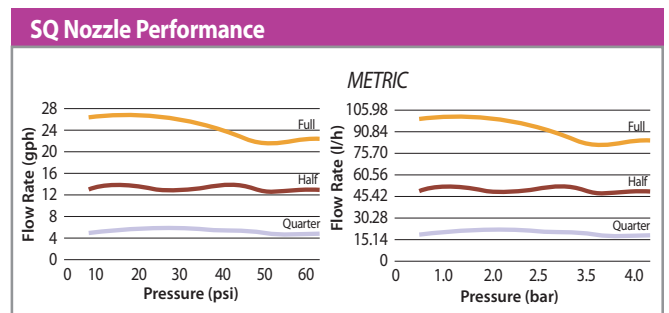
Xeri-Pop™ Micro-Spray

The Xeri-Pop™ Micro-Spray Makes It Easy to Integrate a Durable Micro-Spray into a Low-Volume Irrigation Design

Features

- The only pop-up spray that works in low-volume low-pressure application, and this is the perfect solution to vandal-prone areas
- Xeri-Pops can be installed and located in nearly any location and are ideal for small, odd-shaped planting beds; the 12" version is perfect for annual flower beds
- Xeri-Pops work with Rain Bird 5' and 8' MPR nozzles and SQ Series Nozzles — nozzles with square spray patterns and adjustable throws of 2.5' and 4'
- The Xeri-Pop can operate with 20 to 50 psi base pressure when water is supplied via ¼" Distribution Tubing (XQ)
- The flexibility of ¼" tubing allows the Xeri-Pop to be easily located and relocated as planting conditions dictate
- A durable, plastic snap-collar (on 4" and 6" models) secures the ¼" tubing to the outside of the Xeri-Pop case
- The Xeri-Pop's ¼" Distribution Tubing can readily connect to ½" or ¾" polyethylene tubing or to a multi-outlet manifold (EMT-6XERI). Connections to polyethylene tubing are accomplished with either an SPB-025 ¼" Self-piercing barb Connector or an XBF1CONN ¼" barb Connector
- External parts are UV-resistant and available in 4", 6" and 12" pop up heights

Operating Range

- Pressure: 20 to 50 psi (1.4 to 3.5 bar)
- Filtration: Depends on nozzle used with Xeri-Pop

Models

- XP-400X: 4-inch pop-up
- XP-600X: 6-inch pop-up
- XP-1200X: 12-inch pop-up

Nozzle Options

- SQ Series Nozzles (page 116)
- 5 Series MPR Nozzle (all configurations)
- 5 Series Plastic Bubbler
- 8 Series MPR Nozzle (8H, 8T and 8Q)



12" Xeri-Pop in planting bed

XP-400X



XP-600X



XP-1200X



How To Specify

XP - 600X

Model
Xeri-Pop

Pop-Up Height
400X = 4" Pop-up
600X = 6" Pop-up
1200X = 12" Pop-up

Always install a PCS-010, -020, 030, or -040 Pressure-Compensating Screen whenever a 5B Bubbler Nozzle is installed on a Xeri-Pop.

Xeri-Bubblers™

Ideal for Shrub Plantings, Trees, Containers, and Flower Beds

Features

- Adjust flow and radius by turning outer cap
- Clean by completely unscrewing cap from base unit
- Three convenient installation connections available for design flexibility: 10-32 self-tapping thread, 1/4" barb, and 5" spike

Operating Range

- SXB Series flow: 0 to 13 gph (0 to 49.21 l/h)
- UXB Series flow: 0 to 35 gph (0 to 132.48 l/h)
- Pressure: 15 to 30 psi (1.0 to 2.1 bar)

Models

- SXB-180-1032: Half-circle, 5 streams, 10-32 thread
- SXB-180-025: Half-circle, 5 streams, 1/4" barb
- SXB-180-SPYK: Half-circle, 5 streams, 5" spike; includes barb x barb coupler
- SXB-360-1032: Full-circle, 8 streams, 10-32 thread
- SXB-360-025: Full-circle, 8 streams, 1/4" barb
- SXB-360-SPYK: Full-circle, 8 streams, 5" spike includes barb x barb coupler
- UXB-360-1032: Full-circle, umbrella, 10-32 thread
- UXB-360-025: Full-circle, umbrella, 1/4" barb
- UXB-360-SPYK: Full-circle, umbrella, 5" spike includes barb x barb coupler

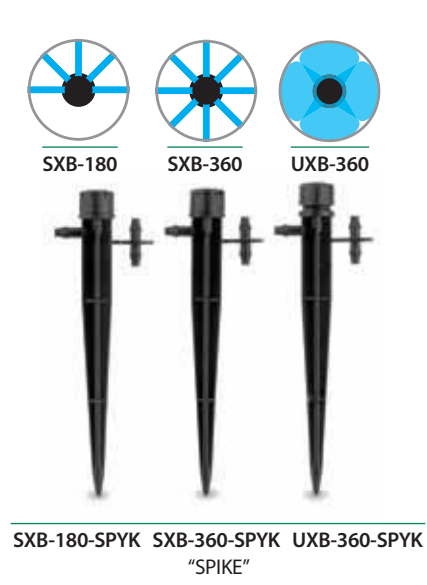
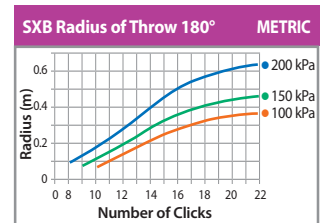
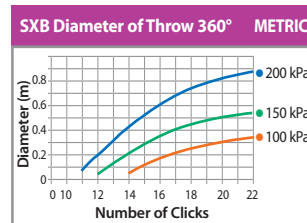
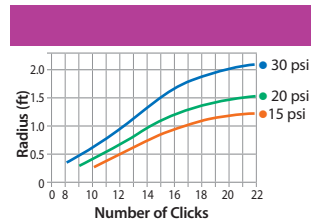
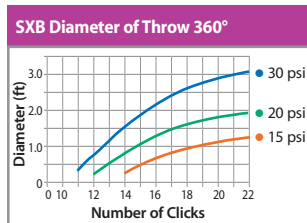
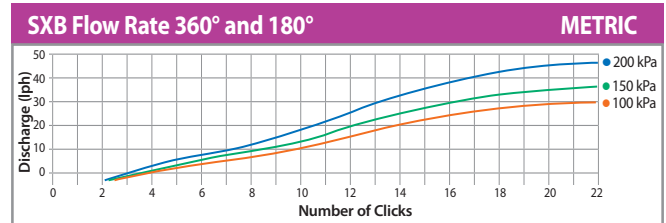
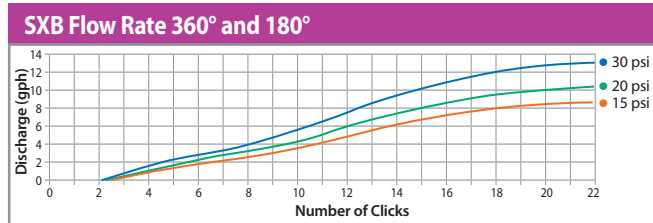

How To Specify

SXB - 180 - 1032

Connection
1032: 10-32 self-tapping thread
025: 1/4" barb
SPYK: 5" spike

Pattern
180 = Half circle
360 = Full-circle

Model
SXB: Stream Bubbler
UXB: Umbrella Bubbler

Landscape Drip

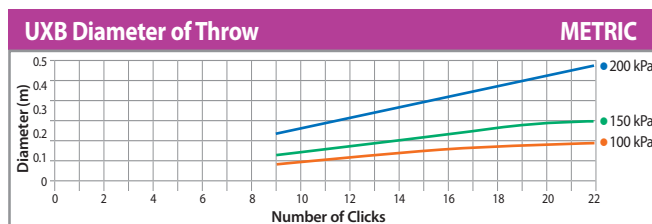
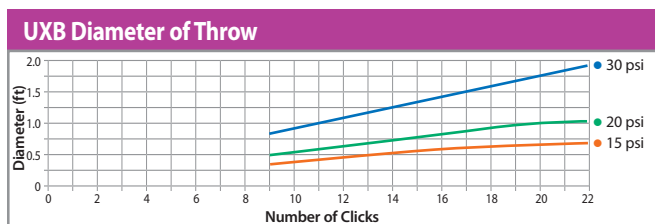
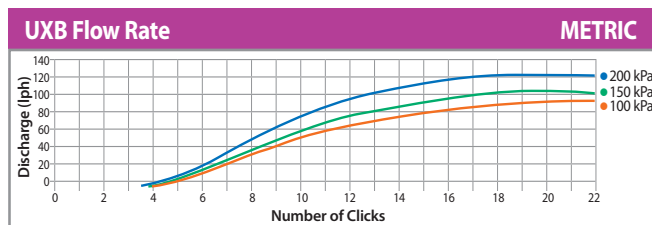
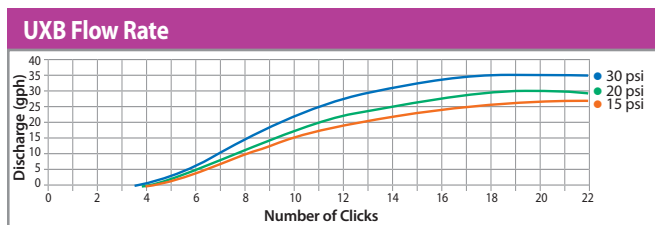

Xeri-Sprays™ and Misters

Ideal for Ground Cover, Mass Plantings, Annual Flower Beds, and Containers

Features

- Adjust flow/radius by turning integral ball valve
- Uniform emission pattern provides excellent distribution
- 10-32 self-tapping threads fit into 1/2" x 10-32 adapter (10-32A); 1800 Xeri-Bubbler™ adapter (XBA-1800); and PolyFlex Riser (PFR-12)

Operating Range

- Flow: 0 to 31 gph (0 to 117.34 l/h)
- Pressure: 10 to 30 psi (0.75 to 2.1 bar)
- Radius: 0 to 13.4 feet (0 to 4.1 m) full-circle; 0 to 10.6 feet (0 to 3.2 m) quarter- and half-circle

Models

- XS-090: Quarter-circle, spray
- XS-180: Half-circle, spray
- XS-360: Full-circle, stream spray
- X360 ADJMST: Full-circle, mist

Xeri-Spray™ 360° True Spray

Ideal for Mass Plantings, Ground Cover, Annual Flower Beds and Containers

Features

- True micro-spray with full-circle fan spray pattern
- Adjust flow/radius by turning outer cap
- Three convenient installation connections for design flexibility: 10-32 self-tapping thread, 1/4" barb and 5" spike
- Easily cleaned by completely unscrewing cap from base unit

Operating Range

- Flow: 0 to 24.5 gph (0 to 92.7 l/h)
- Pressure: 15 to 30 psi (1.0 to 2.1 bar)
- Radius: 0 to 6.7 feet (0 to 2.0 m)

Models

- XS-360TS-1032: 10-32 threads
- XS-360TS-025: 1/4" barb
- XS-360TS-SPYK: 5" spike; includes barb x barb coupler

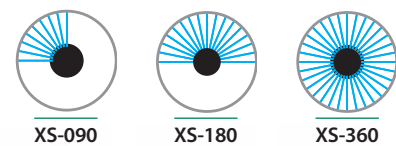

Xeri-Sprays™ and Misters Performance						
Pressure psi	Flow gph	XS-90 Radius of Throw ft.	XS-180 Radius of Throw ft.	XS-360 Radius of Throw ft.	360 Mister Radius of Throw ft.	
10	0-16.7	0-6.4	0-6.7	0-9.2	0-1.5	
15	0-21.0	0-8.1	0-8.1	0-11.3	0-1.3	
20	0-24.5	0-9.4	0-9.5	0-12.9	0-1.5	
25	0-28.0	0-9.8	0-10.1	0-13.2	0-1.4	
30	0-31.0	0-10.3	0-10.6	0-13.4	0-1.3	

Xeri-Sprays™ and Misters Performance						METRIC
Pressure bar	Flow l/h	XS-90 Radius of Throw m.	XS-180 Radius of Throw m.	XS-360 Radius of Throw m.	360 Mister Radius of Throw m.	
0.7	0-63.21	0-2.0	0-2.0	0-2.8	0-0.46	
1.0	0-79.49	0-2.5	0-2.5	0-3.4	0-0.40	
1.4	0-92.73	0-2.9	0-2.9	0-3.9	0-0.44	
1.7	0-105.98	0-3.0	0-3.1	0-4.0	0-0.43	
2.1	0-117.34	0-3.1	0-3.2	0-4.1	0-0.40	

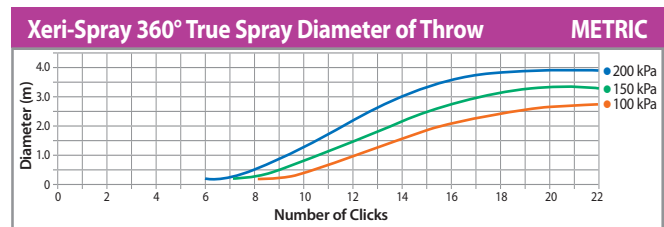
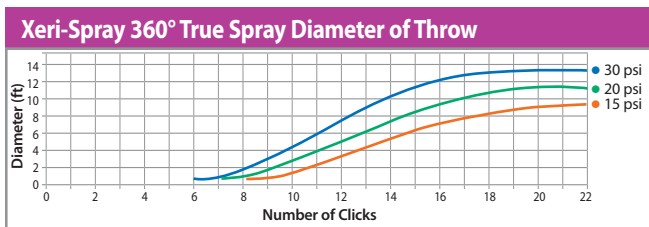
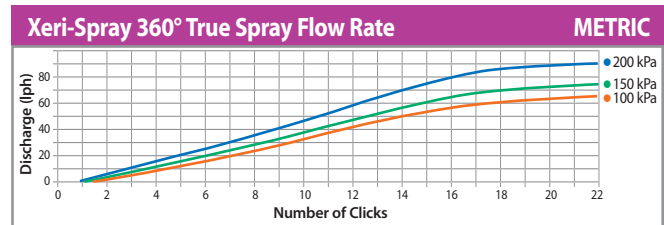
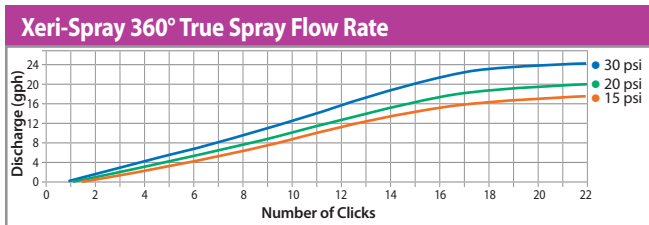

Landscape Drip

Diffuser Bug Cap

Features

- Prevents bugs and other debris from clogging 1/4" Distribution Tubing
- Barbed inlet fits into 1/4" Distribution Tubing (XQ)
- Flanged shield diffuses water to minimize soil erosion at emission point

Operating Range

- Pressure: 0 to 50 psi (0 to 3.5 bar)

Models

- DBC-025: Black

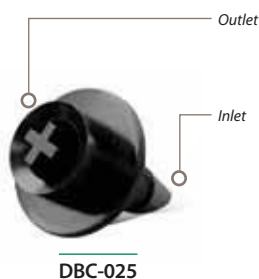

PC Diffuser Cap

Features

- Cap snaps securely onto the PC Module and XB emitter outlet to create bubbler effect and prevent wash out
- Designed for quick and easy installation
- Made of UV-resistant polyethylene material

Models

- PC Diffuser: Black
- PC-DIFF-PPL: Purple to designate non-potable water



Suggested Applications

Landscape Drip



A. 1/4" tubing, 1/4" stake, PC Module, Diffuser Bug Cap.
Used for runs greater than 5 feet from main line

B. 1/4" tubing, 1/4" stake, Diffuser Bug Cap.
Used for runs up to 5 feet from main line

(Drip emitter not shown – installed directly into lateral line)

Universal 1/4" Tubing Stake

Features

- Holds 1/4" Distribution Tubing and emitter or Diffuser Bug Cap firmly in place at the root zone of the plant
- Designed to securely hold Rain Bird and other manufacturers' 1/4" Distribution Tubing — 0.16" to 0.18" I.D. and 0.22" to 0.25" O.D.
- Rigid stake featuring a flat enlarged head designed to withstand hammering into tough soil

Note: If emitter is installed at inlet to distribution tubing, use a Diffuser Bug Cap (DBC-025) at outlet of tubing to prevent bugs from clogging tubing and to help hold tubing in place

Model

- TS-025

TS-025

1/4" Tubing Stake with Cap

Features

- Locking cap holds tubing in place
- Used for holding 1/4" Distribution Tubing (XQ) in place at the plant root zone
- Accepts 1/4" Distribution Tubing from 0.19 O.D. to 0.256 O.D.
- Bug cap included
- Constructed of UV-resistant plastic material

Model

- TS-025WCAP

TS-025WCAP



12" PolyFlex Riser

Features

- 12" riser that is used with any 10-32 threaded emission device to deliver water directly to a plant. These include Xeri-Bugs, PC Modules, Xeri-Bubblers and Xeri-Sprays
- Extremely rugged and reliable – constructed of thick-walled, high-density polyethylene
- Can be used with a riser-stake (RS-025T)

Operating Range

- Pressure: 15 to 50 psi (1.0 to 3.5 bar)

Model

- PFR-12

PFR-12



PolyFlex Riser and Adapter Assemblies

Features

- 12" or 24" riser that is pre-assembled with a 1/2" male threaded base that simplifies installation
- Use with any 10-32 threaded emission device to deliver water directly to a plant. These include Xeri-Bugs, PC Modules, Xeri-Bubblers and Xeri-Sprays
- Newly-designed adapter with larger tabs makes installation quicker and easier; can be used on PVC laterals, or with any 1/2" female threaded adapter
- Adapter made of heavy-duty Marlex®, which requires no Teflon® tape, saving time during installation
- Extremely rugged and reliable PolyFlex Riser constructed of thick-walled, high-density polyethylene

Operating Range

- Pressure: 15 to 50 psi (1.0 to 3.5 bar)

Models

- PFR-FRA: 12" (30.5 cm) PolyFlex Riser and adapter
- PFR-FRA24: 24" (61.0 cm) PolyFlex Riser and adapter

PFR-FRA



PolyFlex Riser and Stake Assembly

Features

- 12" riser that is pre-assembled with a 7" (30.5 cm) stake
- Use with any 10-32 threaded emission device to deliver water directly to a plant. These include Xeri-Bugs, PC Modules, Xeri-Bubblers and Xeri-Sprays
- Saves time and money when installing a low-volume irrigation system
- Extremely rugged and reliable PolyFlex Riser constructed of thick-walled, high-density polyethylene

Operating Range

- Pressure: 15 to 50 psi (1.0 to 3.5 bar)

Model

- PFR-RS: 12" (30.5 cm) PolyFlex Riser and 7" (30.5 cm) stake

PFR-RS



Riser Stake-Threaded

Features

- Rugged 5" (12.7 cm) stake for use with PolyFlex Risers
- Constructed of UV-resistant plastic material
- Barbed side inlet accepts 1/4" Distribution Tubing (XQ)
- 10-32 threaded outlet permits easy threading of 12" (30.5 cm) PolyFlex Riser (PFR-12)

Operating Range

- Pressure: 15 to 50 psi (1.0 to 3.5 bar)

Model

- RS-025T

RS-025T



10-32 Thread Adapter

Features

- Inlet: 1/2" FPT that screws onto any 1/2" MPT riser
- Outlet: 10-32 threads that accept Xeri-Bugs, PC Modules, Xeri-Bubblers and Xeri-Sprays with 10-32 threads
- Constructed of UV-resistant plastic material

Operating Range

- Pressure: 15 to 50 psi (1.0 to 3.5 bar)

Model

- 10-32A

10-32A



1800 Xeri-Bubbler Adapter

Features

- Inlet: 1/2" female threads that screw onto a Rain Bird 1800 series or UNI-Spray or shrub adapter
- Outlet: 10-32 threads that accept any emission device with 10-32 threads including Xeri-Bugs, PC Modules, Xeri-Bubblers and Xeri-Sprays
- Sits at grade when installed on a spray head for a robust installation

Operating Range

- Pressure: 15 to 50 psi (1.0 to 3.5 bar)

Model

- XBA-1800

XBA-1800



RWS (Root Watering System)

Root Watering System promotes deep root growth, healthy tree development, and accelerated growth

Features and Benefits

- Subsurface aeration and irrigation prevents tree and shrub transplant shock
- Highest efficiency solution for tree irrigation - up to 95% emission uniformity with minimal wind, evaporation, or edge control losses
- Aesthetically designed subsurface bubbler contributes to a landscape's natural appearance
- Locking grate at grade deters vandals
- Helps prevent shallow root growth and hardscape damage
- Aesthetically attractive below grade installation
- Self-contained and factory assembled units for assured reliability

For the RWS Model:

- 4" (10.2 cm) retaining cap and vandal resistant locking grate tops a 36" (91.4 cm) semi-rigid mesh tube
- Factory installed swing assemblies (excluding RWS) with a 1401 (0.25 gpm; 0.95 l/m), 1402 (0.5 gpm; 1.9 l/m), or 1404 (1.00 gpm; 3.8 l/m) bubbler on a fixed riser makes connecting to lateral lines easy
- Options: Check valve to keep lines from draining
Sand sock for use in fine soils

For the RWS - Mini:

- 4" (10.2 cm) retaining cap and vandal resistant locking grate tops a 18" (45.7 cm) semi-rigid mesh tube

- Factory installed ½" spiral barb elbow with a 1401 or 1402 bubbler makes connecting to lateral lines easy
- Options: Check valve to keep lines from draining
Sand sock for use in fine soils

For the RWS - Supplemental:

- 2" (5.1 cm) snap-on cap and base cap enclose a 10" (25.4 cm) semi-rigid mesh tube
- Factory installed ½" spiral barb elbow with 1401 bubbler makes connecting to lateral lines easy
- Options: Check valve to keep lines from draining
Sand sock for use in fine soils

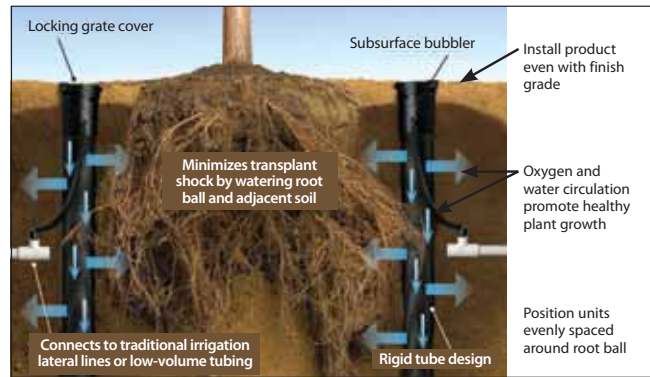

Models / Specifications

Model	Bubbler	Check Valve*	Swing Assembly w/ ½" (15/21) M NPT inlet	Spiral Barb Elbow w/ ½" (15/21) M NPT inlet
Root Watering System (with 4" (10.2 cm) vandal-resistant locking grate)				
RWS	Ideal for ¼" drip tubing or customer provided hardware	-	-	-
RWS-B-C-1401	0.25 gpm (0.95 l/m)	✓	✓	-
RWS-B-1401	0.25 gpm (0.95 l/m)	-	✓	-
RWS-B-X-1401	0.25 gpm (0.95 l/m)	-	✓ (18")	-
RWS-B-C-1402	0.50 gpm (1.9 l/m)	✓	✓	-
RWS-B-1402	0.50 gpm (1.9 l/m)	-	✓	-
RWS-B-C-1404	1.00 gpm (3.8 l/m)	✓	✓	-
Root Watering System - Mini (with 4" (10.2 cm) vandal-resistant locking grate)				
RWS-M	Ideal for ¼" drip tubing or customer provided hardware	-	-	-
RWS-M-B-C-1401	0.25 gpm (0.95 l/m)	✓	-	✓
RWS-M-B-1401	0.25 gpm (0.95 l/m)	-	-	✓
RWS-M-B-C-1402	0.50 gpm (1.9 l/m)	✓	-	✓
RWS-M-B-1402	0.50 gpm (1.9 l/m)	-	-	✓
Root Watering System - Supplemental (with 2" (5.1 cm) snap-on cap and base)				
RWS-S-B-C-1401	0.25 gpm (0.95 l/m)	✓	-	✓
RWS-S-B-1401	0.25 gpm (0.95 l/m)	-	-	✓
Root Watering - Accessories				
RWS-SOCK (Root Watering Sock)				
RWS-GRATE-P (Root Watering System Purple Grate for RWS and RWS Mini)				

*Check Valve is 14 ft. of holdback, or 6 PSI

XFD On-Surface Dripline

The Most Flexible, Pressure-Compensating In-line Emitter Tubing Available to Irrigate Ground Cover, Dense Plantings, Hedge Rows and More

Features

- Extra flexible tubing for fast, easy installation
- Dual-layered tubing (brown over black or purple over black) provides unmatched resistance to chemicals, UV damage and algae growth
- Patent pending emitter design provides for increased reliability
- Longer lateral runs than competition
- Unique material offers significantly greater flexibility, allowing tighter turns with fewer elbows for easier installation
- Choice of flow rates, spacing and coil lengths provides design flexibility for a variety of non-turfgrass applications
- Accepts Rain Bird Easy Fit Compression Fittings (pg 132), XF Dripline Insert Fittings (pg 131) and 17mm insert fittings (pg 131)
- Use an Air/Vaccum Relief Valve Kit when installation is below soil (pg 134)

Operating Range

- Pressure: 8.5 to 60 psi (0.58 to 4.1 bar)
- Flow rates: 0.4 gph, 0.6 gph, and 0.9 gph (1.6 l/h, 2.3 l/h, and 3.5 l/h)
- Temperature: Water up to 100° F (37.8C); Ambient up to 125° F (51.7C)
- Required filtration: 120 mesh

Specifications

- Outside diameter: 0.634" (16.1 mm)
- Inside diameter: 0.536" (13.6 mm)
- Wall thickness: 0.049" (1.2 mm)
- Spacing: 12", 18" or 24"
- Lengths: 100', 250', and 500' coils
- Use with XF Dripline Insert Fittings (see page 131), Rain Bird Easy Fit Compression Fittings (see page 132) and 17mm Insert Fittings



XFD Dripline



Available in Purple for Non-Potable water



XFD Dripline Offers Improved Flexibility for Kink Resistance and Easy Installation. The Dripline Can Bend Down to a 3" Radius Without Kinking.

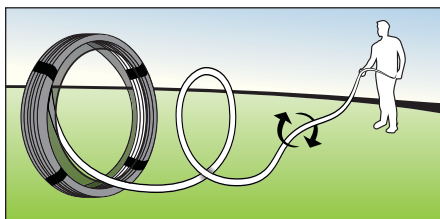

Self-Dispensing Coil Reduces Layout Time and Improves Ease of Installation



XFD Dripline

How To Specify

XFD - P - 09 - 12 - 100	
Model XFD Dripline	Length of Tubing 100 = 100' (30.5 m) 250 = 250' (76.2 m) 500 = 500' (152.4 m)
Optional Purple	Emitter Spacing 12 = 12" (30.5 cm) 18 = 18" (45.7 cm) 24 = 24" (61.0 cm)
	Flow Rate 06 = .61 gph (2.3 l/h) 09 = .92 gph (3.5 l/h) 04 = .42 gph (1.5 l/h)

XFD On-Surface Dripline Models			
Model	Flow gph	Spacing in.	Coil Length ft.
XFD-04-12-100	0.42	12	100
XFD-04-12-500	0.42	12	500
XFD-04-18-100	0.42	18	100
XFD-04-18-500	0.42	18	500
XFD-06-12-100	0.60	12	100
XFD-06-12-250	0.60	12	250
XFD-06-12-500	0.60	12	500
XFD-06-18-100	0.60	18	100
XFD-06-18-250	0.60	18	250
XFD-06-18-500	0.60	18	500
XFD-09-12-100	0.90	12	100
XFD-09-12-250	0.90	12	250
XFD-09-12-500	0.90	12	500
XFD-09-18-100	0.90	18	100
XFD-09-18-250	0.90	18	250
XFD-09-18-500	0.90	18	500
XFD-09-24-500	0.90	24	500
XFDP-04-12-500 (Purple)	0.42	12	500
XFDP-04-18-500 (Purple)	0.42	18	500
XFDP-06-12-500 (Purple)	0.60	12	500
XFDP-06-18-500 (Purple)	0.60	18	500
XFDP-09-12-500 (Purple)	0.90	12	500
XFDP-09-18-500 (Purple)	0.90	18	500

XFD On-Surface Dripline Models			METRIC
Model	Flow l/h	Spacing cm	Coil Length m
XFD-04-12-100	1.60	30.5	250
XFD-04-12-500	1.60	30.5	250
XFD-04-18-100	1.60	45.7	250
XFD-04-18-500	1.60	45.7	250
XFD-06-12-100	2.30	30.5	30.5
XFD-06-12-250	2.30	30.5	76.5
XFD-06-12-500	2.30	30.5	152.9
XFD-06-18-100	2.30	45.7	30.5
XFD-06-18-250	2.30	45.7	76.5
XFD-06-18-500	2.30	45.7	152.9
XFD-09-12-100	3.50	30.5	30.5
XFD-09-12-250	3.50	30.5	76.5
XFD-09-12-500	3.50	30.5	152.9
XFD-09-18-100	3.50	45.7	30.5
XFD-09-18-250	3.50	45.7	76.5
XFD-09-18-500	3.50	45.7	152.9
XFD-09-24-500	3.50	61.0	152.9
XFDP-04-12-500 (Purple)	1.60	30.5	152.9
XFDP-04-18-500 (Purple)	1.60	45.7	152.9
XFDP-06-12-500 (Purple)	2.30	30.5	152.9
XFDP-06-18-500 (Purple)	2.30	45.7	152.9
XFDP-09-12-500 (Purple)	3.50	30.5	152.9
XFDP-09-18-500 (Purple)	3.50	45.7	152.9

XFD On-Surface Dripline Maximum Lateral Lengths (Feet)								
Inlet Pressure psi	Maximum Lateral Length (feet)							
	12" Spacing			18" Spacing			24" Spacing	
	Nominal Flow (gph):			Nominal Flow (gph):			Nominal Flow (gph):	
	0.42	0.6	0.9	0.42	0.6	0.9	0.6	0.9
15	352	273	155	374	314	250	424	322
20	399	318	169	417	353	294	508	368
30	447	360	230	481	413	350	586	414
40	488	395	255	530	465	402	652	474
50	505	417	285	610	528	420	720	488
60	573	460	290	734	596	455	780	514

XFD On-Surface Dripline Maximum Lateral Lengths (Meters)								METRIC
Inlet Pressure bar	Maximum Lateral Length (Meters)							
	30.5 cm			45.7 cm			61.0 cm	
	Nominal Flow (l/h):			Nominal Flow (l/h):			Nominal Flow (l/h):	
	1.6	2.3	3.4	1.6	2.3	3.4	2.3	3.4
1.0	107.2	83.2	47.2	114	95.7	76.2	129.2	98.2
1.4	121.6	96.9	51.5	127.1	107.6	89.6	154.8	112.2
2.1	136.2	109.7	70.1	146.6	125.9	106.7	178.6	123.2
2.8	148.7	120.4	77.7	161.5	141.7	122.5	198.7	144.5
3.5	153.9	127.1	86.9	185.9	160.9	128.0	219.5	148.7
4.1	174.6	140.2	88.4	223.7	181.7	138.7	237.7	156.7

XFD On-Surface Dripline Flow(per 100 Feet of Tubing)					
Emitter Spacing	0.42 gph Emitter		0.6 gph Emitter		0.9 gph Emitter
12"	42.0 gph	0.70 gpm	61.0 gph	1.02 gpm	92.0 gph 1.53 gpm
18"	28.0 gph	0.47 gpm	41.0 gph	0.68 gpm	61.0 gph 1.02 gpm
24"	----- gph	----- gpm	31.0 gph	0.51 gpm	46.0 gph 0.77 gpm

XFD On-Surface Dripline Flow(per 100 Meters of Tubing)					
Emitter Spacing	1.6 l/h Emitter		2.3 l/h Emitter		3.4 l/h Emitter
0.30 meter	531.1 l/h	8.85 l/m	757.9 l/h	12.6 l/m	1136.7 l/h 18.9 l/m
0.46 meter	351.8 l/h	5.86 l/m	502.2 l/h	8.4 l/m	741.3 l/h 12.4 l/m
0.61 meter	----- l/h	----- l/m	378.7 l/h	6.3 l/m	559.0 l/h 9.3 l/m

XFCV Dripline with Heavy-Duty Check Valve

NEW

Rain Bird® XFCV Dripline with a heavy-duty 3.5 psi check valve for on-surface applications adds a valuable member to the Rain Bird XF Series of Dripline. The XFCV is the most effective dripline in the industry and is ideal for areas where no other dripline will work. When used in applications where elevation changes exist, the patent-pending check valve keeps the dripline charged, holding 8 feet of hold back. Rain Bird's XFCV offers better uniformity and helps to prevent over-watering at the low-point in the zone, avoiding puddling and water draining from the dripline.

It accepts Rain Bird Easy Fit Compression Fittings, XF Dripline Barbed Insert Fittings and other 17 mm barbed insert fittings.

Features

Simple

- Rain Bird's patent-pending 3.5 psi check valve technology keeps the dripline charged with water at all times, increasing uniformity of watering, and conserves water by eliminating the need to recharge the line at the beginning of each watering cycle
- Through the use of a proprietary tubing material, the XFCV Dripline with heavy-duty check valve is the most flexible dripline tubing in the industry, making it the easiest dripline to design with and install
- It accepts Rain Bird Easy Fit Compression Fittings, XF Dripline Barbed Insert Fittings and other 17 mm barbed insert fittings
- Rain Bird's low-profile emitter design reduces in-line pressure loss, allowing longer lateral runs, simplifying design and reducing installation time
- Variety of emitter flow rates, emitter spacing and coil lengths provide design flexibility for on-surface areas with or without elevation changes

Made with Recycled Content

- All Rain Bird XF Dripline (XFD, XFS, XFCV) qualify for LEED credit 4.2 because they contain at least 20% Polyethylene post consumer recycled material by cost. These come in an assortment of coil sizes, flow rates and emitter spacing

Reliable

- The pressure-compensating emitter design provides a consistent flow over the entire lateral length ensuring higher uniformity for increased reliability in the pressure range of 20 to 60 psi

Durable

- Dual-layered tubing (brown over black) provides unmatched resistance to chemicals, algae growth and UV damage

Grit Tolerant

- Rain Bird's proprietary emitter design resists clogging by use of an extra wide flow path combined with a self-flushing action



XFCV Dripline for Elevated Applications

With XFCV's built-in 3.5 check valve, all lines are kept charged and up to 8 feet of water is held back

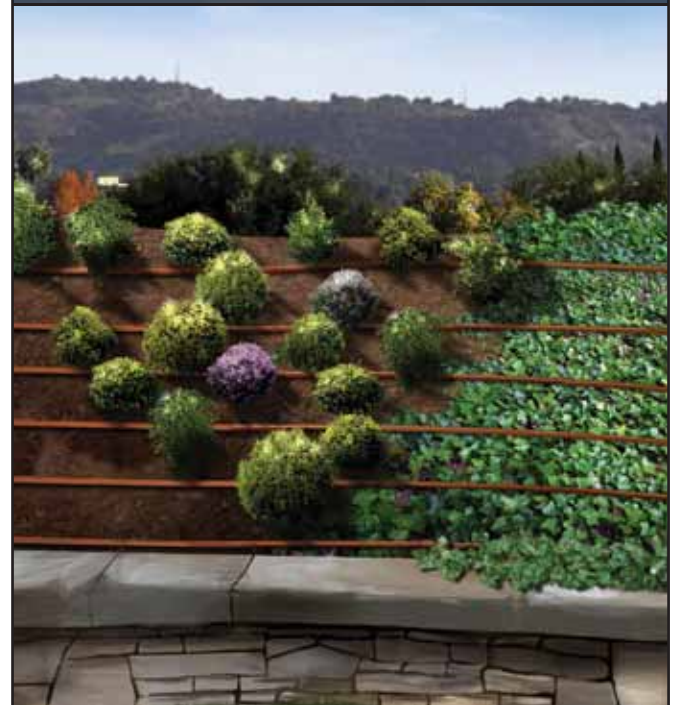

Landscape Drip

How To Specify

XFCV - 06 - 12 - 100

Model XFCV Dripline with Heavy-Duty Check Valve	Length of Tubing 100 = 100' (30.5 m) 500 = 500' (152.4 m)
	Emitter Spacing 12 = 12" (30.5 cm) 18 = 18" (45.7 cm)
Flow Rate	06 = .61 gph (2.3 l/h) 09 = .92 gph (3.5 l/h)

Operating Range

- Opening Pressure: 14.5 psi
- Pressure: 20 to 60 psi (1.38 to 4.14 bar)
- Flow rates: 0.6 and 0.9 gph (2.3 l/hr and 3.5 l/hr)
- Temperature:
 - Water: Up to 100°F (37.8° C)
 - Ambient: Up to 125°F (51.7° C)
- Required Filtration: 120 mesh

Specifications

- Dimensions:
 - OD: 0.634" (16mm)
 - ID: 0.536" (13.6mm);
- Thickness: 0.049" (1.2mm)
- 12" & 18" (30.5 cm, 45.7 cm) spacing
- Available in 100' and 500' (30.5 m and 152.4 m) coils
- Coil Color: Brown
- Use with XF Dripline Insert Fittings (see page 131), Rain Bird Easy Fit Compression Fittings (see page 132) and 17mm Insert Fittings

XFCV Dripline Models			
Model	Flow gph	Spacing in.	Coil Length ft.
XFCV-06-12-100	0.60	12	100
XFCV-06-12-500	0.60	12	500
XFCV-06-18-100	0.60	18	100
XFCV-06-18-500	0.60	18	500
XFCV-09-12-100	0.90	12	100
XFCV-09-12-500	0.90	12	500
XFCV-09-18-100	0.90	18	100
XFCV-09-18-500	0.90	18	500

XFCV Dripline Models			METRIC
Model	Flow l/h	Spacing cm	Coil Length m
XFCV-06-12-100	2.30	30.5	30.5
XFCV-06-12-500	2.30	30.5	152.4
XFCV-06-18-100	2.30	45.7	30.5
XFCV-06-18-500	2.30	45.7	152.4
XFCV-09-12-100	3.50	30.5	30.5
XFCV-09-12-500	3.50	30.5	152.4
XFCV-09-18-100	3.50	45.7	30.5
XFCV-09-18-500	3.50	45.7	152.4

XFCV Dripline Maximum Lateral Lengths (Feet)				
Inlet Pressure psi	Maximum Lateral Length (feet)			
	12" Spacing		18" Spacing	
	Nominal Flow (gph):		Nominal Flow (gph):	
	0.6	0.9	0.6	0.9
20	276	180	306	255
30	336	215	385	326
40	377	269	444	383
50	411	293	509	405
60	450	320	583	445

XFCV Dripline Maximum Lateral Lengths (Meters)				
Inlet Pressure bar	Maximum Lateral Length (Meters)			
	30.5 cm		45.7 cm	
	Nominal Flow (l/h):		Nominal Flow (l/h):	
	2.3	3.5	2.3	3.5
1.38	84	45	93	78
2.07	102	65	117	99
2.76	115	74	135	117
3.45	125	84	155	123
4.14	137	86	178	136

XFS Sub-Surface Dripline with Copper Shield™ Technology

Sub-Surface Drip Irrigation (SDI) perfect for small, narrow and tight planting areas, switchbacks, as well as all turf landscapes

Rain Bird® XFS Sub-Surface Copper-Colored Dripline with Copper Shield™ Technology is the latest innovation in the Rain Bird Xerigation® Family. Rain Bird's patent-pending Copper Shield Technology protects the emitter from root intrusion, creating a long-lasting, low maintenance sub-surface drip irrigation system for use under turf grass or shrub and groundcover areas.

A proprietary tubing material makes the XFS Sub-Surface Dripline with Copper Shield the most flexible tubing in the industry, and the easiest sub-surface dripline to design with and install.

It accepts Rain Bird's Easy Fit Compression Fittings, XF Dripline Fittings and other 17 mm insert fittings.

Features

Simple

- Rain Bird's low-profile emitter design reduces in-line pressure loss, allowing longer lateral runs, simplifying design and reducing installation time
- Variety of emitter flow rates, emitter spacing and coil lengths provide design flexibility for either sub-surface turf or sub-surface shrub and groundcover applications

Reliable

- XFS Sub-Surface Dripline emitters are protected from root intrusion by Rain Bird's patent-pending Copper Shield™ Technology resulting in a system that does not require maintenance or replacement of chemicals to prevent root intrusion
- The pressure-compensating emitter design provides a consistent flow over the entire lateral length ensuring higher uniformity for increased reliability in the pressure range of 8.5 to 60 psi

Durable

- Dual-layered tubing (copper over black) provides unmatched resistance to chemicals, algae growth and UV damage
- Grit Tolerant: Rain Bird's proprietary emitter design resists clogging by use of an extra-wide flow path combined with a self-flushing action

Operating Range

- Pressure: 8.5 to 60 psi (0.58 to 4.14 bar)
- Flow rates: 0.4 gph, 0.6, and 0.9 gph (1.6 l/h, 2.3 l/hr and 3.5 l/hr)
- Temperature:
 - Water: Up to 100°F (37.8° C)
 - Ambient: Up to 125°F (51.7° C)
- Required Filtration: 120 mesh

Specifications

- Dimensions: OD: 0.634" (16mm); ID: 0.536" (13.6mm); Thickness: 0.049" (1.2mm)
- 12", 18", 24" (30.5 cm, 45.7 cm, 61.0 cm) spacing
- Available in 100' and 500' (30.5 m and 152.4 m) coils
- Coil Color: Copper



XFS Sub-Surface Dripline



Irrigation Association Show Winner



XFS Dripline offers increased flexibility for easy installation

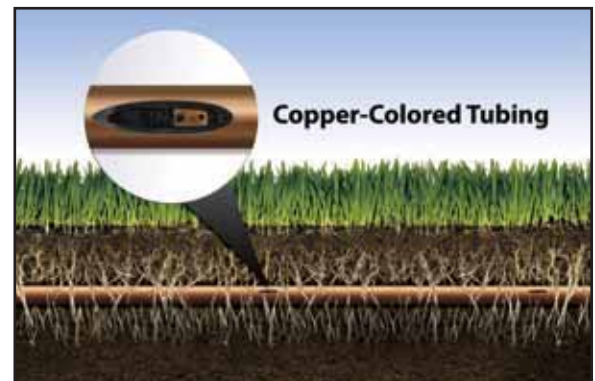

XFS Sub-Surface Dripline with Copper Shield™ Technology

How To Specify

XFS - P - 09 - 12 - 100	
Optional P = Purple over black	Length of Tubing 100 = 100' (30.5 m) 500 = 500' (152.4 m)
Model XFS Sub-Surface Dripline	Emitter Spacing 12 = 12" (30.5 cm) 18 = 18" (45.7 cm) 24 = 24" (61.0 cm)
	Flow Rate 04 = 42 gph (1.6 l/h) 06 = 61 gph (2.3 l/h) 09 = 92 gph (3.5 l/h)

XFS Sub-Surface Dripline Models			
Model	Flow gph	Spacing in.	Coil Length ft.
XFS-04-12-100	0.42	12	100
XFS-04-12-500	0.42	12	500
XFS-04-18-100	0.42	18	100
XFS-04-18-500	0.42	18	500
XFS-06-12-100	0.60	12	100
XFS-06-12-500	0.60	12	500
XFS-06-18-100	0.60	18	100
XFS-06-18-500	0.60	18	500
XFS-06-24-500	0.60	24	500
XFS-09-12-100	0.90	12	100
XFS-09-12-500	0.90	12	500
XFS-09-18-100	0.90	18	100
XFS-09-18-500	0.90	18	500
XFSP-04-12-500 (Purple)	0.42	12	500
XFSP-04-18-500 (Purple)	0.42	18	500
XFSP-06-12-500 (Purple)	0.60	12	500
XFSP-06-18-500 (Purple)	0.60	18	500
XFSP-09-12-500 (Purple)	0.90	12	500
XFSP-09-18-500 (Purple)	0.90	18	500

XFS Sub-Surface Dripline Models				METRIC
Model	Flow l/h	Spacing cm	Coil Length m	
XFD-04-12-100	1.60	30.5	250	
XFD-04-12-500	1.60	30.5	250	
XFD-04-18-100	1.60	45.7	250	
XFD-04-18-500	1.60	45.7	25	
XFS-06-12-100	2.30	30.5	30.5	
XFS-06-12-500	2.30	30.5	152.9	
XFS-06-18-100	2.30	45.7	30.5	
XFS-06-18-500	2.30	45.7	152.9	
XFS-06-24-500	2.30	61.0	152.9	
XFS-09-12-100	3.50	30.5	30.5	
XFS-09-12-500	3.50	30.5	152.9	
XFS-09-18-100	3.50	45.7	30.5	
XFS-09-18-500	3.50	45.7	152.9	
XFSP-04-12-500 (Purple)	1.60	30.5	152.9	
XFSP-04-18-500 (Purple)	1.60	45.7	152.9	
XFSP-06-12-500 (Purple)	2.30	30.5	152.9	
XFSP-06-18-500 (Purple)	2.30	45.7	152.9	
XFSP-09-12-500 (Purple)	3.50	30.5	152.9	
XFSP-09-18-500 (Purple)	3.50	45.7	152.9	

XFS Sub-Surface Dripline Maximum Lateral Lengths (Feet)									
Inlet Pressure psi	Maximum Lateral Length (feet)								
	12" Spacing			18" Spacing			24" Spacing		
	Nominal Flow (gph):			Nominal Flow (gph):			Nominal Flow (gph):		
	0.42	0.6	0.9	0.42	0.6	0.9	0.6	0.9	
15	352	273	155	374	314	250	424	322	
20	399	318	169	417	353	294	508	368	
30	447	360	230	481	413	350	586	414	
40	488	395	255	530	465	402	652	474	
50	505	417	285	610	528	420	720	488	
60	573	460	290	734	596	455	780	514	

XFS Sub-Surface Dripline Maximum Lateral Lengths (Meters)										METRIC
Inlet Pressure bar	Maximum Lateral Length (Meters)									
	30.5 cm			45.7 cm			61.0 cm			
	Nominal Flow (l/h):			Nominal Flow (l/h):			Nominal Flow (l/h):			
	1.6	2.3	3.4	1.6	2.3	3.4	2.3	3.4		
1.0	107.2	83.2	47.2	114	95.7	76.2	129.2	98.2		
1.4	121.6	96.9	51.5	127.1	107.6	89.6	154.8	112.2		
2.1	136.2	109.7	70.1	146.6	125.9	106.7	178.6	123.2		
2.8	148.7	120.4	77.7	161.5	141.7	122.5	198.7	144.5		
3.5	153.9	127.1	86.9	185.9	160.9	128.0	219.5	148.7		
4.1	174.6	140.2	88.4	223.7	181.7	138.7	237.7	156.7		

XFS Sub-Surface Dripline Flow(per 100 Feet of Tubing)						
Emitter Spacing	0.42 gph Emitter		0.6 gph Emitter		0.9 gph Emitter	
12"	42.0 gph	0.70 gpm	61.0 gph	1.02 gpm	92.0 gph	1.53 gpm
18"	28.0 gph	0.47 gpm	41.0 gph	0.68 gpm	61.0 gph	1.02 gpm
24"	----- gph	----- gpm	31.0 gph	0.51 gpm	46.0 gph	0.77 gpm

XFS Sub-Surface Dripline Flow(per 100 Meters of Tubing)						
Emitter Spacing	1.6 l/h Emitter		2.3 l/h Emitter		3.4 l/h Emitter	
0.30 meter	531.1 l/h	8.85 l/m	757.9 l/h	12.6 l/m	1136.7 l/h	18.9 l/m
0.46 meter	351.8 l/h	5.86 l/m	502.2 l/h	8.4 l/m	741.3 l/h	12.4 l/m
0.61 meter	----- l/h	----- l/m	378.7 l/h	6.3 l/m	559.0 l/h	9.3 l/m

Landscape Drip

XF Dripline Insert Fittings

Features

- Complete line of 17mm insert fittings to simplify installation of XF Series Dripline
- High quality barbs grab tubing for a secure fit
- Unique barb design to reduce insertion force and still retain a secure fit
- Non-obtrusive colored fittings to compliment natural earth tones

Operating Range

- Pressure: 0 to 50 psi (1.0 to 3.5 bar) if using 60 psi (4.1 bar) clamps will be required

Models

- XFF-COUP: 17mm Barb x Barb Coupling
- XFF-ELBOW: 17mm Barb x Barb Elbow
- XFF-MA-050: 17mm Barb x 1/2" MPT Male Adapter
- XFF-TEE: 17mm Barb x Barb x Barb Tee
- XFF-TMA-050: 17mm Barb x 1/2" MPT x 17mm Barb Tee Male Adapter
- XFF-MA-075: 17mm Barb x 3/4" MPT Male Adapter
- XFD-CROSS: Barb cross 17mm x 17mm x 17mm x 17mm
- XFD-TFA-075: Barb tee female adapter 17mm x 3/4" FPT x 17mm
- LD16STK: 7 3/4" barbed tubing plastic stake
- FITINS-TOOL: XF Fitting Insertion Tool. Compatible with XFF-COUP, XFF-ELBOW, and XFF-TEE



FITINS-TOOL

Easy Fit Compression Fitting System

Complete system of compression fittings and adapters for all tubing connection needs in a low-volume system

Features

- Reduces inventory costs: Multi-diameter compression fittings work with a wide range of 16mm - 17mm tubing or dripline
- Saves time and effort: 50% less force is required to connect tubing and fittings versus competitive compression fittings. Adapters swivel for easy installation
- Provides increased flexibility: Just three Easy Fit Fittings and five Easy Fit Adapters are needed to make over 160 combinations of connections, accommodating countless installation and maintenance situations
- Works with all 16-17mm dripline and blank tubing
- Patented fittings and adapters are molded from UV-resistant and durable ABS materials
- Removable flush caps can be used to flush end of line and temporarily cap off lines for later expansion

Operating Range

- Pressure: 0 to 60 psi (0 to 4.1 bar)
- Accepts tubing O.D. of 0.630" to 0.669" (16-17mm)

Models

• Easy Fit Fittings

- MDCFCOUP: Coupling
- MDCFEL: Elbow
- MDCFTEE: Tee

• Easy Fit Adapters

- MDCF50MPT: 1/2" Male Pipe Thread Adapter
- MDCF75MPT: 3/4" Male Pipe Thread Adapter
- MDCF50FPT: 1/2" Female Pipe Thread Adapter
- MDCF75FPT: 3/4" Female Pipe Thread Adapter
- MDCF75FHT: 3/4" Female Hose Thread Adapter
- MDCFAP: Removable Flush Cap For Easy Fit Fittings (Black)
- MDCFPCAP: Removable Flush Cap For Easy Fit Fittings (Purple, to designate non-potable water)

Note: Easy Fit Adapters are not barbed fittings
They are to be used only with Easy Fit Compression Fittings

Friction Loss per Fitting			
Flow gpm	Loss psi	METRIC	
		Flow l/h	Loss bar
0.00	0.00	0.00	0.00
1.00	0.39	227.1	0.03
2.00	0.64	454.3	0.04
3.00	0.82	681.4	0.06
4.00	1.45	908.5	0.10
5.00	1.90	1135.6	0.13
6.00	2.57	1362.8	0.18

Note: Use of fittings at flows shown in dark shaded area is not recommended.



XF Series Blank Tubing

Features:

- Greater flexibility is easier to install and saves time
- Brown color matches landscape and blends with mulch. Matches XF Series Dripline inline emitter tubing
- Compatible with XF Series Dripline (0.536" I.D. x 0.634" O.D.)
- Accepts Rain Bird Easy Fit Compression Fittings, XF Dripline Insert Fittings, and 17mm insert fittings
- Not compatible with 16 mm fittings

Specifications

- Outside Diameter: 0.634" (16.1mm)
- Inside Diameter: 0.536" (13.6mm)
- Wall Thickness: 0.049" (1.2mm)



XF100

Models:

- XFD100: 100 ft. coil (30m)
- XFD250: 250 ft. coil (76m)
- XFD500: 500 ft. coil (152m)

Tubing Friction Loss Characteristics

O.D. .634" I.D. .536"			O.D. 16.1mm I.D. 13.6mm METRIC		
Flow gpm	Velocity fps	Loss psi	Flow l/h	Velocity m/s	Loss bar
0.50	0.70	0.27	113.56	0.21	0.06
1.00	1.40	0.97	227.12	0.43	0.22
1.50	2.10	2.06	340.69	0.64	0.46
2.00	2.80	3.50	454.25	0.85	0.79
2.50	3.50	5.29	567.81	1.07	1.20
3.00	4.20	7.42	681.37	1.28	1.68
3.50	4.90	9.87	794.94	1.49	2.23
4.00	5.60	2.64	908.50	1.71	2.86
4.50	6.30	15.72	1022.06	1.92	3.56
5.00	7.00	19.11	1135.62	2.13	4.32
5.50	7.70	22.80	1249.19	2.35	5.16
6.00	8.40	26.78	1362.75	2.56	6.06

Psi Loss Per 100 Feet of Pipe (psi/100ft.)

bar Loss per 100 Meters of Pipe (bar/100m)

Note: Use of tubing at flows shown in dark shaded area is not recommended, as velocities exceed 5 ft/sec (1.5 m/s)

XT-700 Distribution Tubing

Durable, thick-walled distribution tubing stands up to harsh conditions and performs well in all climates

Features

- Thick-walled, flexible tubing resists kinks and damage caused by routine landscape maintenance activities
- Extruded from UV-resistant polyethylene resin materials

Operating Range

- Pressure: 0 to 60 psi (0 to 4.1 bar)

Specifications

- Outside diameter: 0.700" (18 mm)
- Inside diameter: 0.580" (15 mm)
- Wall thickness: 0.06" (1.5 mm)



XT-700-100

Models

- XT-700-100: 100-foot coil (30 m)
- XT-700-500: 500-foot coil (152 m)

Note: For both water conservation and appearance, it is recommended that a 2" to 3" (5 to 8 cm) mulch cover be placed on top of the tubing

XT-700 Tubing Friction Loss Characteristics

O.D. .700" I.D. .580"			O.D. 18 mm I.D. 15 mm METRIC			
Flow gpm	Velocity fps	Loss psi	Flow m ³ /h	Flow l/h	Velocity m/s	Loss bar
0.50	0.61	0.19	0.11	0.03	0.19	0.01
1.00	1.21	0.69	0.23	0.06	0.37	0.05
1.50	1.82	1.45	0.34	0.09	0.56	0.10
2.00	2.43	2.47	0.45	0.13	0.74	0.17
2.50	3.03	3.74	0.57	0.16	0.92	0.26
3.00	3.64	5.24	0.68	0.19	1.11	0.36
3.50	4.24	6.97	0.79	0.22	1.29	0.48
4.00	4.85	8.93	0.91	0.25	1.48	0.62
4.50	5.46	11.10	1.02	0.28	1.67	0.77
5.00	6.06	13.50	1.14	0.32	1.85	0.93
5.50	6.67	16.10	1.25	0.35	2.03	1.11
6.00	7.28	18.92	1.36	0.38	2.22	1.31

Psi Loss per 100 Feet of Pipe (psi/100ft.) bar Loss per 100 Meters of Pipe (bar/100m)

Note: Use of tubing at flows shown in dark shaded area is not recommended, as velocities exceed 5 ft/sec (1.5 m/s)

XF Series Dripline Insert Adapter for 1", 1½" or larger PVC

- Connects XF Series Dripline and Blank Tubing to PVC mainlines at low pressures
- UV stabilized for long life
- Easy-to-use Ratchet Clamp secures tubing to adapter

Model

- XFPVCADP: Adaptor for use with 1" PVC pipe
- XFPVCBIT: Drill bit for use with XFPVCADP 1" adapter **NEW**
- XFDINPVC: Adaptor for use with 1 1/2" PVC pipe or larger **NEW**

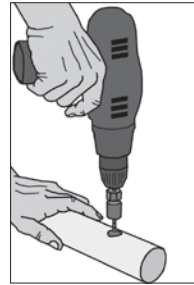

Drill hole using 5/8" hole saw size.* Use low speed drill. Remove burrs from hole

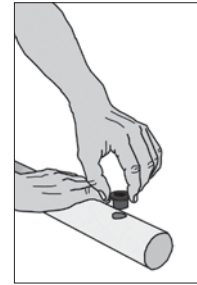

Remove shavings and place appropriate grommet firmly in hole with flange facing out

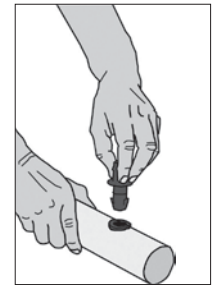

Push XF Series Dripline Insert Adapter into grommet until flange and grommet are flush



* XFPVCBIT drill bit should be used for drilling holes for the XFPVCADP 1" Adapter. Bit to be used in PVC or PE pipe only. Not suitable for any other materials.



Air/Vacuum Relief Valve Kit

Features

- Use with Rain Bird XF-Series or Landscape Dripline inline emitter tubing when installation is below soil*
- Made of quality rust-proof materials
- Fits inside an SEB 7XB emitter box

*Rain Bird recommends XFS dripline with Copper Shield™ for subsurface installations, including installations under turf grass.

Model

- ARV050: ½" Air Relief Valve



Maximum Length of Dripline Useable with the ARV		
1/2" ARV		
Emitter Spacing	0.6 GPH	0.9 GPH
12"	639'	424'
18"	958'	636'
24"	1278'	848'
ARV Capacity		
Total Flow (GPM)	6.5	
Total Flow (GPH)	390	

Maximum Length of Dripline Useable with the ARV			METRIC
1/2" ARV			
Emitter Spacing	2.3 l/h	3.4 l/h	
0.30 m	195	129	
0.46 m	292	194	
0.61 m	390	258	
ARV Capacity			
Total Flow (l/m)	24.6		
Total Flow (l/h)	1476		

Install Air/Vacuum Relief Valves correctly by:

Locate at the highest point(s) of the dripline zone. Install the valve in an exhaust header or a line that runs perpendicular to the lateral rows to ensure all rows of the dripline can take advantage of the air/vacuum relief valve

Drip System Operation Indicator

Features

- Stem rises 6" for clear visibility
- When stem is extended, drip system is charged to a minimum of 20 psi
- VAN Nozzle is tightened to no flow but can be opened to observe wetting pattern
- Includes 16" of ¼" distribution tubing with connection fitting pre-installed

Model

- OPERIND



XBS - Black Stripe Tubing

High quality, flexible tubing for use in any low-volume irrigation system

Features

- 1/2" & 3/4" blank tubing extruded from polyethylene resin materials for consistent durability
- Available in five color stripes to differentiate zones
- UV-resistant for installations at or below grade
- Compact coils for easy storage and shipping

Specifications

1/2" Tubing Models

- Outside diameter: 0.705" (18 mm)
- Inside diameter: 0.615" (15.6 mm)
- Wall thickness: 0.045" (1.2 mm)
- Lengths: 500' coils

3/4" Tubing Models

- Outside diameter: 0.940" (24 mm)
- Inside diameter: 0.820" (21 mm)
- Wall thickness: 0.060" (1.5 mm)
- Lengths: 500' coils only

Operating Range

- Pressure: 0 to 60 psi (0 to 4.1 bar)

Models

1/2" Models

- XBS100: 1/2" tubing, 100 foot (30 m) coil with green striping
- XBS500: 1/2" tubing, 500 foot (152 m) coil with green striping
- XBS100B: 1/2" tubing, 100 foot (30 m) coil with black striping
- XBS500B: 1/2" tubing, 500 foot (152 m) coil with black striping
- XBS500R: 1/2" tubing, 500 foot (152 m) coil with red striping
- XBS500Y: 1/2" tubing, 500 foot (152 m) coil with yellow striping
- XBS500P: 1/2" tubing, 500 foot (152 m) coil with purple striping

3/4" Tubing Models

- XBS075500G: 3/4" tubing, 500 foot (152 m) coil with green striping
- XBS075500P: 3/4" tubing, 500 foot (152 m) coil with purple striping

1/2" XBS - Tubing Friction Loss Characteristics

O.D. .705" I.D. .615"			O.D. 18 mm I.D. 15.5 mm METRIC			
Flow gpm	Velocity fps	Loss psi	Flow m ³ /h	Flow l/h	Velocity m/s	Loss bar
0.50	0.54	0.14	0.11	113.6	0.16	0.03
1.00	1.08	0.52	0.23	227.1	0.33	0.12
1.50	1.62	1.09	0.34	340.7	0.49	0.25
2.00	2.16	1.86	0.45	454.3	0.66	0.42
2.50	2.70	2.81	0.57	567.8	0.82	0.64
3.00	3.24	3.94	0.68	681.4	0.99	0.89
3.50	3.78	5.24	0.79	794.9	1.15	1.19
4.00	4.31	6.71	0.91	908.5	1.32	1.52
4.50	4.85	8.35	1.02	1022.1	1.48	1.89
5.00	5.39	10.15	1.14	1135.6	1.64	2.30
5.50	5.93	12.11	1.25	1249.2	1.81	2.74
6.00	6.47	14.22	1.36	1362.8	1.97	3.22

3/4" XBS - Tubing Friction Loss Characteristics

OD .940" ID .820"			OD 23.9mm ID 20.8mm METRIC			
Flow gpm	Velocity fps	Loss psi	Flow m ³ /h	Flow l/h	Velocity m/s	Loss bar
0.50	0.30	0.03	0.11	113.6	0.09	0.01
1.00	0.61	0.11	0.23	227.1	0.19	0.03
1.50	0.91	0.24	0.34	340.7	0.28	0.05
2.00	1.22	0.40	0.45	454.2	0.37	0.09
2.50	1.52	0.61	0.57	567.8	0.46	0.14
3.00	1.82	0.86	0.68	681.4	0.56	0.19
3.50	2.13	1.14	0.79	794.9	0.65	0.26
4.00	2.43	1.46	0.91	908.5	0.74	0.33
4.50	2.74	1.81	1.02	1022.1	0.83	0.41
5.00	3.04	2.20	1.14	1135.6	0.93	0.50
5.50	3.34	2.63	1.25	1249.2	1.02	0.59
6.00	3.65	3.09	1.36	1362.7	1.11	0.70
6.50	3.95	3.58	1.48	1476.3	1.20	0.81
7.00	4.25	4.11	1.59	1589.9	1.30	0.93
7.50	4.56	4.67	1.70	1703.4	1.39	1.06
8.00	4.86	5.26	1.82	1817.0	1.48	1.19
8.50	5.17	5.88	1.93	1930.6	1.57	1.33
9.00	5.47	6.54	2.04	2044.1	1.67	1.48
9.50	5.77	7.23	2.16	2157.7	1.76	1.64
10.0	6.08	7.95	2.27	2271.2	1.85	1.80

Psi Loss Per 100 Feet of Pipe (psi/100ft.) bar Loss per 100 Meters of Pipe (bar/100m)
Note: Use of tubing at flows shown in dark shaded area is not recommended, as velocities exceed 5 ft/sec (1.5 m/s)



Black Stripe Tubing

XQ ¼" Distribution Tubing

The strongest and most flexible ¼" Distribution Tubing available to extend emitter outlets to desirable discharge locations

Features

- Unique blend of polymers that give it the flexibility of vinyl with hold of poly
- New textured finish improves handling
- Self extracting coiling feature makes it easy to use, store and eliminates waste
- Fits over barbed outlet ports and all Xerigation emission devices and ¼" transfer fittings
- Extruded from UV-resistant polyethylene resin materials

Specifications

- Outside Diameter: 0.25" (6.3 mm) • Wall Thickness: .04" (1.0 mm)
- Inside Diameter: 0.17" (4.3 mm) • Lengths: 100' and 1000' coils

Operating Range

- Pressure: 0 to 60 psi (0 to 4.1 bar)

Models

- XQ-100: 100-foot (30m) coil ¼" distribution tubing
- XQ-1000: 1000-foot (305m) coil ¼" distribution tubing
- XQ-1000-B: 1000-foot (305m) coil ¼" distribution tubing in a bucket

XQ ¼" Distribution Tubing Friction Loss Characteristics

O.D. .25" I.D. .17"			O.D. 6.3mm I.D. 4.3mm METRIC			
Flow gph	Velocity fps	Loss psi	Flow m³/h	Flow l/h	Velocity m/s	Loss bar
1	0.27	0.16	0.00	3.79	0.08	0.01
3	0.80	1.24	0.01	11.6	0.24	0.09
5	1.33	3.20	0.02	18.92	0.41	0.22
7	1.86	5.97	0.03	26.50	0.57	0.41
9	2.39	9.50	0.03	34.07	0.73	0.66
11	2.92	13.79	0.04	41.64	0.89	0.95
13	3.45	18.75	0.05	49.21	1.05	1.29
15	3.98	24.43	0.06	56.78	1.21	1.69
17	4.52	30.80	0.06	64.35	1.38	2.13
18	4.78	34.23	0.07	68.13	1.46	2.36
19	5.05	37.83	0.07	71.92	1.54	2.61
20	5.31	41.60	0.08	75.70	1.62	2.87
25	6.64	62.86	0.09	94.63	2.03	4.34
30	7.97	88.08	0.11	113.55	2.43	6.08

psi Loss Per 100 Feet of tubing; C=150 bar Loss per 100 Meters of tubing

Note: Use of tubing at flows shown in dark shaded area is not recommended, as velocities exceed 5 ft/sec (1.5 m/s)



XQ-100 and XQ-1000 ¼" Tubing



XQ-1000-B ¼" Tubing

¼" Landscape Dripline

Rain Bird ¼" Dripline is a perfect choice for small-sized areas such as planter boxes, container gardens, loops around trees, vegetable gardens and shrubs

Features

- Simple to use, as the flexible tubing makes watering pots and container gardens easy
- Clog resistance through built-in filtration and two outlet holes, 180 degrees apart
- Brown tubing complements Rain Bird XF Dripline
- Works with Rain Bird ¼" barbed Fittings

Operating Range

- 10 to 40 psi (0.7 to 2.7 bar)
- Flow rate at 30 psi (2.0 bar): 0.8gph (3.0 l/h)
- Required filtration: 200 mesh (75 micron)

Specifications

- Outside diameter: 0.250" (6 mm)
- Inside diameter: 0.170" (4 mm)
- Wall thickness: 0.040" (1 mm)
- Spacing: 6" or 12" (15.25 cm and 30.5 cm)
- Length: 100' (30.5 m) coils



LDQ-08-06-100

Models

- LDQ0806100 • LDQ0812100

Flow Characteristics

Model	Flow at 30 psi (gph) (l/h)		Spacing (in.) (cm)		Coil Length (ft.) (m)	
LDQ0806100	0.8	3.0	6	15.25	100	30.50
LDQ0812100	0.8	3.0	12	30.5	100	30.5

¼" Landscape Dripline Performance

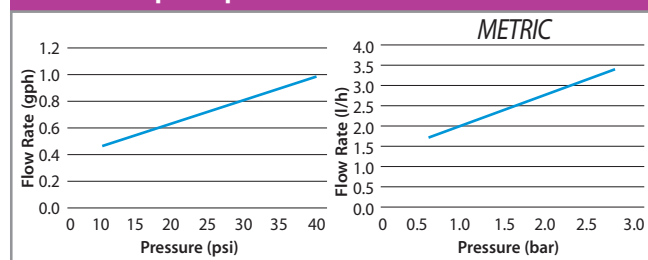

Maximum Length of Run (Feet)

Emitter Spacing	Maximum Length of Run	Flow per Ft. @ 15 psi
6"	19 feet	1 gph/ft.
12"	33 feet	0.5 gph/ft.

1/4" Barb Transfer Fittings

Features

- Used to connect 1/4" Distribution Tubing (XQ) in different configurations or attach 1/4" tubing to 1/2" or 3/4" tubing
- Newly designed connectors have self-piercing barbs that easily puncture 1/2" or 3/4" tubing
- Stem on fittings allows simple, quick installation using Xeriman™ Tool (XM-TOOL)
- Rugged plastic construction

Operating Range*

- Pressure: 0 to 50 psi (0 to 3.5 bar)
* with polyethylene tubing

Models

- XBF1CONN: 1/4" barb connector
- XBF2EL: 1/4" barb x barb elbow
- XBF3TEE: 1/4" barb x barb x barb tee



Subterranean Emitter Box

Features

- Provides convenient access to subsurface emitter while protecting against vandalism. Ideal for multi-outlet devices (such as Xeri-Bird 8) and Air Vacuum Relief Valve Kit
- New larger body allows more room for components and distribution tubing
- Rugged, UV-resistant thermoplastic construction
- Available with black top

Dimensions

- Height: 9.0" (22.9 cm)
- Top Diameter: 6.4" (16.3 cm)
- Base Diameter: 9.8" (24.9 cm)

Model

- SEB 7XB



Galvanized Tie-Down Stake

Features

- 12-gauge galvanized steel rod comes pre-bent to staple distribution tubing, XF Dripline or XBS Tubing to finished grade
- Notched sides help secure stake in ground
- Sturdy, long-lasting and corrosion-resistant

Model

- TDS-050 BEND



Tubing Goof Plug

Features

- Used to plug unwanted holes in tubing
- New design works with Xeriman™ Tool (XM-TOOL) for a quick, easy installation

Model

- EMA-GPX



Tubing Cutter

Features

- Re-designed Xerigation Tubing Cutter allows for easier and cleaner cuts of all low-volume tubing
- Unique design provides two different-sized wells (one for 1/2" - 3/4" tubing and one for 1/4" tubing); giving more leverage so less force is needed to cut any tubing
- Tubing Cutter is lightweight with stainless steel blades. Replacement blades available (PPC-200XBLD)

Model

- PPC-200X: Tubing cutter
- PPC-200XBLD: Replacement blade

Improved Dual-well
Design Allows for
Clean Cuts



Xeriman™ Tool

Features

- Provides fast, easy, one-step installation of Xeri-Bug™ emitters and PC Modules directly into ½" or ¾" drip tubing, XF Dripline or Landscape Dripline
- Cuts emitter installation time
- All-in-one tool inserts emitters, removes emitters, inserts ¼" barbed fittings and installs goof plugs

Model

- XM-TOOL



One Step
Xeri-Bug™
Insertion

Xeri-Bug™
Removal

Goof Plug
Insertion



XM-TOOL

Xeri-Caps™ for Spray Heads

Features

- Helps to retrofit a spray head system to a drip system by capping off any unused spray heads

Operating Range

- Pressure: Up to 70 psi (4.8 bar)

Dimension

- Width: 2¼" (5.7 cm)

Models

- XC-1800: fits Rain Bird 1800 Series Spray Bodies



Rain Bird® XC-1800

Spray-to-Drip Retrofit Kit

Simple kit that easily converts a conventional spray zone to a low-volume irrigation zone

Features

- 1800 Series Spray Body that contains a filter, pressure regulator, and ½" male threaded outlet
- Permits convenient conversion to drip tubing when used with Easy Fit Fitting and female adapter
 - Can be installed above or below grade
- Internal assembly can be removed and easily dropped into any 1804, 1806 or 1812 Spray Head Body to easily retrofit existing system to Xerigation products
- Provides 30 psi (2.1 bar) pressure regulation and 200-mesh (75-micron) screen
- If retrofit flow is less than 3 gpm, replace electronic valve with a Rain Bird Low Flow Valve

Operating Range

- Flow: 0.50 to 4.00 gpm (1.9 to 15.1 l/m)
- Inlet pressure: 15 to 70 psi (1.0 to 4.8 bar)
- Regulated pressure: 30 psi (2.1 bar)
- Filtration: 200 mesh (75 micron)

Model

- 1800-Retro

Dimensions

- ½" female-threaded inlet
- ½" male-threaded swivel outlet
- Height: 7" (17.8 cm)
- Width: 2" (5.1 cm)

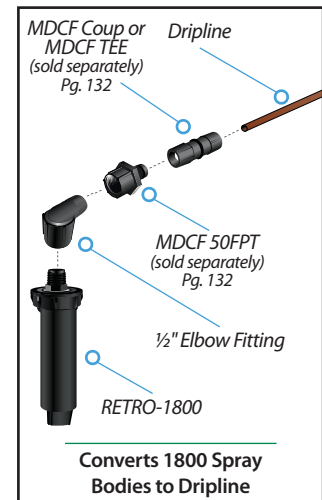
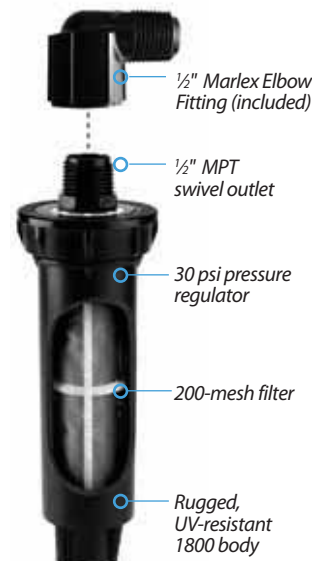

Control Zone Kit Selection Guide

This easy-to-use selection tool is available at www.rainbird.com/CZK and will help identify the most appropriate Control Zone Kit for the application.



X CZ-150-PRB-COM
FLOW: 15 - 40 gpm

FLOW: 15 - 40 gpm

Page
146



X CZ-100-PRB-COM
FLOW: 3 - 20 gpm



X CZ-100-PRB-LC
FLOW: 3 - 20 gpm



X CZ-100-PRBR
FLOW: 3 - 20 gpm

FLOW: 3 - 20 gpm

Pages
144 - 145



X CZ-100-PRF
FLOW: 3 - 15 gpm



X CZF-100-PRF
FLOW: 3 - 15 gpm



X ACZ-100-PRF
FLOW: 3 - 15 gpm



X CZF-175-PRF
FLOW: 3 - 10 gpm

FLOW: 3 - 15 gpm

3 - 10 gpm

Pages
142 - 143



X CZ-075-PRF
FLOW: 0.2 - 5 gpm



X CZ-LF-100-PRF
FLOW: 0.2 - 5 gpm



X ACZ-075-PRF
FLOW: 0.2 - 5 gpm

FLOW: 0.2 - 5 gpm

Pages
141 - 142

Online Control Zone Kit Selection Guide

Rain Bird Control Zone Kits provide all of the components necessary for on/off control, filtration and pressure regulation of a low-volume irrigation zone, making the kits simple to order and easy to install.

This quick selection tool will help you find the appropriate control zone kit for your application. By answering a few simple questions, the selection guide will provide recommended control zone kits best suited for your application. Simply click on the kit image for detailed information and specifications.

Features

- Includes detailed drawings and specifications for each kit
- Available at www.rainbird.com/CZK



Control Zone Kits

Rain Bird Control Zone Kits provide all of the components necessary for on/off control, filtration, and pressure regulation in a single package, making them simple to order and easy to install.

- Rain Bird Control Zone Kits are the most reliable kits and contain revolutionary products such as the Low Flow Valve, Pressure Regulating (PR) Filter, Quick Check Basket Filter, and the Pressure Regulating (PR) Quick Check Basket Filter
- All kits in every category use the innovative PR Filter which combines the filter and pressure regulator into one unit. The PR Filter eliminates a separate component to help avoid leaks either during installation or over the life of the kit in the field. Most PR Filter kits come assembled to save installation time and avoid in-field mistakes

- Rain Bird offers the most complete line of Control Zone Kits, giving contractors and specifiers the flexibility to meet every need from 0.2 to 40 gpm. Choose from:
 - ¾", 1" or 1½" inlet opening
 - Low Flow Valve, Anti-Siphon Valve, DV Valve, or PESB Valve
 - Pressure Regulating RBY Filter, Pressure Regulating Quick Check Basket Filter, or Quick Check Basket Filter

Use the chart below to identify the most appropriate kit or see pages 141-146 for specific detailed information on these kits and their individual components. Also available is the interactive Control Zone Kit Pyramid Selection Guide for selection and detailed specification information; found at www.rainbird.com/CZK

Control Zone Selection Chart

Model	Size (Inlet x Outlet)	Flow Range	Inlet Pressure Range	Valve	Filter	Outlet Pressure
COMMERCIAL HIGH FLOW: 15–40 gpm						
XCZ-150-PRB-COM	1½" x 2 @ 1"	15 - 40 gpm	20 - 200 psi	150-PESB	1" Quick Check PR Basket Filter (2)	40 psi
COMMERCIAL MEDIUM FLOW: 3–20 gpm						
XCZ-100-PRB-COM ¹	1" x 1"	3 - 20 gpm	15 - 150 psi	100-PESB	1" Quick Check PR Basket Filter	40 psi
XCZ-100-PRBR ¹	1" x 1"	3 - 20 gpm	15 - 150 psi	100-PESBR	1" PR Basket Filter	40 psi
XCZ-100-PRB-LC ¹	1" x 1"	3 - 20 gpm	15 - 150 psi	100-PGA	1" PR Basket Filter	40 psi
RESIDENTIAL/LIGHT COMMERCIAL MEDIUM FLOW: 3–15 gpm						
XCZF-100-PRF	1" x 1"	3 - 15 gpm	15 - 150 psi	100-DVF	1" PR RBY Filter	40 psi
XCZF-175-PRF	1" x ¾"	3 - 10 gpm	15 - 120 psi	100-DVF	¾" PR RBY Filter	30 psi
XCZ-100-PRF	1" x 1"	3 - 15 gpm	15 - 150 psi	100-DV	1" PR RBY Filter	40 psi
XACZ-100-PRF	1" x 1"	3 - 15 gpm	15 - 150 psi	100-ASVF	1" PR RBY Filter	40 psi
RESIDENTIAL/LIGHT COMMERCIAL LOW FLOW: 0.2–5 gpm						
XCZ-LF-100-PRF	1" x ¾"	0.2 - 5 gpm	15 - 120 psi	LFV-100	¾" PR RBY Filter	30 psi
XCZ-075-PRF	1" x ¾"	0.2 - 5 gpm	15 - 120 psi	LFV-075	¾" PR RBY Filter	30 psi
XACZ-075-PRF	1" x ¾"	0.2 - 5 gpm	15 - 120 psi	ASV-LFV-075	¾" PR RBY Filter	30 psi

* Available with BSP threads

¹ For flows below 5gpm Rain Bird recommends use of upstream filtration to prevent debris from collecting below the diaphragm.

Low Flow Control Zone Kits with PR Filter

Features

- Reliable Control Zone Kits that include the Low Flow Valve, the only valve on the market that can handle low flows (below 3 gpm) without weeping
- Shorter kits with only two components (valve plus pressure-regulating filter) mean that you can fit more Control Zone Kits in a valve box, saving time and money
- These PR Filter kits provide on/off control, filtration, and pressure regulation with fewer components; so there is less chance of leakage at the connections, both at installation and over the life of the system

Operating Range

- Flow: 0.20 to 5.0 gpm (0.8 to 18.9 l/m)
- Inlet pressure: 20 to 150 psi (1.4 to 10.3 bar)
- Regulated pressure: 30 psi (2.1 bar)
- Filtration: 200 mesh stainless steel screen (75 micron)

Models

- XCZ-075-PRF: ¾" Low Flow Valve with ¾" PR RBY Filter (Assembled)
- XCZ-LF-100-PRF: 1" Low Flow Valve with ¾" PR RBY Filter

Replacement Screen

- RBY-200SSMX (200 mesh stainless steel screen)

Minimum Inlet Pressure for 30 psi Outlet Pressure

Flow (gpm)	Inlet Pressure (psi)	
	XCZ-075-PRF	XCZ-LF-100-PRF
0.2	34.4	34.6
1.0	36.1	36.5
3.0	38.1	38.1
5.0	43.4	42.0

Minimum Inlet Pressure for 2.1 bar Outlet Pressure

Flow (l/m)	Inlet Pressure (bar)	
	XCZ-075-PRF	XCZ-LF-100-PRF
0.8	2.4	2.4
3.8	2.5	2.5
11.4	2.6	2.6
18.9	3.0	2.9



Stainless Steel Screen

Four Control Zone Kits in a Standard Valve Box



Stainless Steel Screen

Low Flow Control Zone Kits with Anti-Siphon Valve and PR Filter

Features

- Reliable Control Zone Kits that include the Low Flow Valve, the only valve on the market that can handle low flows (below 3 gpm) without weeping
- Complete, two-piece Control Zone Kits include the field-proven Low Flow Anti-Siphon Valve that has an atmospheric vacuum breaker for backflow prevention and an IAPMO rating
- These PR Filter kits provide on/off control, filtration, and pressure regulation with only two parts; so there is less chance of leakage at the connections, both at installation and over the life of the system

Operating Range

- Flow: 0.20 to 5.0 gpm (0.8 to 18.9 l/m)
- Inlet pressure: 20 to 150 psi (1.4 to 10.3 bar)
- Filtration: 200 mesh stainless steel screen (75 micron)
- Regulated pressure: 30 psi (2.1 bar)

Models

- XACZ-075-PRF: ¾" Low Flow Anti-Siphon Valve with ¾" PR RBY Filter

Replacement Screen

- RBY-200SSMX (200 mesh stainless steel screen)



Stainless Steel Screen

Minimum Inlet Pressure for 30 psi Outlet Pressure

Flow (gpm)	Inlet Pressure (psi) XACZ-075-PRF
0.2	37.4
1.0	39.1
3.0	40.0
5.0	49.7

Minimum Inlet Pressure for 2.1 bar Outlet Pressure

Flow (l/m)	Inlet Pressure (bar) XACZ-075-PRF
0.8	2.6
3.8	2.7
11.4	2.8
18.9	3.4

Medium Flow Control Zone Kits with Anti-Siphon Valve and PR Filter

Features

- Complete, two-piece Control Zone Kits include the field-proven ASVF valve which has an atmospheric vacuum breaker for backflow prevention and an IAPMO rating
- These PR Filter kits provide on/off control, filtration, and pressure regulation with only two parts; so there is less chance of leakage at the connections, both at installation and over the life of the system

Operating Range

- Flow: 3.0 to 15.0 gpm (11.4 to 56.8 l/m)
- Inlet pressure: 20 to 150 psi (1.4 to 10.3 bar)
- Filtration: 200 mesh stainless steel screen (75 micron)
- Regulated pressure: 40 psi (2.8 bar)

Models

- XACZ-100-PRF: 1" ASVF with 1" PR RBY Filter

Replacement Screen

- RBY-200SSMX (200 mesh stainless steel screen)

Stainless Steel Screen



Minimum Inlet Pressure for 40 psi Outlet Pressure

Flow (gpm)	Inlet Pressure (psi) XACZ-100-PRF
3.0	43.3
5.0	44.7
7.0	46.2
9.0	47.3
11.0	50.8
13.0	55.4
15.0	59.7

Minimum Inlet Pressure for 2.8 bar Outlet Pressure

Flow (l/m)	Inlet Pressure (bar) XACZ-100-PRF
11.4	3.0
18.9	3.1
26.5	3.2
34.1	3.3
41.6	3.5
49.2	3.8
56.8	4.1

Medium Flow Control Zone Kits with PR Filter, Flow Control

Features

- Reliable Control Zone Kit that includes a DV valve with flow control for easier system tuning
- These PR Filter kits provide on/off control, filtration, and pressure regulation with only two parts; so there is less chance of leakage at the connections, both at installation and over the life of the system

Operating Range

- Flow: 3.0 to 10.0 gpm (11.4 to 37.9 l/m)
- Inlet pressure: 20 to 120 psi (1.4 to 8.3 bar)
- Filtration: 200 mesh stainless steel screen (75 micron)
- Regulated pressure: 30 psi (2.1 bar)

Models

- XCZF-175-PRF: 1" DVF Valve with 3/4" PR Filter, and MDCF fitting (16-17mm tubing)

Replacement Screen

- RBY-200SSMX (200 mesh stainless steel screen)



Minimum Inlet Pressure for 30 psi Outlet Pressure	
Flow (gpm)	Inlet Pressure (psi) XCZF-175-PRF
3.0	32.7
5.0	36.4
10.0	56.7
15.0	75.5

Minimum Inlet Pressure for 2.1 bar Outlet Pressure	
Flow (l/m)	Inlet Pressure (bar) XCZF-175-PRF
11.4	2.3
18.9	2.5
37.9	3.9
56.8	5.2

Medium Flow Control Zone Kits with PR Filter

Features

- Shorter kits with only two components (valve plus pressure-regulating filter) mean that you can fit more Control Zone Kits in a valve box, saving time and money
- These PR Filter kits provide on/off control, filtration, and pressure regulation with only two parts; so there is less chance of leakage at the connections, both at installation and over the life of the system

Operating Range

- Flow: 3.0 to 15.0 gpm (11.4 to 56.8 l/m)
- Inlet pressure: 20 to 150 psi (1.4 to 10.3 bar)
- Filtration: 200 mesh stainless steel screen (75 micron)
- Regulated pressure: 40 psi (2.8 bar)

Models

- XCZ-100-PRF: 1" DV Valve with 1" PR Filter (Assembled)*
- XCZF-100-PRF: 1" DV Valve with 1" PR Filter, and MDCF fitting (16-17mm tubing)*

* Available with BSP threads

Replacement Screen

- RBY-200SSMX (200 mesh stainless steel screen)



Minimum Inlet Pressure for 40 psi Outlet Pressure		
Flow (gpm)	Inlet Pressure (psi) XCZ-100-PRF	Inlet Pressure (psi) XCZF-100-PRF
3.0	42.9	40.3
5.0	44.1	42.1
10.0	48.5	54.2
15.0	55.5	68.6

Minimum Inlet Pressure for 2.8 bar Outlet Pressure		
Flow (l/m)	Inlet Pressure (bar) XCZ-100-PRF	Inlet Pressure (bar) XCZF-100-PRF
11.4	3.0	2.8
18.9	3.0	2.9
37.9	3.3	3.7
56.8	3.8	4.7

Medium Flow Light Commercial Control Zone Kit with Pressure Regulating, Basket Filter

Features

- Complete kit is the simplest, smallest and most reliable Control Zone Kit for light commercial applications between 5 and 20 gpm (11 and 76 l/m)
- Contains the reliable, flexible and proven PGA valve with the rugged pressure regulating basket filter
- This PR Filter kit provides on/off control, filtration, and pressure regulation with only two parts; so there is less chance of leakage at the connections, both at installation and over the life of the system
- The "No Spill" feature of the basket filter ensures dirt does not fall back into the filter during cleanup operation. The threaded filter top with O-ring makes it easy to remove and clean that stainless steel filter screen

Operating Range

- Flow: 3 to 20 gpm (11,4 to 75.7 l/m)*
- Inlet Pressure: 15 to 150 psi (1,0 to 10,3 bar)
- Regulating Pressure: 40 psi (2,7 bar)
- Filtration: 200 mesh (75 micron) stainless steel
- Temperature: Up to 150 degree F (66 degree C)

Model

- XCZ-100-PRB-LC: 1" PGA Valve with 1" Pressure Regulating (40 psi), Basket Filter

Replacement Filter Screens

- QKCHK-100M: 100 mesh stainless steel screen, red
- QKCHK-200M: 200 mesh stainless steel screen, white

Replacement Cap

- BFCAP (Complete cap with body o-ring)

** For flows below 5gpm Rain Bird recommends use of upstream filtration to prevent debris from collecting below the diaphragm*

Minimum Inlet Pressure for 40 psi Outlet Pressure

Flow (gpm)	Inlet Pressure (psi) XCZ-100-PRB-LC
5.0	43.0
10.0	48.0
15.0	56.0
20.0	65.0

Minimum Inlet Pressure for 2.8 bar Outlet Pressure

Flow (l/m)	Inlet Pressure (bar) XCZ-100-PRB-LC
18.9	2.9
37.9	3.3
56.8	3.8
75.7	4.5



Stainless
Steel
Screen

XCZ-100-PRB-LC

Medium Flow Commercial Control Zone Kit with Pressure Regulating, Basket Filter

Features

- Complete kit is the simplest, smallest and most reliable Control Zone Kit for commercial applications between 3 and 20 gpm (11 and 76 l/m)
- Contains the reliable, proven PESB Valve which provides patented scrubbing action, making this kit ideal for commercial dirty water applications
- Includes the Pressure Regulating, Quick-Check Basket Filter that has a clear indicator which goes from green to red, telling you when to clean the filter. This reduces maintenance and takes the guesswork out of cleaning the filter. In addition, the threaded top makes it easy to remove and clean the stainless steel screen
- Basket Filter and Pressure Regulator have been combined for one smaller Pressure Regulating, Quick-Check Basket filter that is 24% smaller than the previous unit

Operating Range

- Flow: 3.0 to 20.0 gpm (11.4 to 75.7 l/m)*
- Inlet Pressure: 15 to 150 psi (1,0 to 10,3 bar)
- Regulating Pressure: 40 psi (2,7 bar)
- Filtration: 200 mesh (75 micron) stainless steel
- Temperature: Up to 150° F (66° C)

Model

- XCZ-PRB-100-COM: 1" Ball Valve with 1" PESB Valve and 1" Pressure Regulating (40 psi), Quick-Check Basket Filter
- XCZ-100-PRBR: 1" PESBR Valve and 1" Pressure Regulating (40psi) Basket Filter

Replacement Screen

- QKCHK100M (100 mesh stainless steel screen)
- QKCHK200M (200 mesh stainless steel screen)

Replacement Cap

- QKCHKCAP (Complete cap with body o-ring)

* For flows below 5gpm Rain Bird recommends use of upstream filtration to prevent debris from collecting below the diaphragm

Minimum Inlet Pressure for 40 psi Outlet Pressure

Flow (gpm)	Inlet Pressure (psi) XCZ-PRB-100-COM	Inlet Pressure (psi) XCZ-100-PRBR
3	42.0	—
5	44.0	45.0
10	47.3	49.0
15	53.0	57.0
20	62.5	—

Minimum Inlet Pressure for 2.8 bar Outlet Pressure

Flow (l/m)	Inlet Pressure (bar) XCZ-PRB-100-COM	Inlet Pressure (bar) XCZ-100-PRBR
11.4	2.9	—
18.9	3.0	3.1
37.9	3.3	3.4
56.8	3.6	3.9
75.7	4.3	—



XCZ-100-PRBR



XCZ-PRB-100-COM

Stainless
Steel
Screen

High Flow Commercial Control Zone Kit with 2 Pressure Regulating, Basket Filters

Features

- Highest flow Control Zone Kit on the market for large, commercial drip zones 15.0 to 40.0 gpm (56,8 to 151,4 l/m)
- Contains the reliable, proven 1 ½" PESB Valve which provides patented scrubbing action, making this kit ideal for commercial dirty water applications
- Includes 2 Pressure Regulating, Quick-Check Basket Filter that have a clear indicator which goes from green to red, telling you when to clean the filter. This reduces maintenance and takes the guesswork out of cleaning the filter. In addition, the threaded top makes it easy to remove and clean the stainless steel screen
- Basket Filter and Pressure Regulator have been combined for one smaller Pressure Regulating, Quick-Check Basket filter that is 22% smaller than the previous unit

Operating Range

- Flow: 15.0 to 40.0 gpm (56,8 to 151,4 l/m)
- Inlet Pressure: 20 to 150 psi (1,4 to 10,3 bar)
- Regulating Pressure: 40 psi (2,7 bar)
- Filtration: 200 mesh (75 micron) stainless steel
- Temperature: Up to 150° F (66° C)

Models

- XCZ-PRB-150-COM: 1 1/2" PESB Valve with two 1" Pressure Regulating (40 psi), Quick-Check Basket Filters

Replacement Screen

- QKCHK100M (100 mesh stainless steel screen)
- QKCHK200M (200 mesh stainless steel screen)

Replacement Cap

- QKCHKCAP (Complete cap with body o-ring)

Minimum Inlet Pressure for 40 psi Outlet Pressure	
Flow (gpm)	Inlet Pressure (psi) XCZ-PRB-150-COM
15.0	40.0
20.0	49.0
25.0	50.2
30.0	53.5
35.0	56.1
40.0	60.7

Minimum Inlet Pressure for 2.8 bar Outlet Pressure	
Flow (l/m)	Inlet Pressure (bar) XCZ-PRB-150-COM
56.8	2.8
75.7	3.4
94.7	3.5
113.6	3.7
132.5	3.9
151.4	4.2



XCZ-PRB-150-COM

Low Flow Valves

Valves designed exclusively for the low flow rates of a drip irrigation system (0.2 - 8.0 gpm; 0.6 to 30 l/m)

Features

- The only valves in the industry made specifically for drip irrigation systems, making these the only valves that can effectively handle particles at low flow rates – patented design
- These valves contain all of the features of reliable Rain Bird DV or ASVF valves, coupled with a unique diaphragm design that allows particles to pass through at extremely low flow rates, thereby preventing weeping of the valve
- Allows the filter to be safely placed downstream of the valve since these valves handle all sizes of particles
- Unique “double-knife” diaphragm coupled with 1/2" diameter seat for flawless operation at low flow rates
- Low Flow Valve is available in 3/4" In-line model, and 3/4" Anti-Siphon Valve
- Double-filtered pilot flow design for maximum reliability
- External bleed to manually flush the system of dirt and debris during installation and system start-up
- Internal bleed for spray-free manual operation.

Operating Range

- Flow: 0.20 to 8.0 gpm (0.6 to 30.0 l/m)
- Pressure: 15 to 150 psi (1.0 to 10.3 bar)

Electrical Specifications

- 24 VAC 50/60 Hz (cycles/sec) solenoid
- Inrush current: 0.30 (7.2 VA) at 60 Hz
- Holding current: 0.19 A (4.56 VA)

Models

- Lfv-075: 3/4" Low Flow DV Valve
- Lfv-100*: 1" Low Flow DV Valve
- ASV-LF-075: 3/4" Low Flow Anti-Siphon Valve

**Available with BSP threads*

Replacement Diaphragm

- LFVDIAPHRM: Low Flow Valve Diaphragm Spare Part



LFV-075



ASV-LF-075

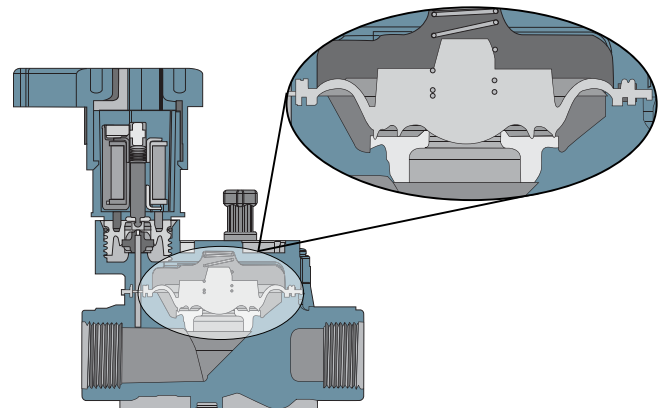

Unique Diaphragm Design

Pressure Loss Characteristics

Flow gpm	LFV-075 psi	LFV-100 psi	ASV-LF-075 psi
0.2	3.0	3.0	2.5
1.0	3.2	3.2	3.1
2.0	3.3	3.3	3.7
4.0	3.6	3.6	4.6
6.0	4.2	4.2	5.3
8.0	5.1	5.1	5.7

Pressure Loss Characteristics

METRIC

Flow l/m	LFV-075 bar	LFV-100 bar	ASV-LF-075 bar
0.6	0.21	0.21	0.17
3.6	0.22	0.22	0.22
7.8	0.23	0.23	0.27
15.0	0.25	0.25	0.31
22.8	0.28	0.28	0.35
30.0	0.35	0.35	0.39

Inline RBY Filter

Static filter helps prevent plugging in a drip irrigation system

Features

- A simple and reliable filter for low-volume irrigation systems
- Simple to clean, as cap has a sealing O-ring and unthreads to provide access to the stainless steel filter element
- Strong and reliable due to its robust design and glass-filled polypropylene construction
- Male x Male threaded connections for direct connection to valves and pressure regulators
- Replacement stainless steel elements are available in 200 mesh (75 micron)

Operating Range

- Flow:
 - ¾" units: 0.20 to 12.0 gpm (0.8 to 45.4 l/m)
 - 1" units: 0.20 to 18.0 gpm (0.8 to 68.1 l/m)
- Pressure: 20 to 150 psi (1.4 to 10.3 bar)
- Filtration: 200 mesh (75 micron)

Models

- RBY075MPTX: ¾" Inline RBY Filter with 200 Mesh Screen
- RBY100MPTX: 1" Inline RBY Filter with 200 Mesh Screen*

Replacement screen:

- RBY-200SSMX (200 mesh stainless steel screen)



RBY075MPTX

Pressure Loss Characteristics

Flow Rate		RBY075MPTX		RBY100MPTX	
gpm	l/m	psi	bar	psi	bar
1.00	0.8	0.1	0.00	0.1	0.00
3.00	3.8	0.4	0.01	0.3	0.01
5.0	11.4	1.1	0.03	0.5	0.02
7.0	18.9	1.6	0.08	0.8	0.03
9.0	26.5	2.7	0.11	1.4	0.06
12.0	34.1	4.5	0.19	2.2	0.10
14.0	45.4	--	0.31	3.0	0.15
16.0	53.0	--	--	3.8	0.21
18.0	60.6	--	--	4.7	0.26
	68.1	--	--	--	0.32

Note: Pressure loss for 200 mesh filter screen

Pressure-Regulating Filter (RBY)

Unique, compact unit that works with all valves to create a simple, efficient control zone. Combines filtration and pressure regulation in one piece for protection of downstream components in a low-volume irrigation system

Features

- Reduces the number of components in a control zone, making it smaller and easier to install. More control zones can fit in one valve box!
- Combination unit comes with 200 mesh (75 micron) stainless steel reduces the number of connections, making installation easier and faster
- Static RBY filter regulates pressure to a nominal 30 or 40 psi (2.0 or 2.8 bar) -PR RBY Filter Cap has sealing O-ring and unthreads to provide access to the filter element for easy cleaning
- 30 or 40 psi pressure regulator is integrated into the filter body
- Robust body and cap are made of glass-filled polypropylene and provide 150 psi (10.3 bar) pressure rating

Operating Range

- Flow - ¾" units: 0.20 to 5.0 gpm (0.8 to 18.9 l/m)
 - 1" units: 3.0 to 15.0 gpm (11.4 to 56.8 l/m)
- Inlet pressure: 20 to 150 psi (1.4 to 10.3 bar)
- Regulated pressure: - ¾" units: 30 psi (2.1 bar)
 - 1" units: 40 psi (2.8 bar)

Components of Control Zone Kits Found on pg. 141-146

Models

- PRF-075-RBY: ¾" PR RBY Filter
- PRF-100-RBY: 1" PR RBY Filter

Replacement Screen

- RBY-200SSMX (200 mesh stainless steel screen)

Stainless Steel Screen



PRF-075-RBY and PRF-100-RBY

Pressure Loss Characteristics

Flow		PRF-075-RBY		PRF-100-RBY	
gpm	l/m	psi	bar	psi	bar
0.2	0.8	3.0	0.21	N/A	N/A
1.0	3.8	4.0	0.28	N/A	N/A
3.0	11.4	6.1	0.42	0.8	0.06
5.0	18.9	10.0	0.69	2.0	0.14
8.0	30.3	N/A	N/A	3.8	0.26
10.0	37.9	N/A	N/A	5.2	0.36
15.0	56.8	N/A	N/A	12.0	0.83

Note: Pressure loss for 200 mesh filter screen

Quick-Check Basket Filter

The only commercial-grade filter with a clean/dirty indicator for low-volume irrigation zones

Features

- Reduces maintenance and labor costs — the indicator tells you when to clean the filter, taking the guesswork out of cleaning the filter
- Provides increased reliability – “No-spill” feature ensures dirt does not fall back into the filter during cleanup operation
- Simplifies installation and maintenance - threaded top with O-ring makes it easy to remove and clean the screen
- Available in ¾" and 1" models
- Comes pre-assembled with 200 mesh (75 micron) stainless steel screen (other screen sizes available)
- Also available in Commercial Control Zone Kits (XCZ-PRB-100-COM and XCZ-PRB-150-COM)

Operating Range

- Flow
 - ¾" Basket Filter: 0.20 to 12.0 gpm (0.8 to 45.4 l/m)
 - 1" Basket Filter: 3.0 to 20.0 gpm (11.4 to 75.7 l/m)
- Pressure: 0-150 psi (0 to 10.3 bar)

Models

- QKCHK-075: ¾" Basket Filter with 200 mesh screen
 - QKCHK-100*: 1" Basket Filter with 200 mesh stainless steel screen
- * Available with BSP threads*

Replacement Filter Screens

- QKCHK-100M: 100 mesh screen, red
- QKCHK-200M: 200 mesh stainless steel screen, white

Replacement Cap

- QKCHKAP (Complete cap with body o-ring)

Pressure Loss Characteristics - QKCHK-075

Flow Rate		200 mesh screen	
gpm	l/m	psi	bar
0.20	0.8	0.0	0.00
2.00	7.6	0.0	0.00
4.00	15.1	0.1	0.01
6.0	22.7	0.4	0.03
8.0	30.3	0.9	0.06
10.0	37.9	1.3	0.09
12.0	45.4	2.0	0.14

Pressure Loss Characteristics - QKCHK-100

Flow Rate		200 mesh screen	
gpm	l/m	psi	bar
3.0	11.4	0.0	0.01
5.0	18.9	0.0	0.01
7.0	26.5	0.4	0.03
9.0	34.1	0.7	0.05
11.0	41.6	1.1	0.08
14.0	53.0	1.6	0.11
17.0	64.4	2.3	0.16
20.0	75.7	3.2	0.22

Note: Pressure loss for 200 mesh filter screen

Stainless
Steel
Screen



QKCHK-075

Pressure Regulating, and Quick-Check Pressure Regulating Basket Filters

The only commercial-grade filter with built in pressure regulator for low-volume irrigation zones. Also available with a clean/dirty indicator.

Features

- Reduces maintenance and labor costs - 40% larger filter surface than standard filters means less frequent cleaning
- Provides increased reliability – “No Spill” feature ensures dirt does not fall back into the filter during cleanup operation
- Simplifies installation and maintenance – threaded top with O-ring makes it easy to remove and clean that stainless steel filter screen
- Efficient design – combines filtration and pressure regulation in one compact unit with fewer connections
- Available in 1" model
- Comes pre-assembled with 200 mesh (75 micron) stainless steel screen (other screen sizes available)
- Built-in 40 psi (2,7 bar) pressure regulator
- Also available in Light Commercial Control Zone Kits:
 - XCZ-100-PRB-LC (without Quick-Check feature)
 - XCZ-PRB-100-COM (with Quick-Check)
 - XCZ-PRB-150-COM (with Quick-Check)

Operating Range

- Flow: 5.0 to 20 gpm (18.9 to 75.7 l/m)
- Inlet Pressure: 15 to 150 psi (1,0 to 10,3 bar)
- Regulating Pressure: 40 psi (2,7 bar)
- Filtration: 200 mesh (75 micron) stainless steel
- Temperature: Up to 150 degree F (66 degree C)

Components
of Control Zone
Kits Found on
pg. 141-146

Models

- PRB-100: 1" Basket Filter with built-in Pressure Regulator (40 psi) and 200 mesh (75 micron) stainless steel screen
- PRB-QKCHK-100: 1" Basket Filter with built-in Pressure Regulator (40 psi) and 200 mesh (75 micron) stainless steel screen

Replacement Filter Screens

- QKCHK-100M: 100 mesh stainless steel screen, red
- QKCHK-200M: 200 mesh stainless steel screen, white

Replacement Cap

- QKCHKCAP (Complete cap with body o-ring)

Minimum Inlet Pressure for 40 psi Outlet Pressure

Flow (gpm)	Inlet Pressure (psi) PRB-100 / PRB-QKCHK-100
3.0	40.0
5.0	40.0
10.0	42.6
15.0	48.2
20.0	60.0

Minimum Inlet Pressure for 2.8 bar Outlet Pressure

Flow (l/m)	Inlet Pressure (bar) PRB-100 / PRB-QKCHK-100
11.4	2.8
18.9	2.8
37.9	2.9
56.8	3.3
75.7	4.1

Stainless
Steel
Screen



PRB-100



PRB-QKCHK-100

Large-Capacity Filters

Large-Capacity high flow and low maintenance with a solid build

Features

- Provides extra large filtration capacity for residential, commercial, and municipal applications
- Durable filters can be easily removed for cleaning, significantly reducing cleaning time
- Disc filters can decompress for easy cleaning
- Auxiliary connection with a threaded cap can be drilled to allow draining or depressurization

Operating Range

- 1" Model: Maximum flow: Up to 26 gpm (6 m³/hr)
 - Filtering surface (disc): 28 in₂ (180 cm₂)
- 1.5" Models: Maximum flow: Up to 88 gpm (20 m³/hr)
 - Filtering surface (disc): 83 in₂ (535 cm₂)
 - Filtering surface (screen): 76 in₂ (490 cm₂)
- 2" Models: Maximum flow: Up to 110 gpm (25 m³/hr)
 - Filtering surface (disc): 81 in₂ (525 cm₂)
 - Filtering surface (screen): 75 in₂ (485 cm₂)
- Maximum Pressure: 116 psi (8 bar)
- Maximum Temperature: Up to 140° F (60° C)

Models

- LCRBY100D - 1" Large-Capacity Disc Filter
- LCRBY150S - 1.5" Large-Capacity Screen Filter
- LCRBY150D - 1.5" Large-Capacity Disc Filter
- LCRBY200S - 2" Large-Capacity Screen Filter
- LCRBY200D - 2" Large-Capacity Disc Filter

Spare Parts

- SMFC120MS - ¾" - 1" SCRNCART LG CAP 120M
- SMFC120MD - ¾" - 1" DISC CART LG CAP 120M
- LGFC120MS - 1½" - 2" SCRNCRT LG CAP 120M
- LGFC120MD - 1½" - 2" DISC CRT LG CAP 120M

Specifications

- Inlet / Outlet Size:
 - 1" Models: 1" NPT
 - 1.5" Models: 1.5" NPT
 - 2" Models: 2" NPT

Filtration

- Stainless Steel Screen Filter: 120 Mesh (130 Micron)*
- Plastic Filter Discs: 120 Mesh (130 Micron)

* Screen not available in 1" model

NEW



LCRBY200D



Disc & Screen Filters

Pressure Loss Characteristics - DISC FILTER

Flow Rate		1" Filter		1.5" Filter		2" Filter	
gpm	l/m	psi	bar	psi	bar	psi	bar
5	18.93	0.60	0.04	0.08	0.01	0.10	0.01
11	41.67	1.16	0.08	0.18	0.01	0.10	0.01
22	83.33	2.61	0.18	0.40	0.03	0.10	0.01
33	125.0	4.35	0.30	0.73	0.05	0.24	0.02
44	166.67	—	—	1.05	0.07	0.40	0.03
55	208.33	—	—	1.50	0.10	0.60	0.04
66	250.00	—	—	2.18	0.15	0.82	0.06
77	291.67	—	—	3.10	0.21	1.10	0.08
88	333.33	—	—	3.95	0.27	1.60	0.11
99	375.00	—	—	—	—	2.03	0.14
110	416.67	—	—	—	—	2.47	0.17

Pressure Loss Characteristics - SCREEN FILTER

Flow Rate		1" Filter		1.5" Filter		2" Filter	
gpm	l/m	psi	bar	psi	bar	psi	bar
5	18.93	0.80	0.06	0.00	0.00	0.00	0.00
11	41.67	1.74	0.12	0.00	0.00	0.00	0.00
22	83.33	2.90	0.20	0.50	0.03	0.20	0.01
33	125.0	4.06	0.28	0.95	0.07	0.25	0.02
44	166.67	—	—	1.45	0.10	0.44	0.03
55	208.33	—	—	1.89	0.13	0.60	0.04
66	250.00	—	—	2.32	0.16	0.87	0.06
77	291.67	—	—	2.76	0.19	1.16	0.08
88	333.33	—	—	3.19	0.22	1.45	0.10
99	375.00	—	—	—	—	1.89	0.13
110	416.67	—	—	—	—	2.32	0.16

Note: Body dimensions are available on the Rain Bird website

Inline Pressure Regulators

Features

- Can be installed above or below grade
- Preset outlet pressure: 30 psi (2.0 bar) and 40 psi (2.8 bar)
- ¾" or 1" NPT female-threaded inlet and outlet

Operating Range

- Flow
 - PSI-L30X-075: 0.10 to 5.0 gpm; 6 to 300 gph (0.4 to 18.9 l/m)
 - PSI-M30X-075, psi-M40X-075: 2.0 to 10.0 gpm; 120 to 600 gph (7.8 to 37.9 l/m)
 - PSI-M40X-100: 2.0 to 20.0 gpm; 120 to 900 gph (7.8 to 56.8 l/m)
- Inlet Pressure: 10-150 psi (0.7 to 10.3 bar)

Models

- PSI-L30X-075: ¾" 30 psi (2.1 bar) regulator for low flow (red label)
- PSI-M30X-075: ¾" 30 psi (2.1 bar) regulator for medium flow (yellow label)
- PSI-M40X-075: ¾" 40 psi (2.8 bar) regulator for medium flow (yellow label)
- PSI-M40X-100: 1" 40 psi (2.8 bar) regulator for medium flow

Retrofit Pressure Regulators

Features

- Provides convenient 30 psi (2.1 bar) pressure regulation at the riser for any ½" FPT emission device or compression adapter
- Can be installed above or below grade
- Can be used with Xeri-bird™ 8 Multi-Outlet Emission Device (see page 113)

Operating Range

- Flow: 0.50 to 4.00 gpm; 30 to 240 gph (1.9 to 15.1 l/m)
- Inlet Pressure: 15 to 70 psi (1.0 to 4.8 bar)

Dimensions

- ½" female-threaded inlet
- Height: 4" (10 cm)

Model

- PRS-050-30



PSI-L30X-075, PSI-M40X-075, PSI-M40X-100



PRS-050-30



Water Saving Tips

- Newer high-efficiency motors are able to convert a higher percentage of their electric input to useful mechanical work resulting in energy and cost savings.
- Rain Bird Variable Frequency Drive (VFD) pump stations save energy while delivering the water pressure necessary to ensure maximum water use efficiency.
- Rain Bird designs pump stations specifically for the application, ensuring that the pump runs at maximum efficiency. Delivering the right pressure as demanded by the system ensures your irrigation system is efficient and effective. For assistance call 520-806-5620 or email pumps@rainbird.com.

Introduction

Spray Bodies

Spray Nozzles

Rotors

Valves

Controllers

Central Controls

Landscape Drip

Pumps

Drainage Products

Resources

Rain Bird® LC Series

¾ to 3 hp; Up to 60 psi (4.1 bar); Up to 115 gpm (26.1 m³/h)

Features

- Revolutionary complete pump package that includes a professional-grade pump, the highest quality pump protection and simple to install and operate fixtures all housed in a unique enclosure designed specifically for a pump
- Heavy duty pump available in ¾, 1, 1½, 2, and 3 hp offers brass impellers, cast iron housing & stainless steel bolts & ports for pressure, temperature probe & priming
- PSRPT for Shut-down protection. Provides protection if pump experiences loss of pressure or high temperature situations. The PSRPT is housed in a powder coated steel enclosure
- Aesthetically pleasing powder coated enclosure. Provides safe and vandal proof encasement of pump and controls
- Clam shell powder coated steel enclosure. Offers full accessibility to pump and electrical controls
- Quick disconnecting coupling on discharge and suction provides simple on-off connections to speed the hook-up and winterization processes
- Cooling louvres provide ample air to prevent motor and pump from overheating
- 1.5" PVC adapter and pan drain, discharge line through bottom of enclosure insures against theft
- Discharge option through bottom of enclosure or side of enclosure
- Quick disconnecting piggy-tail power cord assures at-pump safety
- 230 volt main power plug
- Padlock ring for security

Electrical Power Specification

- 60Hz, 1-phase power: 208V, 230V

Applications

- Suction Lift or Boost
- Potable or Reclaimed Water Supply
- Residential, Light Commercial, Parks, or Recreational

Capacity US gpm based on 5ft. Suction Lift									
HP	Discharge psi								
	20	25	30	35	40	45	50	55	60
1	73	65	57	47	35	18	-	-	-
1.5	75	70	68	60	48	35	-	-	-
2	102	98	92	82	74	61	52	40	-
3	115	114	112	105	100	88	72	56	30



LC Series

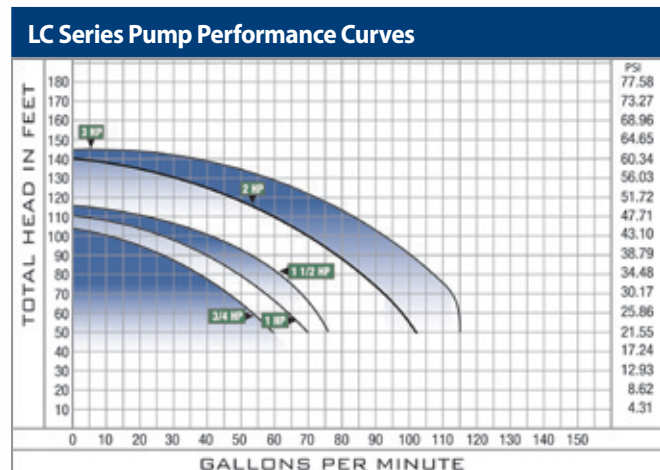

Low Profile Pump Stations – LP Series

Rain Bird's LP Series Horizontal End Suction and Vertical multistage pump stations are designed for small to midsize boost, flooded suction and suction lift applications such as city parks and buildings, sports fields, commercial buildings, small home owner's associations and large residential sites. Its low profile design, durable centrifugal or vertical multistage pump configuration, and choice of options make it an ideal choice for Turf irrigation applications.

Standard Features

- Cost effective – Standardized VFD driven pump system in enclosure delivers high performance with minimum investment
- Low Profile – Compact aluminum enclosure with powder coated skid and piping
- Energy efficient – Variable Frequency Drive (VFD) maintains constant pressure at varying flow demand
- Reliability – Simple, standard design, easy installation and maintenance
- Mechanical Features
 - Inlet Butterfly Isolation Valve
 - Discharge Butterfly Isolation Valve
 - Silent Check Valve
- Enclosures / External Connections
 - Marine Grade Aluminum Enclosure
 - Polyester Powder-Coated Steel Deck and Piping
 - Thermostat and Fan on Mechanical Enclosure
- Pump Control
 - Pump Start Relay
 - VFD - Variable Frequency Drive for Control of Pressure
- Display
 - Monochrome Touch Screen Display

Optional Features and Accessories

Visit: www.rainbird.com/landscape/products/pumps

Models

- **Horizontal End Suction - LP Series**
 - 5 to 10 HP; Up to 100 psi (6.9 bar); Up to 200 gpm (12.6 lps, 45.4 m³/h)
- **Vertical Multistage - LP Series**
 - 1 to 2 HP; Up to 50 psi (3.5 bar); Up to 60 gpm (3.8 lps, 13.6 m³/h)

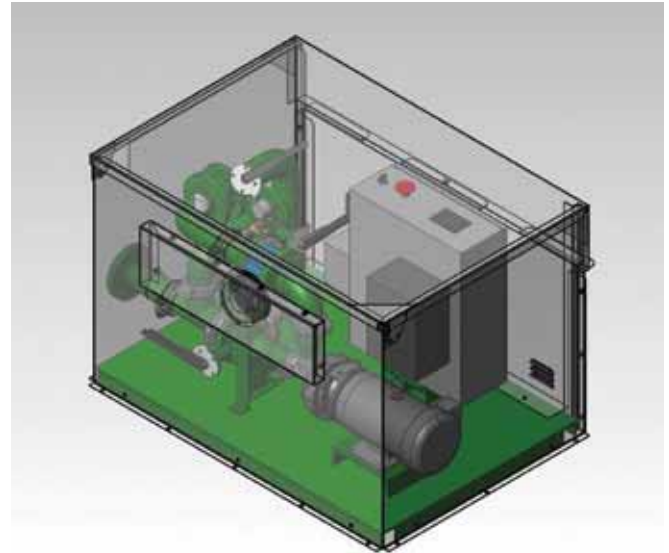

Horizontal End Suction - LP Series Shown
 5 to 10 HP; Up to 100 psi (6.9 bar);
 Up to 200 gpm (12.6 lps, 45.4 m³/h)

LP Series – Horizontal End Suction - 1 Pump – Aluminum Enclosure			
Motor Size	5 HP	7.5 HP	10 HP
Pump Type	Horizontal End Suction		
Power Requirement	480/60/3 V/HZ/PH		
	208-230/60/3 V/HZ/PH		
	208-230/60/1 V/HZ/PH		
Inlet Pressure Requirement	Suction Lift or Boost Applications		
Outlet Pressure	Up to 100 psi (6.9 bar) ⁽¹⁾		
Outlet Flow	Up to 200 gpm (12.6 lps, 45.4 m ³ /h) ⁽¹⁾		
Concrete Slab Dimensions (min)	65" x 49" (165 cm x 125 cm)		
Platform Skid Dimensions (min)	53" x 39.75" (135 cm x 101 cm)		
Inlet / Discharge Size	2" Flange Fitting (adapter)	3" Flange Fitting	4" Flange Fitting (adapter)
Cabinet Height (from slab)	35" (89 cm)		

LP Series – Vertical Multistage – 1 Pump – Aluminum Enclosure			
Motor Size	1 HP	1.5 HP	2 HP
Pump Type	Vertical Multistage		
Power Requirement	480/60/3 V/HZ/PH		
	208-230/60/3 V/HZ/PH		
	208-230/60/1 V/HZ/PH		
Inlet Pressure Requirement	Suction Lift or Boost Applications		
Outlet Pressure	Up to 50 psi (3.5 bar) ⁽¹⁾		
Outlet Flow	Up to 60 gpm (3.8 lps, 13.6 m ³ /h) ⁽¹⁾		
Concrete Slab Dimensions (min)	65" x 49" (165 cm x 125 cm)		
Platform Skid Dimensions (min)	53" x 39 3/4" (135 cm x 101 cm)		
Inlet / Discharge Size	2" flange fitting standard - 3" and 4" adapters available		
Cabinet Height (from slab)	35" (89 cm)		

(1) Refer to pump performance curves, provided upon request from pumps@rainbird.com

Low to Medium Flow Pump Stations – D-Series

Rain Bird's single pump, Vertical Multi-Stage and Horizontal End Suction stations in powder-coated green enclosures are designed for small to midsize boost, flooded suction and suction lift applications such as city parks and buildings, sports fields, commercial buildings, small home owner's associations and large residential sites. Its small footprint, durable centrifugal or multistage pump configuration, and choice of options make it an ideal choice for Turf irrigation applications.

Standard Features

- Reliability – Integrated Plug-n-Pump provide single source responsibility for the entire pumping system insuring trouble-free installation and operation
- Energy efficient – Variable Frequency Drive (VFD) maintains constant pressure at varying flow demand
- Inlet and discharge isolation valves for easier mechanical serviceability
- Easy Start-up – All stations are water-tested at the factory prior to shipment.
- Mechanical Features
 - Inlet Butterfly Isolation Valve
 - Discharge Butterfly Isolation Valve
 - Silent Check Valve
- Pressure / Flow
 - Stainless Steel Pressure Transducer
 - Flow Switch
- Enclosures / External Connections
 - Polyester Powder Coated Steel Enclosure
 - Polyester Powder-Coated Steel Deck and Piping
 - Re-Prime Piping (Suction Lift only)
 - Thermostat and Fan on Mechanical Enclosure
- Pump Control
 - Pump Start Relay
 - VFD - Variable Frequency Drive for Control of Pressure
- Display
 - Monochrome Touch Screen Display

Optional Features and Accessories

Visit: www.rainbird.com/landscape/products/pumps

Models

- **Vertical Multistage – 1 Pump – D Series**
 - 3 to 15 HP; Up to 115 psi (7.9 bar); Up to 200 gpm (12.6 lps, 45.4 m³/h)
- **Horizontal End Suction - 1 Pump - D Series**
 - 5 to 20 HP; Up to 130 psi (9.0 bar); Up to 350 gpm (22.1 lps, 79.5 m³/h)

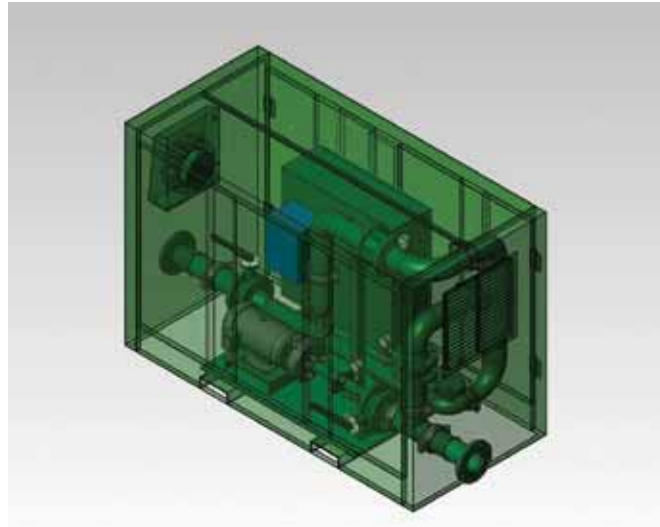

Horizontal End Suction - 1 Pump - D Series shown
5 to 20 HP; Up to 130 psi (9.0 bar);
Up to 350 gpm (22.1 lps, 79.5 m³/h)

D-Series – Vertical Multistage – 1 Pump – Green Enclosure					
Motor Size	3 HP	5 HP	7 ½ HP	10 HP	15 HP
Pump Type	Vertical Multi-Stage				
Power Requirement	480/60/3 V/Hz/PH				
	208-230/60/3 V/Hz/PH				
	208-230/60/1 V/Hz/PH				
Inlet Pressure Requirement	Suction Lift or Boost Applications				
Outlet Pressure	Up to 115 psi (7.9 bar) ⁽¹⁾				
Outlet Flow	Up to 200 gpm (12.6 lps, 45.4 m ³ /h) ⁽¹⁾				
Concrete Slab Dimensions (min)	90" x 48" (229 cm x 122 cm)				
Platform Skid Dimensions (min)	78" x 36" (198 cm x 91 cm)				
Inlet / Discharge Size	4" Standard - 2", 3", and 6" adapters available				
Cabinet Height (from slab)	52" (132 cm)				

D-Series – Horizontal End Suction – 1 Pump – Green Enclosure					
Motor Size	5 HP	7 ½ HP	10 HP	15 HP	20 HP
Pump Type	Horizontal End Suction				
Power Requirement	480/60/3 V/Hz/PH				
	208-230/60/3 V/Hz/PH				
	230/60/1 V/Hz/PH		208/60/1 V/Hz/PH		
Inlet Pressure Requirement	Suction Lift (up to 3 ft. lift), or Boost Applications				
Outlet Pressure	Up to 130 psi (9.0 bar) ⁽¹⁾				
Outlet Flow	Up to 350 gpm (22.1 lps, 79.5 m ³ /h) ⁽¹⁾				
Concrete Slab Dimensions (min)	90" x 48" (229 cm x 122 cm)				
Platform Skid Dimensions (min)	78" x 36" (198 cm x 91 cm)				
Inlet / Discharge Size	4" standard - 2", 3" and 6" adapters are external accessories				
Cabinet Height (from slab)	52" (132 cm)				

⁽¹⁾ Refer to pump performance curves, provided upon request from pumps@rainbird.com

Medium Flow Pump Station

Rain Bird's single pump, Vertical Multi-Stage Enhanced station in a compact enclosure is designed for medium-flow boost, flooded suction and suction lift applications, such as; parks, sports complexes, golf courses, turf farms and other agricultural projects. Its compact design, durable centrifugal pump configuration, choice of options and enclosures make it an ideal choice for Turf irrigation applications with flows up to 500 gpm (31.5 lps, 114 m³/h).

Standard Features

- Entry Level through High Performance
- Control Package – With either a cost-effective monochrome touch-panel display or high resolution color touch-panel display for improved user interfaced and remote monitoring via VNC (Virtual Network Computing)
- Energy efficient – Variable Frequency Drive (VFD) maintains constant pressure at varying flow demand
- Enhanced Serviceability – Modern electrical design utilizing industrial breaker motor protection instead of fuses. Industrial circuit breakers are quickly reset and designed for an extended service life
- Inlet and discharge isolation valves for easier mechanical serviceability
- Plumbing Configurations
 - Inlet and Discharge Piping on same side of the enclosure (as shown)
- Mechanical Features
 - Inlet Butterfly Isolation Valve
 - Discharge Butterfly Isolation Valve
 - Pump Isolation Valve
 - Silent Check Valve
- Pressure / Flow
 - Stainless Steel Pressure Transducer
 - Flow Switch
- Enclosures / External Connections
 - Marine Grade Aluminum Enclosure
 - Polyester Powder-Coated Steel Deck and Piping
 - Thermostat and Fan on Mechanical Enclosure

Optional Features

Visit: www.rainbird.com/landscape/products/pumps

Models

- **Vertical Multi-Stage – 1 Pump Enhanced – Aluminum Enclosure**
 - 5 to 50 HP; Up to 150 psi (10.3 bar); Up to 500 gpm (31.5 lps, 114 m³/h)

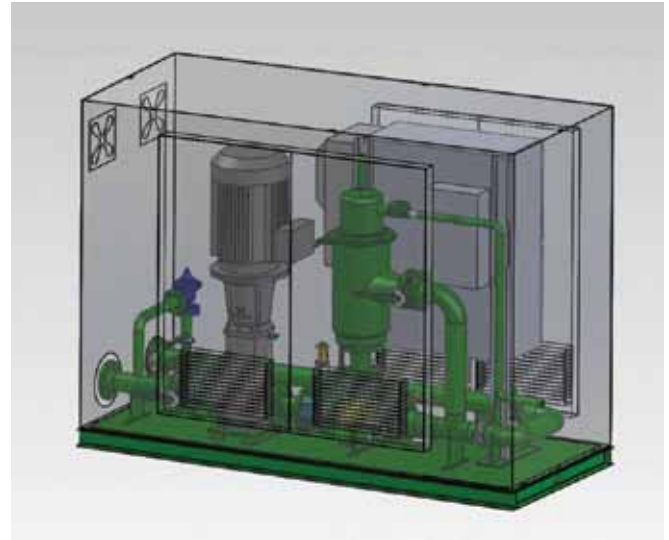

Vertical Multi-Stage – 1 Pump Enhanced – Aluminum Enclosure shown
5 to 50 HP; Up to 150 psi (10.3 bar);
Up to 500 gpm (31.5 lps, 114 m³/h)

Vertical Multi-Stage – 1 Pump Enhanced – Aluminum Enclosure										
Motor Size	5 HP	7.5 HP	10 HP	15 HP	20 HP	20 HP	25 HP	30 HP	40 HP	50 HP
Pump Type	Vertical Multi-Stage									
Power Requirement (Other power configurations available upon request)	208-230/1/60 V/PH/HZ									
	208-230/3/60 V/PH/HZ									
	480/3/60 V/PH/HZ									
	575/3/60 V/PH/HZ									
Inlet Pressure Requirement	Suction Lift or Boost Applications									
Outlet Pressure	Up to 150 psi (10.3 bar) ⁽¹⁾									
Outlet Flow	Up to 500 gpm (31.5 lps, 114 m ³ /h) ⁽¹⁾									
Concrete Slab Dimensions (min)	10' 3" x 4' 9" (312.4 cm x 145 cm)									
Platform Skid Dimensions (min)	9' 3" x 3' 9" (281 cm x 114.3 cm)									
Inlet / Discharge Size	4" Flanges Standard, 6" Inlet Flange (Suction Lift), 3", 4", 6", 8" Adapters Available									

⁽¹⁾ Refer to pump performance curves, provided upon request from pumps@rainbird.com

Main Irrigation Pump Stations

Flows Up to 2400 GPM at 110 psi.

Reliable Variable Frequency Drive Pump Stations designed to serve as the main irrigation pump station for golf courses and large commercial sites. Rain Bird's Pump Station Platforms are designed for both new construction projects and renovation projects

Available in the following configurations:

- Vertical Turbine Pump Stations for Wet-well Applications
- Horizontal End Suction for Flooded Suction and Pressure Boosting Applications
- Multistage Pumps for Flooded Suction, Suction Lift, and Pressure Boosting Applications

Benefits:

- Enhanced Serviceability: Modern electrical design utilizing industrial breaker motor protection instead of time-wasting fuses. Industrial circuit breakers are quickly reset and designed for an extended service life
- Reduced Downtime: Industrial circuit breakers are good for thousands of trips
- Easy Operator Training: English and Spanish color touch-screen that is easy to learn
- Reduced Cost: Our powder coat paint earned the highest rating on ASTM corrosion tests. Less corrosion equals longer pipe, skid, and manifold life, reducing cost
- No-Hassle Buying: Get everything you need for your irrigation system construction or renovation from the only manufacturer dedicated to irrigation for over seven decades
- Real-Time Communication: The pump station communications in real-time with the central, allowing the central to make immediate decisions to maximize the efficiency of the entire irrigations systems

Electrical Power Specifications:

- 60 Hz, 3-Phase Power: 208V - 230V (up to 60HP per pump), 460V, 575V
- 50 Hz, 3-Phase Power: 380V, 415V
- Other power configurations available upon request

Options:

- Air Conditioned Electrical Panel Cooling System
- Enclosures: Aluminum, Painted Steel (Government Specified Colors)
- Fertigation Systems
- Filtration: Backwashing Screen Filters and Suction Scan Filters (Hydraulic or Electric)
- Heater, Skid Mounted 5KW
- Intake Box Screen with 3 Stainless Steel Screens
- Intermediate Pump, 10-25HP
- Lake Level Control: Float Switch and Ultrasonic
- Magnetic Flow Meter
- Modem, Radio or Hard-wired
- Power Zones: 3, 5, or 10KVA
- Premium Efficient Motors
- VFD per pump
- Wye Strainer with Auto Back-flush
- Z Discharge Pipe



Pump Manager with SmartPump™

- Combine a Rain Bird Pump Station and central control software to fully integrate pump station operation with your central control. This combination allows the pump station and central control to respond to changes in the system and irrigation immediately, providing the highest level of efficiency
- Smart Pump™ matches the irrigation system operation with the real capacity of the pump station, shortening the water window by an average of 20 percent and decreasing energy consumption. In addition, Smart Pump alerts the superintendent in real time of irrigation and pump station problems via cell phone text messaging. When an issue occurs such as an irrigation pipe break, the system verifies the break, shuts down the system and notifies the superintendent. Other systems cannot respond in a timely manner and can lose an hour of irrigation time trying to recover from a system fault



Need Help Specifying a Pump?

- Email pumps@rainbird.com or call 520-806-5620 for assistance with quotes and specifications

PSR and PSRP Pump Start Relays

For Optimum Pump Performance and Protection

Features

- Universal Rain Bird Pump start relays (PSR's) provide worry free performance for your irrigation system and are compatible with all Rain Bird and other reliable irrigation controllers
- Choose the PSRP for dry-run protection. An added pressure switch ensures additional protection in the event that you lose water pressure from the source

PSR Universal Pump Start Relay Features

- Works with a lawn controller's start/stop command to facilitate the electrical path from the breaker box to the pump motor
- Provide "pilot duty" operation for all types of electrically driven pump equipment with available coil voltages of 24, 110 and 220 VAC
- 40 AMP certified relay
- Quick connect terminals with wire nuts
- Grounding provision
- Compatible with 24 VAC timed lawn controllers
- Compatible with 110 or 220 VAC 3/4 hp thru 5 hp* single phase pumps
- Grey "baked-on" powder coating, for long life in difficult environments
- UL Listed as "Enclosed Industrial Control Panels" and backed by a limited two-year warranty
- Housed in compact NEMA 3R weather tight enclosures

PSRP Pump Start Relay Features

- Monitors an irrigation system through the use of a pressure sensor located on the discharge side of a pump to protect the pump from damage due to low pressure. If pressure has not recovered over the timer cycle, the pump shuts down to save itself before damage occurs
- Automatic pressure sensor reset
- 40 AMP certified relay
- 4-wire color coded wiring for easy installation
- Grounding Provision
- Completely automatic pump protection
- Adjustable time delay
- Bridges the gap between 24 VAC lawn controllers and 110/220V pump motors
- One model works for all pumps from 3/4 hp to 5 hp*
- Low pressure sensor protects the pump if the inlet water flow is restricted, reduced, or completely blocked
- Housed in NEMA 3R weathertight enclosures with "baked-on" powder coating for long life in difficult environments

** when thermal protection is present*



PSR and PSRP
Pump Start Relays

"G-Series" Hydraulic Suction Scanning Screen Filter

Economy and Value with Lower Backwash Volumes

MADE IN THE U.S.A.

Features

- Provides worry free medium-flow rate filtered water quality
- Powered by source line water pressure, the filter's backwashing system produces a concentrated high velocity and low volume reverse water flow to systematically clean the screen of any entrapped contaminants
- Models are available as a filter unit only, or as a filter assembly including bypass plumbing and valves for fast and easy installation on site
- Heavy-duty, durable, SS woven wire mesh screen filtration element with PVC support is supplied standard. Other screen construction including multi-layer sintered SS and wedgewire are also optionally available upon request.
- Standard SS woven screens are available in 50, 80, 100, 125, 150, 200 or 300 micron.
- Standard flow rates from 25 to 3,500 GPM
- Standard maximum operating pressure of 150 PSI (higher pressures optionally available)

- Filtered, clean water backwashing initiated automatically by time or pressure differential via integrated Rain Bird controller
- Flanged inlet and outlet standard except on models HS-V-01 and HS-G-02 filter only configurations which are threaded. Grooved inlet and outlet configuration optionally available.



G-Series
Shown with integrated bypass
assembly for fast and easy
installation.

"G-Series" Suction Scanning Screen Filter Performance Data

Powder Coated Carbon Steel Model Number	Stainless Steel Model Number	Maximum Flow US GPM	m ³ /Hour	Max Pressure (psi)	Inlet / Outlet Flange Size (in)	Flush Line Size (in)	Minimum Inlet Pressure During Rinse Cycle (psi)
Filter Only							
HS-V-01-LE-M	HS-V-01-LE-S-M	25	5.7	150	2	2	30
HS-G-02-LE-M	HS-G-02-LE-S-M	100	22.7	150	2	2	30
HS-G-03-LE-M	HS-G-03-LE-S-M	200	45.4	150	3	2	30
HS-G-04-LS-M	HS-G-04-LS-S-M	300	68.1	150	4	2	30
HS-G-04-LE-M	HS-G-04-LE-S-M	400	90.9	150	4	3	30
HS-G-06-LS-M	HS-G-06-LS-S-M	650	147.6	150	6	3	30
HS-G-06-LE-M	HS-G-06-LE-S-M	850	193.1	150	6	3	30
HS-G-08-LS-M	HS-G-08-LS-S-M	1300	295.3	150	8	3	30
HS-G-10-LS-M	HS-G-10-LS-S-M	1750	397.5	150	10	3	30
Filter Assembly with Bypass Manifold							
HS-V-01-LE-B-M	HS-V-01-LE-S-B-M	25	5.7	150	2	2	30
HS-G-02-LE-B-M	HS-G-02-LE-S-B-M	100	22.7	150	2	2	30
HS-G-03-LE-B-M	HS-G-03-LE-S-B-M	200	45.4	150	3	2	30
HS-G-04-LS-B-M	HS-G-04-LS-S-B-M	300	68.1	150	4	2	30
HS-G-04-LE-B-M	HS-G-04-LE-S-B-M	400	90.9	150	4	3	30
HS-G-06-LS-B-M	HS-G-06-LS-S-B-M	650	147.6	150	6	3	30
HS-G-06-LE-B-M	HS-G-06-LE-S-B-M	850	193.1	150	6	3	30
HS-G-08-LS-B-M	HS-G-08-LS-S-B-M	1300	295.3	150	8	3	30
HS-G-10-LS-B-M	HS-G-10-LS-S-B-M	1750	397.5	150	10	3	30
DS-G-060-LE-B-M	DS-G-06-LE-S-B-M	1700	386.2	150	10	3	30
DS-G-080-LS-B-M	DS-G-08-LS-S-B-M	2600	590.6	150	10	3	30
DS-G-100-LS-B-M	DS-G-10-LS-S-B-M	3500	795.0	150	12	3	30

M denotes Commercial model number. Contact Rain Bird for drawings or visit www.rainbird.com to download.

Filter flow is based on 200 micron or greater filtration of clear irrigation water. Appropriate flow de-rating is required for excessive debris loads (silt, organics, algae, etc.), reclaim water and finer screens. Contact Rain Bird for filter selection assistance for these applications.

"I-Series" Hydraulic Suction Scanning Screen Filter

MADE IN THE U.S.A.

The High Performance Standard in Scanning Filtration

Features

- Provides worry free high-flow rate filtered water quality
- Powered by source line water pressure, the filter's backwashing system produces a concentrated high velocity reverse water flow to systematically clean the mesh screen of any entrapped contaminants
- Models are available as a filter unit only, or as a filter assembly including bypass plumbing and valves for fast and easy installation on site
- Heavy-duty, durable, SS woven wire mesh screen filtration element with PVC support is supplied standard. Other screen construction including multi-layer sintered SS and wedgewire are also optionally available upon request
- Optional SS screen sizes available for 50, 80, 100, 150, 200 or 300 micron
- Standard flow rates from 400 to 5,000 GPM
- Standard maximum operating pressure of 150 PSI (higher pressures optionally available)
- Filtered, clean water backwashing initiated automatically by time or pressure differential via integrated Rain Bird controller
- Flanged inlet and outlet standard. Grooved inlet and outlet configuration optionally available



I-Series

"I-Series" Suction Scanning Screen Filter Performance Data

Powder Coated Carbon Steel Model Number	Stainless Steel Model Number	Maximum Flow US GPM	m ³ /Hour	Max Pressure (psi)	Inlet / Outlet Flange Size (in)	Flush Line Size (in)	Minimum Inlet Pressure During Rinse Cycle (psi)
Filter Only							
HS-I-04-PE-M	HS-I-04-PE-S-M	400	90.9	150	4	4	30
HS-I-06-PE-M	HS-I-06-PE-S-M	650	147.6	150	6	4	30
HS-I-08-PS-M	HS-I-08-PS-S-M	1200	272.6	150	8	4	30
HS-I-08-PE-M	HS-I-08-PE-S-M	1500	340.7	150	8	4	30
HS-I-10-PS-M	HS-I-10-PS-S-M	1750	397.5	150	10	4	30
HS-I-10-PE-M	HS-I-10-PE-S-M	2000	454.3	150	10	4	30
HS-I-12-PS-M	HS-I-12-PS-S-M	2500	567.9	150	12	4	30
Filter Assembly with Bypass Manifold							
HS-I-04-PE-B-M	HS-I-04-PE-S-B-M	400	90.9	150	4	4	30
HS-I-06-PE-B-M	HS-I-06-PE-S-B-M	650	147.6	150	6	4	30
HS-I-08-PS-B-M	HS-I-08-PS-S-B-M	1200	272.6	150	8	4	30
HS-I-08-PE-B-M	HS-I-08-PE-S-B-M	1500	340.7	150	8	4	30
HS-I-10-PS-B-M	HS-I-10-PS-S-B-M	1750	397.5	150	10	4	30
HS-I-10-PE-B-M	HS-I-10-PE-S-B-M	2000	454.3	150	10	4	30
HS-I-12-PS-B-M	HS-I-12-PS-S-B-M	2500	567.9	150	12	4	30
DS-I-08-PE-B-M	DS-I-08-PE-S-B-M	3000	681.5	150	12	4	30
DS-I-10-PS-B-M	DS-I-10-PS-S-B-M	3500	795.0	150	12	4	30
DS-I-10-PE-B-M	DS-I-10-PE-S-B-M	4000	908.6	150	14	4	30
DS-I-12-PS-B-M	DS-I-12-PS-S-B-M	5000	1135.8	150	14	4	30

* Filter flow is based on 200 micron filtration of clear irrigation water. Appropriate flow de-rating is required for excessive debris loads (silt, organics, algae, etc.), reclaim water and finer screens. Contact Rain Bird for filter selection assistance for these applications. -M denotes Commercial model number Contact Rain Bird for drawings or visit www.rainbird.com to download.

Automatic Backwashing Screen Filter

MADE IN THE U.S.A.

High Performance with Fewer Moving Parts

Features

- Available as filter only (no bypass plumbing) or as a complete assembly with bypass plumbing and valves for easy installation
- Heavy-duty, durable, wedge-wire screen filtration element
- Flow rates from 250 to 4,000 GPM
- Standard maximum operating pressure: 150 PSI (higher pressures optionally available)
- Optional screen sizes available for 40, 60, 80, 100 or 150 mesh
- Vertical configuration designed for limited space applications
- Large screen area provides long runs between backwash cycles
- Filtered, clean water backwashing automatically initiated by time or pressure differential
- Flanged inlet and outlet standard. Grooved inlet and outlet configuration optionally available
- Optional solar package and DC latching solenoid available. Solar package includes a solar panel, battery pack, metering system, wiring harness and enclosure box
- No moving parts inside the filter canister to wear out



Automatic Backwashing Screen Filter
(shown as filter only)



Rain Bird's cast valves feature durable fusion epoxy lining, stainless steel trim and molded polyurethane seals

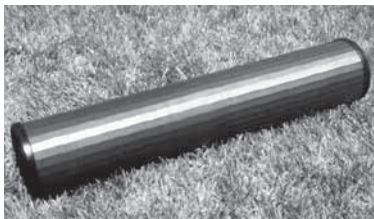

The stainless steel filter cartridge requires limited seasonal maintenance

Automatic Backwashing Screen Filter Performance Data

Model Number	Maximum Flow US GPM	m ³ /Hour	Max Pressure (PSI)	Inlet / Outlet Flange Size (in)	Flush Line Size (in)
Filter Only					
BSF6-2-M	250	56.8	150	4	2
BSF8-2-M	500	113.6	150	6	2
BSF8-3-M	750	170.4	150	6	2
BSF10-2-M	1000	227.2	150	8	4
BSF10-3-M	1500	340.7	150	8	4
BSF10-4-M	2000	454.3	150	10	4
BSF10-5-M	2500	567.9	150	10	4
BSF10-6-M	3000	681.5	150	12	4
BSF10-7-M	3500	567.9	150	12	4
BSF10-8-M	4000	908.6	150	14	4
Filter Assembly with Bypass Manifold					
BSF6-2-B-M	250	56.8	150	4	2
BSF8-2-B-M	500	113.6	150	6	2
BSF8-3-B-M	750	170.4	150	6	2
BSF10-2-B-M	1000	227.2	150	8	4
BSF10-3-B-M	1500	340.7	150	8	4
BSF10-4-B-M	2000	454.3	150	10	4
BSF10-5-B-M	2500	567.9	150	10	4
BSF10-6-B-M	3000	681.5	150	12	4
BSF10-7-B-M	3500	567.9	150	12	4
BSF10-8-B-M	4000	908.6	150	14	4

Filter flow is based on 250 micron filtration of clear irrigation water. Appropriate flow de-rating is required for excessive debris loads (silt, organics, algae, etc.), reclaim water and finer screens. Contact Rain Bird for filter selection assistance for these applications.

-M denotes Commercial model number Contact Rain Bird for drawings or visit www.rainbird.com to download.

Self-Cleaning Pump Suction Screen

MADE IN THE U.S.A.

Keep Debris Out of Your Pump and Irrigation System

Features

- Galvanized, Self-Cleaning Pump Suction Screen removes large trash and debris from water sources, saving time and money in energy, pumping efficiency and maintenance costs
- Heavy 12 or 24 mesh stainless steel screen increases your pump efficiency for many years to come
- All water must pass through the pump suction screen attached to the end of the pump suction line before entering the pump intake pipe. A small, side-stream from the pump discharge plumbing drives two spray bars that continually rotate, jetting water at the screen and blasting debris away

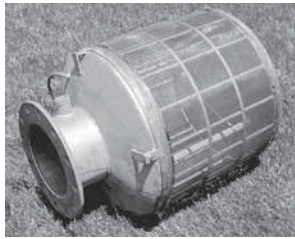

Self-Cleaning Pump Suction Screen Performance Data

Model Number	Flow US GPM	Flow m ³ /Hour	Screen Length (in)	Total Length (in)	Screen Diameter (in)	Flange Size (in)	Return Inlet Pipe Size (in)	Operating Pressure (min - max psi)	Weight Lbs.	Cleaning Spray (GPM)
12 Mesh Filter										
PSS200-M	325	73.8	11	25	16	4	1.5	35-100	38	20
PSS400-M	550	124.9	15	28.8	16	6	1.5	40-100	57	20
PSS600-M	750	170.3	16	32.5	24	8	1.5	40-100	101	20
PSS800-M	950	215.7	18	34.5	24	10	1.5	45-100	108	20
PSS1000-M	1350	306.5	23	39.5	24	10	1.5	50-100	116	24
PSS1400-M	1650	374.6	26	42.5	24	12	1.5	55-100	128	24
PSS1700-M	1950	442.7	28	44.5	26	12	1.5	55-100	148	24
PSS2000-M	2350	533.5	32	48.5	26	14	1.5	60-100	160	24
PSS2400-M	2600	590.2	35	52.5	30	16	1.5	65-100	223	28
PSS3000-M	3000	681.0	40	57.5	30	16	1.5	40-65	236	44
PSS3500-M	3500	794.5	40	59.5	36	18	1.5	40-65	283	44
PSS4000-M	4000	908.0	40	63.5	42	18	1.5	40-65	358	44
24 Mesh Filter										
PSS20024-M	225	51.1	11	25	16	4	1.5	35-100	38	20
PSS40024-M	400	90.8	15	28.8	16	6	1.5	40-100	57	20
PSS60024-M	525	119.2	16	32.5	24	8	1.5	40-100	101	20
PSS80024-M	700	158.9	18	34.5	24	10	1.5	45-100	108	20
PSS100024-M	950	215.7	23	39.5	24	10	1.5	50-100	116	24
PSS140024-M	1200	272.4	26	42.5	24	12	1.5	55-100	128	24
PSS170024-M	1400	317.8	28	44.5	26	12	1.5	55-100	148	24
PSS200024-M	1650	374.6	32	48.5	26	14	1.5	60-100	160	24
PSS240024-M	1800	408.6	35	52.5	30	16	1.5	65-100	223	28
PSS300024-M	2075	471.0	40	57.5	30	16	1.5	40-65	236	44
PSS350024-M	2420	549.3	40	59.5	36	18	1.5	40-65	283	44
PSS400024-M	2765	627.7	40	63.5	42	18	1.5	40-65	358	44

-M denotes Commercial model number Contact Rain Bird for drawings or visit www.rainbird.com to download.

Centrifugal Sand Separator

MADE IN THE U.S.A.

Remove contaminants to minimize required maintenance and increase efficiency

Features

- Capacities of 4 to 8300 gpm
- Simple installation (no electrical power required)
- Efficient pre-filter to reduce sand load on downstream components
- Rain Bird Centrifugal Sand Separators are designed to separate abrasive particles before they can enter the irrigation system, keeping equipment clean and clear of debris, which minimizes the amount of maintenance required and increases operational efficiency
- The separator removes sand and particles that are heavier than water (materials with a specific gravity of 2 or greater)
- Liquids and solids enter the unit and begin traveling in a circular flow. This centrifugal action throws heavier particulates towards the filter walls and eventually downward in a spiral motion to the separation chamber. The particulates collect in the separation chamber and are purged manually from the system. The filtered water is then drawn to the separator's vortex and through the outlet
- An optional automatic purge controller and valve can be used on all applications to automate the purge process, which eliminates the need for manual flushing. Small vertical design separators may be wall mounted or supported by the system piping



Centrifugal Sand Separator

Centrifugal Sand Separators Performance Data

Model Number	Flow* US GPM	Flow m ³ /Hour	Inlet / Outlet Line Size (in)	Length (in)	Length (cm)	Weight Lbs.	Max. Particle Size (in)	Flush Valve Size (in)
Vertical Separators								
VCS-R5V-M	4 - 10	0.9 - 2.3	0.5	20	50.8	13	0.625	1
VCS-R7V-M	10 - 20	2.3 - 4.6	0.75	20	50.8	15	0.375	1
VCS-R10V-M	18 - 38	4 - 8.7	1	30.5	77.5	26	0.5	1
VCS-R12V-M	26 - 52	6 - 12	1.25	30.5	77.5	26	0.5	1
VCS-R15V-M	38 - 79	8.7 - 18	1.5	30.5	77.5	26	0.5	1
VCS-R20V-M	63 - 120	14.5 - 27.6	2	36	91.4	44	0.5	2
VCS-R25V-M	100 - 180	23 - 41.4	2.5	44	111.8	55	0.5	2
VCS-R30V-M	125 - 260	28.8 - 59.8	3	48	121.9	75	0.5	2
VCS-R40V-M	190 - 345	43.7 - 79.4	4	52	132.1	120	0.5	2
Angled Separators								
ACS-R40LA-M	200 - 525	46 - 120	4	80	221	280	1.5	2
ACS-R60LA-M	365 - 960	84 - 220	6	106.25	293.4	493	1.5	2
ACS-R80LA-M	800 - 1600	184 - 369	8	114	316.9	722	1.5	2
ACS-R100LA-M	1300 - 2300	299 - 529	10	123.5	342.9	840	1.5	2
ACS-R120LA-M	2025 - 3400	465 - 782	12	139	396.2	1400	1.5	2
ACS-R140LA-M	2975 - 5000	684 - 1150	14	148	424.2	1550	2	2
ACS-R160LA-M	4000 - 6200	920 - 1426	16	160	462.3	1850	2	2
ACS-R180LA-M	5100 - 8300	1173 - 1909	18	177	462.3	2400	2	3

Filter flow is based on 200 micron or greater filtration of clear irrigation water. Appropriate flow de-rating is required for excessive debris loads (silt, organics, algae, etc.), reclaim water and finer screens. Contact Rain Bird for filter selection assistance for these applications.

HDF Series Disc Filters

Automatic self-cleaning disc filtration equipment

Features

- Automatic self-cleaning disc filtration equipment with 2" or 4" valves and high density polyethylene manifolds
- Ideal for Surface and well water containing both organic (algae) and inorganic materials- Rivers, reservoirs, canals and waste water, Well water containing light sand (<3PPM) and other contaminants
- The Rain Bird HDF patented systems helical action provides efficient cleaning
- Manufactured from engineered plastics to resist rust and corrosion from chemicals and water
- All units are factory tested prior to shipment
- Disc elements provide depth filtration -not just surface filtration
- Unit is pre-assembled with HDPE (High –density polyethylene) manifold for easy installation
- DP, time or manual backflush cycle can be imitated from the controller
- Plastic backflush valves are lightweight and corrosion resistant.
- Low maintenance and performs reliable backflush
- Filtration disc versatility (filtration grades can be easily changed)
- Available with 100, 130, 200 or 400 micron discs (specify when ordering)

Rain Bird HDF Series 2 systems backwash one station at a time while the remaining elements continue filtering.

- **FILTRATION STAGE:** The discs generate a centrifugal helical effect upon entry into the filter, moving the particles away from the discs. The water then passes efficiently through the depth of the uniquely designed discs
- **BACKFLUSHING STAGE:** The clean water from the auxiliary filter is introduced from the reverse direction through the filtering element. This decompresses the stack discs, allowing the discs to separate and backwash efficiently

Rain Bird HDF Series 1X2 filters backwash successively.

- **FILTRATION STAGE:** As water goes through the discs, particles are projected away due to the cyclone effect, reducing the backflushing frequency
- **BACKFLUSHING STAGE:** Water is projected through the discs, expelling the retained particles and evacuating them through the drainage manifold while the rest of the equipment is still in the filtration stage, supplying the remaining installation
- **FILTRATION STAGE:** The discs generate a centrifugal helical effect upon entry into the filter, moving the particles away from the discs. The water then passes efficiently through the depth of the uniquely designed discs
- **BACKFLUSHING STAGE:** The clean water from the auxiliary filter is introduced from the reverse direction through the filtering element. This decompresses the stack discs, allowing the discs to separate and backwash efficiently



HDF Series 1x2 Disc Filters



Rain Bird Filtron 110 Control Unit allows backwash activation by time or pressure differential.

Control Units are available in 12 VDC, 110 VAC and 220 VAC.



HDF Series 2 Disc Filters



HDF Series 4 Disc Filters

HDF Series Disc Filters (cont.)

Specifications

HDF Series 1x2 Disc Filters

- Suited for areas with or without electricity.
- Ideal where manual cleaning is troublesome.
- Compact design fits in tight spaces.
- Control Unit functions on pressure differential or time.
- Automatic self-cleaning 2" filter for low flow ranges.
- Maximum Flow: 106 gpm (24 m³/h)
- Maximum filtering surface (231 in²/1492 cm²).
- Maximum pressure: 145 psi (10 bar)
- Maximum temperature: 140° F (60° C)
- Standard filtration options: 100 micron (140 mesh), 130 micron (120 mesh), and 200 micron (75 mesh).

HDF Series 2 Disc Filters

- Suitable for surface and well waters containing both organic (algae) and inorganic materials.
 - Rivers, reservoirs, canals and waste water
- Well water containing light sand (<3 PPM) and other contaminants.
- Maximum flow: 845 gpm (192 m³/h)
- Maximum filtering surface: (231 in²/1492 cm²)
- Maximum pressure: 145 psi (10 bar)
- Maximum temperature: 140° F (60° C)
- Standard filtration options: 100 micron (140 mesh), 130 micron (120 mesh), and 200 micron (75 mesh).
- Custom filtration options: 20 micron and 50 micron available by special request.

HDF Series 4 Disc Filters

- Suitable for surface and well waters containing both organic (algae) and inorganic materials.
 - Rivers, reservoirs, canals and waste water
- Suited for areas with or without electricity.
- Well water containing light sand (<3 PPM) and other contaminants.
- Ideal for high flow rate applications.
- Maximum flow: 3945 gpm (896 m³/h)
- Maximum filtering surface (463 in²/2984 cm²)
- Maximum pressure: 145 psi (10 bar)
- Maximum temperature: 140° F (60° C)
- Standard filtration options: 100 micron (140 mesh), 130 micron (120 mesh), and 400 micron (40 mesh).
- Custom filtration options: 200 micron (75 mesh) and 50 micron available by special request.

Options

- Rain Bird Filtron 110 allows backwash activation by time or pressure differential. Controllers are available in 12 VDC, 110 VAC and 220 VAC.

HDF Series 1x2 Disc Filters Specifications				
Model Number	Number of Filters	Manifold	Filtering Surface	
			(in)	(cm)
1X2/2G	1-2"	Inlet: 2" PVC Outlet: 2" NPT Drainage: 2" NPT	231	1492

HDF Series 2 Disc Filters Specifications				
Model Number	Number of Filters	Manifold	Filtering Surface	
			(in)	(cm)
202/3VX	2" x 2	2" PVC	463	2984
203/4VX	2" x 3	4" PVC	694	4476
204/6VX	2" x 4	6" PVC	925	5968
205/6VX	2" x 5	6" PVC	1156	7460
206/6VX	2" x 6	6" PVC	1388	8952
207/6VX	2" x 7	6" PVC	1619	10444
208/8VX	2" x 8	8" PVC	1850	11936

HDF Series 4 Disc Filters Specifications				
Model Number	Number of Filters	Manifold	Filtering Surface	
			(in)	(cm)
403/8VX	4" x 3	8" PVC	1388	8952
404/8VX	4" x 4	8" PVC	1850	11936
405/10VX	4" x 5	10" PVC	2313	14920
406/10VX	4" x 6	10" PVC	2313	14920
407/10VX	4" x 7	10" PVC	3238	20888
408/12VX	4" x 8	12" PVC	3700	23872
409/12VX	4" x 9	12" PVC	4163	26856
410/12VX	4" x 10	12" PVC	4625	29840
411/12VX	4" x 11	12" PVC	5088	32824
412/12VX	4" x 12	12" PVC	5550	35808

Drainage manifolds included - Grooved connection.

Dimensions of the models with flange connection. 2", 3", 4", 6" and 8" Dyrson grooved flanges are available.

Consult factory for other configurations.

Rain Bird reserves the right to change the characteristics of these products without prior notice.



The newest name in drainage is the one you already trust.

For decades, we've been finding new ways to use water more intelligently. We're proud to introduce a few more: Rain Bird drainage products. Ruggedly constructed and designed to work together, these drainage grates, basins, adapters and accessories can help you efficiently manage water run-off for virtually any residential, commercial or municipal site. Put them in the ground. You'll see why they're the first drainage products worthy of the Rain Bird name.



Water Saving Tips

- Installing a well-designed drainage system will result in the collection and capture of rain, runoff water and standing water from the site.
- The collected water can then be directed to an on-site storage tank, treated (if required) and pumped on an "as needed" basis to feed a Rain Bird water efficient irrigation system.
- Drainage systems can reduce damage to structures by directing water away from the foundation of the structure to a more desirable area on the site.
- A Rain Bird Drainage Pop-Up Valve (DPUV) can be installed at the lowest point of the piping network to allow for the collected water to slowly percolate into the soil and recharge the ground water supply.
- A properly installed drainage system can eliminate issues on the site caused by rushing or standing water which can result in soil erosion, plant disease and structural damage.
- Remember, water always runs downhill. Make sure that there is at least a 2% elevation difference between the high-end and the low-end of the drainage system.

New Product Category. Same Toughness.

No shortcuts here. Our grates, basins and drainage accessories were engineered with the same exacting standards of a Rain Bird spray head, valve or controller.

Proven Reliability

We have a reputation to protect. Rain Bird drainage products are built using the highest quality materials and rigorously tested for durability.

Three-Year Warranty

You need products that will last long after the job's done. That's why we stand behind our drainage products with the longest warranty in the drainage product category.

All Rain Bird drainage purchases qualify for valuable Rain Bird Rewards points.

Round Catch Basin

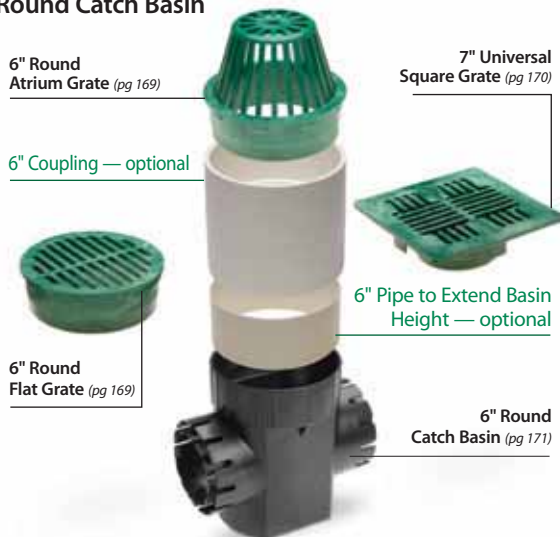

Compatible Drainage Pipe

(not manufactured by Rain Bird)



Color, Size and Style are Optional. Loose Fits are Not.

No matter the job, you'll have the equipment you need to do it right. We offer grates and basins of varying dimensions, shapes and colors—all designed to fit together for tight, worry-free connections.

Recycled Plastics

All drainage models are constructed from 100% recycled plastic and therefore qualify for points on LEED projects.

Full Compatibility

Any way you put them together, our grates and basins will give you the best fit. For easy upgrades and quick replacements, our products are also compatible with components from most other drainage manufacturers.

Low-Profile Basin

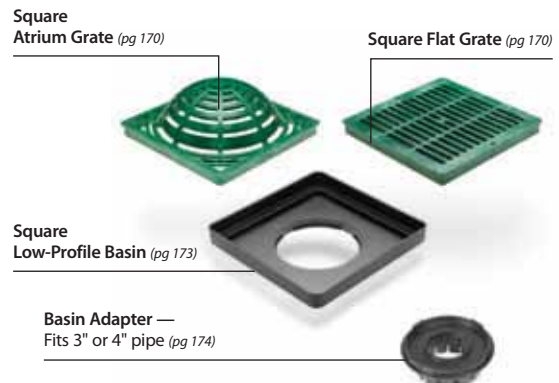

Square Catch Basin

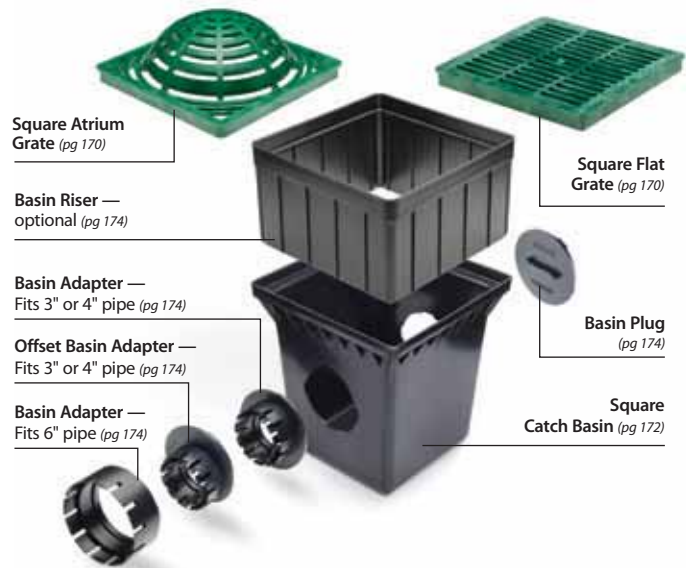

Plastic Round Grates

Features

- Manufactured from structurally foamed High-Density Polyethylene (HDPE)
- UV stabilized to protect from sun degradation
- Each grate has three stepped diameters to fit Sewer and Drain (S & D) Pipe and Fittings, Triple Wall Pipe and Corrugated Pipe
- Textured anti-skid surface¹
- Load rated for pedestrian traffic^{1,2}
- Load rated for autos and light trucks at speeds less than 20 mph^{1,2}
- ADA compliant¹

Flat



3"
DG3RFG



4"
DG4RFG



6"
DG6RFG

Atrium



3"
DG3RAG



4"
DG4RAG



6"
DG6RAG

Model Number	Color	Each Diameter Fits			Open Slot Width	Open Surface Area	Maximum Flow Rating	Maximum Load
		Small	Medium	Large				
3" Round Flat								
DG3RFG	Green	3" Triple Wall Pipe	3" S & D Pipe (ASTM D2729)	3" S & D Fittings (SDR 35)	3/16"	3 sq in	3 GPM	500 lbs
DG3RFB	Black		3" Corrugated Pipe					
4" Round Flat								
DG4RFG	Green	4" Triple Wall Pipe	4" S & D Pipe (ASTM D2729)	4" S & D Fittings (SDR 35)	1/4"	5 sq in	6 GPM	750 lbs
DG4RFB	Black		4" Corrugated Pipe					
6" Round Flat								
DG6RFG	Green	6" Sewer Pipe (ASTM D3034, SDR 35)	6" S & D Pipe (ASTM D2729)	6" S & D Fittings (SDR 35) 6" Round Catch Basins (DB6R1 & DB6R2)	5/16"	13 sq in	16 GPM	1,000 lbs
DG6RFB	Black		6" Corrugated Pipe					
3" Round Atrium								
DG3RAG	Green	3" Triple Wall Pipe	3" S & D Pipe (ASTM D2729)	3" S & D Fittings (SDR 35)	1/4"	9 sq in	12 GPM	NA
DG3RAB	Black		3" Corrugated Pipe					
4" Round Atrium								
DG4RAG	Green	4" Triple Wall Pipe	4" S & D Pipe (ASTM D2729)	4" S & D Fittings (SDR 35)	5/16"	16 sq in	20 GPM	NA
DG4RAB	Black		4" Corrugated Pipe					
6" Round Atrium								
DG6RAG	Green	6" Sewer Pipe (ASTM D3034, SDR 35)	6" S & D Pipe (ASTM D2729)	6" S & D Fittings (SDR 35) 6" Round Catch Basins (DB6R1 & DB6R2)	3/8"	28 sq in	36 GPM	NA
DG6RAB	Black		6" Corrugated Pipe					

¹Flat grate only

²Maximum load rating based on basin encased in concrete and weight uniformly applied across entire grate surface

Plastic Square Grates

Features

- Manufactured from structurally foamed High-Density Polyethylene (HDPE)
- UV stabilized to protect from sun degradation
- Textured anti-skid surface¹
- Load rated for autos and light trucks at speeds less than 20 mph^{1,2}
- Includes two screw holes to secure to basin³
- ADA compliant¹

Flat

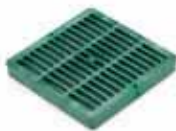

9"

DG9SFG

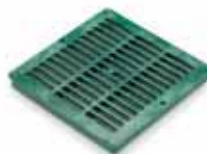

12"

DG12SFG

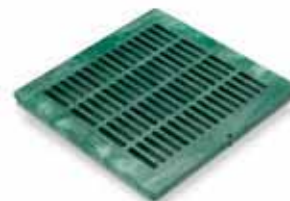

18"

DG18SFG

Atrium



9"

DG9SAG



12"

DG12SAG

Model Number	Color	Fits	Open Slot Width	Open Surface Area	Maximum Flow Rating	Maximum Load
9" Square Flat						
DG9SFG	Green	9" Square Catch Basin (DB9S2)	3/8"	38 sq in	50 GPM	2,000 lbs
DG9SFB	Black	9" Low-Profile Basin (DB9SLP)				
12" Square Flat						
DG12SFG	Green	12" Square Catch Basins (DB12S2 & DB12S4)	7/16"	53 sq in	70 GPM	3,000 lbs
DG12SFB	Black	12" Low-Profile Basin (DB12SLP)				
18" Square Flat						
DG18SFG	Green	18" Square Catch Basins (DB18S2 & DB18S4)	15/32"	92 sq in	120 GPM	4,000 lbs
DG18SFB	Black					
9" Square Atrium						
DG9SAG	Green	9" Square Catch Basin (DB9S2)	3/8"	31 sq in	40 GPM	NA
DG9SAB	Black	9" Low-Profile Basin (DB9SLP)				
12" Square Atrium						
DG12SAG	Green	12" Square Catch Basins (DB12S2 & DB12S4)	7/16"	50 sq in	65 GPM	NA
DG12SAB	Black	12" Low-Profile Basin (DB12SLP)				

¹Flat grate only

²Maximum load rating based on basin encased in concrete and weight uniformly applied across entire grate surface

³Use #6 1.5" long Phillips flat head stainless screws

Universal Square Grates

Features

- Manufactured from structurally foamed High-Density Polyethylene (HDPE)
- UV stabilized to protect from sun degradation
- Textured anti-skid surface
- Load rated for pedestrian traffic¹
- ADA compliant



DG7USG

Model Number	Color	Fits	Open Slot Width	Open Surface Area	Maximum Flow Rating	Maximum Load
7" Universal Square Flat						
DG7USG	Green	<ul style="list-style-type: none"> • 6" Round Catch Basin (DB6R1, DB6R2) • 3" or 4" S & D Pipe (ASTM D2729) • 3" or 4" Corrugated Pipe 	1/4"	13 sq in	11 GPM	250 lbs
DG7USB	Black	<ul style="list-style-type: none"> • 3" or 4" Triple Wall Pipe • 3", 4" or 6" S & D Fittings (SDR 35) 				

¹Maximum load rating based on basin encased in concrete and weight uniformly applied across entire grate surface

Round Catch Basins

Features

- Manufactured from High-Impact Polystyrene (HIPS)
- UV stabilized to protect from sun degradation
- Universal outlet(s) used to connect to 3" or 4" Sewer and Drain Pipe (ASTM D2729), 3" or 4" Corrugated Pipe and 3" or 4" Triple Wall Pipe
- Includes a sump to allow sediment to settle in basin to minimize clogging of pipes
- To extend height of basin, use 6" PVC Pipe (ASTM D2729 and ASTM D3034, SDR 35) as a riser



DB6R1

DB6R2

Model Number	Number of Outlets	Inlet (Top) Accepts	Outlet (Side) Fits	Capacity	Sump Capacity
6" Round					
DB6R1	1	<ul style="list-style-type: none"> • 6" Round Flat and Atrium Grates • 7" Universal Square Grates 	<ul style="list-style-type: none"> • 3" or 4" Corrugated Pipe • 3" or 4" Triple Wall Pipe 	0.80 gals	0.20 gals
DB6R2	2	<ul style="list-style-type: none"> • 6" PVC Pipe (ASTM D2729, ASTM D3034, SDR 35) 	<ul style="list-style-type: none"> • S & D Pipe (ASTM D2729) 		

Square Catch Basins

Features

- Manufactured from High-Density Polyethylene (HDPE)
- UV stabilized to protect from sun degradation
- Use a 3" and 4" Basin Adapter to connect basin to 3" or 4" Corrugated Pipe and 3" or 4" Triple Wall Pipe
- Use a 6" Basin Adapter to connect basin to 6" PVC Pipe (ASTM D2729 and ASTM D3034, SDR 35) and 6" Corrugated Pipe
- Use a Basin Plug to plug unused outlets
- Use 9" or 12" Square Basin Riser(s) to extend height of 9" and 12" Square Catch Basins by 6" in height, respectively
- Includes a sump to allow sediment to settle in basin to minimize clogging of pipes
- Includes four screw holes to enable grates to be secured to basin



Model Number	Number of Outlets	Inlet (Top) Accepts	Outlet (Side) Fits	Capacity	Sump Capacity
9" Square, 2 Outlets					
DB9S2	2	<ul style="list-style-type: none"> • 9" Square Flat Grates • 9" Square Atrium Grates • 9" Square Basin Riser (DBRE9) 	<ul style="list-style-type: none"> • Basin Plug (DBAAP) • 3" & 4" Basin Adapter (DBAA34 or DBAAO34) • 6" Basin Adapter (DBAA6) 	2.20 gals	0.45 gals
12" Square, 2 Outlets					
DB12S2	2	<ul style="list-style-type: none"> • 12" Square Flat Grates • 12" Square Atrium Grates • 12" Square Basin Riser (DBRE12) 	<ul style="list-style-type: none"> • Basin Plug (DBAAP) • 3" & 4" Basin Adapter (DBAA34 or DBAAO34) • 6" Basin Adapter (DBAA6) 	5.10 gals	1.25 gals
18" Square, 2 Outlets					
DB18S2	2	<ul style="list-style-type: none"> • 18" Square Flat Grates 	<ul style="list-style-type: none"> • Basin Plug (DBAAP) • 3" & 4" Basin Adapter (DBAA34 or DBAAO34) • 6" Basin Adapter (DBAA6) 	16.70 gals	4.90 gals

Square Low-Profile Basins

Features

- Manufactured from High-Impact Polystyrene (HIPS)
- UV stabilized to protect from sun degradation
- One bottom outlet designed to accept all Basin Adapters
- Use a 3" and 4" Basin Adapter to connect to 3" or 4" Corrugated Pipe and 3" or 4" Triple Wall Pipe
- Use a 6" Basin Adapter to connect to 6" PVC Pipe (ASTM D2729 and ASTM D3034, SDR 35) and 6" Corrugated Pipe
- Accepts 9" and 12" Square Flat Grates
- Accepts 9" and 12" Square Atrium Grates
- Includes two screw holes to enable grates to be secured to Low-Profile Basin
- Made in the USA



DB9SLP



DB12SLP

Model Number	Inlet (Top) Accepts	Outlet (Side) Fits
9" Square		
DB9SLP	<ul style="list-style-type: none"> • 9" Square Flat Grates • 9" Square Atrium Grates • 9" Square Basin Riser (DBRE9) 	<ul style="list-style-type: none"> • 3" & 4" Basin Adapter (DBAA34 or DBAAO34) • 6" Basin Adapter (DBAA6)
12" Square		
DB12SLP	<ul style="list-style-type: none"> • 12" Square Flat Grates • 12" Square Atrium Grates • 12" Square Basin Riser (DBRE12) 	<ul style="list-style-type: none"> • 3" & 4" Basin Adapter (DBAA34 or DBAAO34) • 6" Basin Adapter (DBAA6)

Square Basin Kits

For your convenience, Basin Kits are available with the most popular basin, grate and adapter components required on most jobs.

Model Number	Each Kit Includes	
9" Square Basin Kit		
DB9KITG	<ul style="list-style-type: none"> • 9" Square Basin with two outlets (DB9S2) • Two 3" and 4" Adapters (DBAA34) 	<ul style="list-style-type: none"> • Basin Plug (DBAAP) • 9" Square Flat Grate, GREEN (DG9SFG)
DB9KITB	<ul style="list-style-type: none"> • 9" Square Basin with two outlets (DB9S2) • Two 3" and 4" Adapters (DBAA34) 	<ul style="list-style-type: none"> • Basin Plug (DBAAP) • 9" Square Flat Grate, BLACK (DG9SFB)
12" Square Basin Kit (not shown)		
DB12KITG	<ul style="list-style-type: none"> • 12" Square Basin with two outlets (DB12S2) • Two 3" and 4" Adapters (DBAA34) 	<ul style="list-style-type: none"> • Basin Plug (DBAAP) • 12" Square Flat Grate, GREEN (DG12SFG)
DB12KITB	<ul style="list-style-type: none"> • 12" Square Basin with two outlets (DB12S2) • Two 3" and 4" Adapters (DBAA34) 	<ul style="list-style-type: none"> • Basin Plug (DBAAP) • 12" Square Flat Grate, BLACK (DG12SFB)



DB9KITG

Drainage Pop-Up Valves

Features

- Available in four configurations
- Pop-up valve body manufactured from structurally foamed High-Density Polyethylene (HDPE)
- Elbow (where applicable) manufactured from PVC
- Adapter (where applicable) manufactured from High Impact Polystyrene (HIPS)
- UV stabilized to protect from sun degradation
- Spring-loaded cover rises ½" to discharge excess water in system
- Spring automatically retracts cover to closed position after excess water is discharged
- Can be used in both vertical and horizontal position
- Stainless steel spring to prevent rusting
- PVC elbows (where applicable) include a ¼" drain hole to eliminate standing water
- Made in the USA



Model Number	Color	Description	Connects To
DPUV0	Green	Drainage Pop-Up Valve	<ul style="list-style-type: none"> • 3" or 4" S & D Fittings (SDR 35)
DPUV3E	Green	Drainage Pop-Up Valve with 3" PVC Elbow	<ul style="list-style-type: none"> • 3" S & D Pipe (ASTM D2729) • 3" Triple Wall Pipe
DPUV4E	Green	Drainage Pop-Up Valve with 4" PVC Elbow	<ul style="list-style-type: none"> • 4" S & D Pipe (ASTM D2729 & D3034) • 4" Triple Wall Pipe
DPUV4EHUB	Green	Drainage Pop-Up Valve with 4" PVC Elbow and Adapter (DPAFHA34)	<ul style="list-style-type: none"> • 3" or 4" Corrugated Pipe • 3" or 4" Triple Wall Pipe • 3" or 4" S & D Pipe (ASTM D2729)

Basin Adapters and Accessories



Model Number	Description	Use
DBAAP	Basin Plug	<ul style="list-style-type: none"> • Blocks 9", 12" & 18" Square Basin side outlets
DBAA34	3" and 4" Basin Adapter	<ul style="list-style-type: none"> • Adapts 9", 12" and 18" Square Basin side outlets and 9" & 12" Low-Profile Basin outlets to 3" or 4" PVC and Corrugated Pipe
DBAAO34	3" and 4" Offset Basin Adapter	<ul style="list-style-type: none"> • Adapts 9", 12" & 18" Square Basin side outlets and 9" & 12" Low-Profile Basin outlets to 3" or 4" PVC and Corrugated Pipe
DBAA6	6" Basin Adapter	<ul style="list-style-type: none"> • Adapts 9", 12" & 18" Square Basin side outlets and 9" & 12" Low-Profile Basin outlets to 6" PVC and Corrugated Pipe
DPAFH34	Fitting Adapter	<ul style="list-style-type: none"> • Adapts 3" or 4" Triple Wall Pipe to 3" or 4" PVC and Corrugated Pipe
DBRE9	9" Square Basin Riser	<ul style="list-style-type: none"> • Extends height of 9" Square Basin or 9" Low-Profile Basin by 6"
DBRE12	12" Square Basin Riser	<ul style="list-style-type: none"> • Extends height of 12" Square Basin or 12" Low-Profile Basin by 6"

Your 24/7 Information Resource

The Rain Bird website is your one-stop source for the latest product information and news updates from Rain Bird. Stop by anytime, day or night, and download exactly what you need to be more effective on the job. Learn about the newest Rain Bird products, look up performance charts, download CAD detail drawings and much more.

Visit www.rainbird.com today and explore this state-of-the-art resource.



Rain Bird Online Resources and Contacts List

Programs and Marketing Resources	Contacts/Information
Design and Specification Resources	www.rainbird.com/landscape (Select from product list in left menu)
Distributor Portal Website	ww2.rainbird.com/turfdistributor
Facebook	www.facebook.com/RainBirdCorp
Intelligent Use of Water™	www.rainbird.com/IUOW
LEED Library	www.rainbird.com/LEED
Maxicom Dollars	www.rainbird.com/maxicomdollars • E-mail: maxicom@rainbird.com
Photos and Logos	www.rainbird.com/library
Product Catalog	www.rainbird.com/catalog
Product Demos and Interactive Guides	www.rainbird.com/landscape (Select from product list in left menu)
Product Literature and Tech Specs	www.rainbird.com/landscape/support
Rain Bird Agency Rewards (non-profits and government agencies)	www.rainbird.com/agency • E-mail: rewards@rainbird.com
Rain Bird Rewards	www.rainbird.com/rewards • E-mail: rewards@rainbird.com
Rain Bird Training and Services	www.rainbirdservices.com
Rain Bird Virtual Museum	www.rainbird.com/museum
Twitter	www.twitter.com/rainbirdcorp
Water Efficiency Calculators	www.rainbird.com/calculators
Webinars	www.rainbird.com/webinars
YouTube	www.youtube.com/rainbirdcorp



Rain Bird Training Services

Features

- Rain Bird Training Services has the classes you need
- All instructors are credentialed and experienced irrigation professionals
- All classes are pre-approved for Irrigation Association (IA) CEUs.
- Flexible training options: regional classes, customized classes and private classes

Two Programs to Meet Your Needs

Rain Bird Academy

General Irrigation Skills Training

- Receive top quality training using products from many manufacturers
- Prepare for Irrigation Association (IA) certification exams
- Learn to design, install and maintain irrigation systems at our 4.5-day Boot Camp

Why the Rain Bird Academy Boot Camp?

- The Boot Camp focuses on helping you gain an additional revenue-generating advantage
- Participants will receive an extensive and comprehensive technical training experience centering on irrigation installation, troubleshooting, scheduling and design
- The Rain Bird Academy Boot Camp will assist irrigators in preparation for the IA's Certified Irrigation Technician (CIT) Exam

Rain Bird Factory Trained Program

Comprehensive training on Rain Bird products

- Become Factory Trained and differentiate yourself from the competition
- Learn to efficiently install, operate and maintain Rain Bird products and systems
- Be one of the first in your area to be Rain Bird Factory Trained



Why Rain Bird Factory Trained?

- The Rain Bird Factory Trained Program is exclusive to Rain Bird products, and the installation, operation and maintenance best practices for Rain Bird systems
- You will be eligible to receive a Rain Bird Factory Trained designation, which you can promote as recognition of receiving the highest level of in-depth training on Rain Bird products and systems



For pricing and course registration, please visit: www.rainbirdsolutions.com/training

How to Use This Catalog

Precipitation Rates

Rain Bird has calculated for you the precipitation rates for our comprehensive lines of impacts, sprays, and rotors. These rates are an indication of the approximate rate at which water is being applied. The equations used to calculate the precipitation rates are as follows:

Square Spacing		Triangular Spacing	
U.S.:	Metric:	U.S.:	Metric:
$PR = 96.3 \times \frac{gpm}{S \times S}$	$PR = 1000 \times \frac{m^3/h}{S \times S}$	$PR = 96.3 \times \frac{gpm}{S \times L}$	$PR = 1000 \times \frac{m^3/h}{S \times L}$

96.3 = Constant (inches/square foot/hour)

1000 = Constant (millimeter/square meter/hour)

gpm = Gallons per minute (applied to area by sprinklers)

m³/h = Cubic meters per hour (applied to area by sprinklers)

S = Spacing between sprinklers

L = Spacing between rows (S x 0.866)

Specification Information

The information in this catalog was accurate at the time of printing and may be used for proper specification of each product. For the most up-to-date information, go to the Rain Bird web site at www.rainbird.com.

ASABE Test Certification Statement

Rain Bird Corporation certifies that pressure, flow rate, and radius data for its products were determined and listed in accordance with ASABE Standard S398.1, Procedure for Sprinkler Testing and Performance Reporting, and are representative of performance of production sprinklers at the time of publication. Actual product performance may differ from the published specifications due to normal manufacturing variations and sample selection. All other specifications are solely the recommendations of Rain Bird Corporation.

Reference Charts

Information contained in this catalog is based upon generally accepted formulas, computations, and trade practices. Rain Bird Corporation, and its subsidiaries and affiliates, shall not be responsible or liable therefore if any problems, difficulties, or injuries should arise from or in connection with the use or application of this information, or if there is any error herein, typographical or otherwise.

Technical Support

Rain Bird Technical Support has the answers to your specific product and water-management questions. Call our toll-free Technical Service or Spec Hotline numbers, or for maximum convenience, access the Rain Bird web site. You'll get expert advice and the right solutions.

Technical Service	Spec Hotline	Internet Address
1-800-RAINBIRD (1-800-724-6247)	1-800-458-3005	www.rainbird.com

Pressure Loss Through Water Meters

Pressure Loss: psi
Nominal Size

Flow gpm	5/8"	3/4"	1"	1 1/2"	2"	3"	4"
1	0.2	0.1					
2	0.3	0.2					
3	0.4	0.3					
4	0.6	0.5	0.1				
5	0.9	0.6	0.2				
6	1.3	0.7	0.3				
7	1.8	0.8	0.4				
8	2.3	1.0	0.5				
9	3.0	1.3	0.6				
10	3.7	1.6	0.7				
11	4.4	1.9	0.8				
12	5.1	2.2	0.9				
13	6.1	2.6	1.0				
14	7.2	3.1	1.1				
15	8.3	3.6	1.2				
16	9.4	4.1	1.4	0.4			
17	10.7	4.6	1.6	0.5			
18	12.0	5.2	1.8	0.6			
19	13.4	5.8	2.0	0.7			
20	15.0	6.5	2.2	0.8			
22		7.9	2.8	1.0			
24		9.5	3.4	1.2			
26		11.2	4.0	1.4			
28		13.0	4.6	1.6			
30		15.0	5.3	1.8			
32			6.0	2.1	0.8		
34			6.9	2.4	0.9		
36			7.8	2.7	1.0		
38			8.7	3.0	1.2		
40			9.6	3.3	1.3		
42			10.6	3.6	1.4		
44			11.7	3.9	1.5		
46			12.8	4.2	1.6		
48			13.9	4.5	1.7		
50			15.0	4.9	1.9	0.7	
52				5.3	2.1		
54				5.7	2.2		
56				6.2	2.3		
58				6.7	2.5		
60				7.2	2.7		
65				8.3	3.2	1.1	
70				9.8	3.7	1.3	
75				11.2	4.3	1.5	
80				12.8	4.9	1.6	0.7
90				16.1	6.2	2.0	0.8
100				20.0	7.8	2.5	0.9
110					9.5	2.9	1.0
120					11.3	3.4	1.2
130					13.0	3.9	1.4
140					15.1	4.5	1.6
150					17.3	5.1	1.8
160					20.0	5.8	2.1
170						6.5	2.4
180						7.2	2.7
190						8.0	3.0
200						9.0	3.2
220						11.0	3.9
240						13.0	4.7
260						15.0	5.5
280						17.3	6.3
300						20.0	7.2
350							10.0
400							13.0
450							16.2
500							20.0

PVC Class 160 IPS Plastic Pipe

(1120, 1220) SDR 26 C=150

psi Loss per 100 Feet of Pipe (psi/100 ft.)

Sizes 1" through 6" Flow 1 through 600 gpm

Size	1"	1 1/4"	1 1/2"	2"	2 1/2"	3"	4"	6"		
O.D.	1.315	1.660	1.900	2.375	2.875	3.500	4.500	6.625		
I.D.	1.195	1.532	1.754	2.193	2.655	3.230	4.154	6.115		
Wall Thk	0.06	0.064	0.073	0.091	0.110	0.135	0.173	0.255		
Flow gpm	Velocity fps	psi Loss	Velocity fps	psi Loss	Velocity fps	psi Loss	Velocity fps	psi Loss	Velocity fps	psi Loss
1	0.29	0.02	0.17	0.01	0.13	0.00	0.08	0.00	0.06	0.00
2	0.57	0.06	0.35	0.02	0.27	0.01	0.17	0.00	0.12	0.00
3	0.86	0.14	0.52	0.04	0.40	0.02	0.25	0.01	0.17	0.00
4	1.14	0.23	0.70	0.07	0.53	0.04	0.34	0.01	0.23	0.00
5	1.43	0.35	0.87	0.11	0.66	0.05	0.42	0.02	0.29	0.01
6	1.72	0.49	1.04	0.15	0.80	0.08	0.51	0.03	0.35	0.01
7	2.00	0.66	1.22	0.20	0.93	0.10	0.59	0.03	0.41	0.01
8	2.29	0.84	1.39	0.25	1.06	0.13	0.68	0.04	0.46	0.02
9	2.57	1.05	1.57	0.31	1.20	0.16	0.76	0.05	0.52	0.02
10	2.86	1.27	1.74	0.38	1.33	0.20	0.85	0.07	0.58	0.03
11	3.15	1.52	1.91	0.45	1.46	0.23	0.93	0.08	0.64	0.03
12	3.43	1.78	2.09	0.53	1.59	0.28	1.02	0.09	0.70	0.04
14	4.00	2.37	2.44	0.71	1.86	0.37	1.19	0.12	0.81	0.05
16	4.58	3.04	2.78	0.91	2.12	0.47	1.36	0.16	0.93	0.06
18	5.15	3.78	3.13	1.13	2.39	0.58	1.53	0.20	1.04	0.08
20	5.72	4.59	3.48	1.37	2.66	0.71	1.70	0.24	1.16	0.09
22	6.29	5.48	3.83	1.64	2.92	0.85	1.87	0.29	1.27	0.11
24	6.87	6.44	4.18	1.92	3.19	1.00	2.04	0.34	1.39	0.13
26	7.44	7.47	4.53	2.23	3.45	1.15	2.21	0.39	1.51	0.15
28	8.01	8.57	4.87	2.56	3.72	1.32	2.38	0.45	1.62	0.18
30	8.58	9.73	5.22	2.91	3.98	1.50	2.55	0.51	1.74	0.20
35	10.01	12.95	6.09	3.87	4.65	2.00	2.97	0.68	2.03	0.27
40	11.44	16.58	6.96	4.95	5.31	2.56	3.40	0.86	2.32	0.34
45	12.87	20.62	7.83	6.16	5.98	3.19	3.82	1.08	2.61	0.42
50	14.30	25.07	8.70	7.48	6.64	3.87	4.25	1.31	2.90	0.52
55	15.73	29.91	9.57	8.93	7.30	4.62	4.67	1.56	3.19	0.62
60	17.16	35.14	10.44	10.49	7.97	5.43	5.10	1.83	3.48	0.72
65	18.59	40.75	11.31	12.17	8.63	6.30	5.52	2.12	3.77	0.84
70	20.02	46.75	12.18	13.96	9.29	7.23	5.95	2.44	4.06	0.96
75			13.05	15.86	9.96	8.21	6.37	2.77	4.35	1.09
80			13.92	17.87	10.62	9.25	6.80	3.12	4.64	1.23
85			14.79	20.00	11.29	10.35	7.22	3.49	4.93	1.38
90			15.66	22.23	11.95	11.51	7.64	3.88	5.22	1.53
95			16.53	24.57	12.61	12.72	8.07	4.29	5.51	1.69
100			17.41	27.02	13.28	13.99	8.49	4.72	5.80	1.86
110			19.15	32.24	14.61	16.69	9.34	5.63	6.37	2.22
120					15.93	19.61	10.19	6.61	6.95	2.61
130					17.26	22.74	11.04	7.67	7.53	3.03
140					18.59	26.08	11.89	8.80	8.11	3.47
150					19.92	29.64	12.74	10.00	8.69	3.94
160							13.59	11.27	9.27	4.44
170							14.44	12.60	9.85	4.97
180							15.29	14.01	10.43	5.53
190							16.14	15.49	11.01	6.11
200							16.99	17.03	11.59	6.72
225							19.11	21.18	13.04	8.36
250									14.49	10.16
275									15.94	12.12
300									17.39	14.24
325									18.83	16.51
350									13.70	7.30
375									14.68	8.29
400									15.66	9.34
425									16.64	10.45
450									17.62	11.62
475									18.60	12.85
500									19.58	14.13
550									13.02	4.96
600									14.20	5.82

Note: Dark shaded area of chart indicates velocities over 5' per second. Use with caution

The velocity values were derived using the following equation $V = \frac{0.4085 \times Q_{gpm}}{d^2}$

Table are based upon the following Hazen-Williams equation: $H_f = 0.2083 \times \left(\frac{100}{C}\right)^{1.852} \times \frac{Q^{1.852}}{D^{4.8655}}$ for change in psi per foot of elevation. Pressure loss for uphill elevation and pressure gain for downhill elevation changes.

PVC Class 200 IPS Plastic Pipe																
(1120, 1220) SDR 21 C=150																
psi Loss per 100 Feet of Pipe (psi/100 ft.)																
Sizes 3/4" through 6" Flow 1 through 600 gpm																
Size	3/4"	1"	1 1/4"	1 1/2"	2"	2 1/2"	3"	4"	6"							
O.D.	1.050	1.315	1.660	1.900	2.375	2.875	3.500	4.500	6.625							
I.D.	0.930	1.189	1.502	1.720	2.149	2.601	3.166	4.072	5.993							
Wall Thk	0.060	0.063	0.079	0.090	0.113	0.137	0.167	0.214	0.316							
Flow gpm	Velocity fps psi Loss		Velocity fps psi Loss		Velocity fps psi Loss		Velocity fps psi Loss		Velocity fps psi Loss		Velocity fps psi Loss		Velocity fps psi Loss			
1	0.47	0.06	0.29	0.02	0.18	0.01	0.14	0.00	0.09	0.00	0.06	0.00	0.04	0.00	0.02	0.00
2	0.94	0.22	0.58	0.07	0.36	0.02	0.28	0.01	0.18	0.00	0.12	0.00	0.08	0.00	0.05	0.00
3	1.42	0.46	0.87	0.14	0.54	0.04	0.41	0.02	0.27	0.01	0.18	0.00	0.12	0.00	0.07	0.00
4	1.89	0.79	1.16	0.24	0.72	0.08	0.55	0.04	0.35	0.01	0.24	0.01	0.16	0.00	0.10	0.00
5	2.36	1.19	1.44	0.36	0.91	0.12	0.69	0.06	0.44	0.02	0.30	0.01	0.20	0.00	0.12	0.00
6	2.83	1.67	1.73	0.51	1.09	0.16	0.83	0.08	0.53	0.03	0.36	0.01	0.24	0.00	0.15	0.00
7	3.31	2.23	2.02	0.67	1.27	0.22	0.97	0.11	0.62	0.04	0.42	0.01	0.29	0.01	0.17	0.00
8	3.78	2.85	2.31	0.86	1.45	0.28	1.10	0.14	0.71	0.05	0.48	0.02	0.33	0.01	0.20	0.00
9	4.25	3.55	2.60	1.07	1.63	0.34	1.24	0.18	0.80	0.06	0.54	0.02	0.37	0.01	0.22	0.00
10	4.72	4.31	2.89	1.30	1.81	0.42	1.38	0.22	0.88	0.07	0.60	0.03	0.41	0.01	0.25	0.00
11	5.20	5.14	3.18	1.56	1.99	0.50	1.52	0.26	0.97	0.09	0.66	0.03	0.45	0.01	0.27	0.00
12	5.67	6.04	3.47	1.83	2.17	0.59	1.66	0.30	1.06	0.10	0.72	0.04	0.49	0.02	0.30	0.00
14	6.61	8.04	4.05	2.43	2.54	0.78	1.93	0.40	1.24	0.14	0.85	0.05	0.57	0.02	0.34	0.01
16	7.56	10.29	4.62	3.11	2.90	1.00	2.21	0.52	1.42	0.17	0.97	0.07	0.65	0.03	0.39	0.01
18	8.50	12.80	5.20	3.87	3.26	1.24	2.49	0.64	1.59	0.22	1.09	0.09	0.73	0.03	0.44	0.01
20	9.45	15.56	5.78	4.71	3.62	1.51	2.76	0.78	1.77	0.26	1.21	0.10	0.82	0.04	0.49	0.01
22	10.39	18.56	6.36	5.62	3.98	1.80	3.04	0.93	1.95	0.32	1.33	0.12	0.90	0.05	0.54	0.01
24	11.34	21.80	6.93	6.60	4.35	2.12	3.31	1.09	2.12	0.37	1.45	0.15	0.98	0.06	0.59	0.02
26	12.28	25.29	7.51	7.65	4.71	2.45	3.59	1.27	2.30	0.43	1.57	0.17	1.06	0.07	0.64	0.02
28	13.22	29.01	8.09	8.78	5.07	2.82	3.87	1.46	2.48	0.49	1.69	0.19	1.14	0.07	0.69	0.02
30	14.17	32.96	8.67	9.97	5.43	3.20	4.14	1.65	2.65	0.56	1.81	0.22	1.22	0.09	0.74	0.02
35	16.53	43.85	10.11	13.27	6.34	4.26	4.83	2.20	3.10	0.75	2.11	0.29	1.43	0.11	0.86	0.03
40	18.89	56.16	11.56	16.99	7.24	5.45	5.52	2.82	3.54	0.95	2.42	0.38	1.63	0.14	0.99	0.04
45			13.00	21.14	8.15	6.78	6.21	3.51	3.98	1.19	2.72	0.47	1.83	0.18	1.11	0.05
50			14.45	25.69	9.05	8.24	6.90	4.26	4.42	1.44	3.02	0.57	2.04	0.22	1.23	0.06
55			15.89	30.65	9.96	9.83	7.59	5.08	4.86	1.72	3.32	0.68	2.24	0.26	1.35	0.08
60			17.34	36.01	10.86	11.55	8.28	5.97	5.31	2.02	3.62	0.80	2.45	0.31	1.48	0.09
65			18.78	41.76	11.77	13.40	8.98	6.93	5.75	2.34	3.92	0.93	2.65	0.36	1.60	0.10
70			20.23	47.90	12.68	15.37	9.67	7.95	6.19	2.69	4.23	1.06	2.85	0.41	1.72	0.12
75					13.58	17.46	10.36	9.03	6.63	3.06	4.53	1.21	3.06	0.46	1.85	0.14
80					14.49	19.68	11.05	10.18	7.08	3.44	4.83	1.36	3.26	0.52	1.97	0.15
85					15.39	22.02	11.74	11.39	7.52	3.85	5.13	1.52	3.46	0.58	2.09	0.17
90					16.30	24.48	12.43	12.66	7.96	4.28	5.43	1.69	3.67	0.65	2.22	0.19
95					17.20	27.05	13.12	13.99	8.40	4.73	5.74	1.87	3.87	0.72	2.34	0.21
100					18.11	29.75	13.81	15.38	8.85	5.21	6.04	2.06	4.08	0.79	2.46	0.23
110					19.92	35.49	15.19	18.35	9.73	6.21	6.64	2.45	4.48	0.94	2.71	0.28
120							16.57	21.56	10.61	7.30	7.25	2.88	4.89	1.11	2.96	0.33
130							17.95	25.01	11.50	8.46	7.85	3.34	5.30	1.28	3.20	0.38
140							19.33	28.69	12.38	9.71	8.45	3.84	5.71	1.47	3.45	0.43
150									13.27	11.03	9.06	4.36	6.11	1.67	3.70	0.49
160									14.15	12.43	9.66	4.91	6.52	1.89	3.94	0.55
170									15.04	13.91	10.27	5.50	6.93	2.11	4.19	0.62
180									15.92	15.46	10.87	6.11	7.34	2.35	4.43	0.69
190									16.81	17.09	11.47	6.75	7.74	2.59	4.68	0.76
200									17.69	18.80	12.08	7.43	8.15	2.85	4.93	0.84
225									19.90	23.38	13.59	9.23	9.17	3.55	5.54	1.04
250											15.10	11.22	10.19	4.31	6.16	1.27
275											16.61	13.39	11.21	5.15	6.77	1.51
300											18.11	15.73	12.23	6.05	7.39	1.78
325											19.62	18.25	13.25	7.01	8.01	2.06
350													14.26	8.04	8.62	2.36
375													15.28	9.14	9.24	2.69
400													16.30	10.30	9.85	3.03
425													17.32	11.52	10.47	3.39
450													18.34	12.81	11.09	3.77
475													19.36	14.16	11.70	4.16
500															12.32	4.58
550															13.55	5.46
600															14.78	6.41

Note: Dark shaded area of chart indicates velocities over 5' per second. Use with caution

The velocity values were derived using the following equation $V = \frac{0.4085 \times Q_{gpm}}{d^2}$

Table are based upon the following Hazen-Williams equation: $H_f = 0.2083 \times \left(\frac{100}{C}\right)^{1.852} \times \frac{Q^{1.852}}{D^{4.8655}}$ for change in psi per foot of elevation. Pressure loss for uphill elevation and pressure gain for downhill elevation changes.

PVC Schedule 80 IPS Plastic Pipe

(1120, 1220) C=150

psi Loss per 100 Feet of Pipe (psi/100 ft)

Sizes 1/2" through 6" Flow 1 through 600 gpm

Size	1/2"	3/4"	1"	1 1/4"	1 1/2"	2"	2 1/2"	3"	4"	6"		
O.D.	0.840	1.050	1.315	1.660	1.900	2.375	2.875	3.500	4.500	6.625		
I.D.	0.546	0.742	0.957	1.278	1.500	1.939	2.323	2.900	3.826	5.761		
Wall Thk	0.147	0.154	0.179	0.191	0.200	0.218	0.276	0.300	0.337	0.432		
Flow gpm	Velocity fps	psi Loss	Velocity fps	psi Loss	Velocity fps	psi Loss	Velocity fps	psi Loss	Velocity fps	psi Loss	Velocity fps	psi Loss
1	1.37	0.81	0.74	0.18	0.45	0.05	0.25	0.01	0.18	0.01	0.11	0.00
2	2.74	2.92	1.48	0.66	0.89	0.19	0.50	0.05	0.36	0.02	0.22	0.01
3	4.11	6.19	2.23	1.39	1.34	0.40	0.75	0.10	0.54	0.05	0.33	0.01
4	5.48	10.54	2.97	2.37	1.78	0.69	1.00	0.17	0.73	0.08	0.43	0.02
5	6.85	15.93	3.71	3.58	2.23	1.04	1.25	0.25	0.91	0.12	0.54	0.03
6	8.22	22.33	4.45	5.02	2.68	1.46	1.50	0.36	1.09	0.16	0.65	0.05
7	9.59	29.71	5.19	6.68	3.12	1.94	1.75	0.47	1.27	0.22	0.76	0.06
8	10.96	38.04	5.94	8.55	3.57	2.48	2.00	0.61	1.45	0.28	0.87	0.08
9	12.33	47.32	6.68	10.64	4.01	3.08	2.25	0.76	1.63	0.35	0.98	0.10
10	13.70	57.51	7.42	12.93	4.46	3.75	2.50	0.92	1.82	0.42	1.09	0.12
11	15.07	68.61	8.16	15.43	4.91	4.47	2.75	1.09	2.00	0.50	1.20	0.14
12	16.44	80.61	8.90	18.12	5.35	5.26	3.00	1.29	2.18	0.59	1.30	0.17
14			10.39	24.11	6.24	6.99	3.50	1.71	2.54	0.79	1.52	0.23
16			11.87	30.88	7.14	8.95	4.00	2.19	2.90	1.01	1.74	0.29
18			13.36	38.40	8.03	11.14	4.50	2.73	3.27	1.25	1.96	0.36
20			14.84	46.68	8.92	13.53	5.00	3.31	3.63	1.52	2.17	0.44
22			16.32	55.69	9.81	16.15	5.50	3.95	3.99	1.81	2.39	0.52
24			17.81	65.43	10.70	18.97	6.00	4.64	4.36	2.13	2.61	0.61
26			19.29	75.88	11.60	22.00	6.50	5.39	4.72	2.47	2.82	0.71
28					12.49	25.24	7.00	6.18	5.08	2.83	3.04	0.81
30					13.38	28.68	7.50	7.02	5.45	3.22	3.26	0.92
35					15.61	38.15	8.75	9.34	6.35	4.28	3.80	1.23
40					17.84	48.86	10.00	11.96	7.26	5.49	4.35	1.57
45							11.25	14.88	8.17	6.82	4.89	1.96
50							12.51	18.08	9.08	8.29	5.43	2.38
55							13.76	21.57	9.99	9.90	5.98	2.84
60							15.01	25.34	10.89	11.63	6.52	3.33
65							16.26	29.39	11.80	13.48	7.06	3.87
70							17.51	33.72	12.71	15.47	7.61	4.44
75							18.76	38.31	13.62	17.58	8.15	5.04
80							20.01	43.18	14.52	19.81	8.69	5.68
85									15.43	22.16	9.24	6.36
90									16.34	24.63	9.78	7.06
95									17.25	27.23	10.32	7.81
100									18.16	29.94	10.87	8.59
110									19.97	35.72	11.95	10.24
120											13.04	12.04
130											14.12	13.96
140											15.21	16.01
150											16.30	18.20
160											17.38	20.51
170											18.47	22.94
180											19.56	25.50
190											14.38	11.70
200											15.14	12.87
225											17.03	16.01
250											18.92	19.45
275											20.82	23.21
300											14.57	9.27
325											15.79	10.75
350											17.00	12.33
375											18.21	14.01
400											19.43	15.79
425											11.86	4.59
450											12.56	5.10
475											13.26	5.64
500											13.95	6.20
550											15.35	7.39
600											16.74	8.69

Note: Dark shaded area of chart indicates velocities over 5' per second. Use with caution

The velocity values were derived using the following equation $V = \frac{0.4085 \times Q_{gpm}}{d^2}$

Table are based upon the following Hazen-Williams equation: $H_f = 0.2083 \times \left(\frac{100}{C}\right)^{1.852} \times \frac{Q^{1.852}}{d^{4.8655}}$ for change in psi per foot of elevation. Pressure loss for uphill elevation and pressure gain for downhill elevation changes.

Schedule 40 Standard Steel Pipe

C=100

psi Loss per 100 Feet of Pipe (psi/100 ft.)

Sizes 1/2" through 6" Flow 1 through 600 gpm

Size	1/2"	3/4"	1"	1 1/4"	1 1/2"	2"	2 1/2"	3"	4"	6"		
O.D.	0.840	1.050	1.315	1.660	1.900	2.375	2.875	3.500	4.500	6.625		
I.D.	0.622	0.824	1.049	1.380	1.610	2.067	2.469	3.068	4.026	6.065		
Wall Thk	0.109	0.113	0.133	0.140	0.145	0.154	0.203	0.216	0.237	0.280		
Flow gpm	Velocity fps psi Loss		Velocity fps psi Loss		Velocity fps psi Loss		Velocity fps psi Loss		Velocity fps psi Loss		Velocity fps psi Loss	
1	1.06	0.91	0.60	0.23	0.37	0.07	0.21	0.02	0.16	0.01	0.10	0.00
2	2.11	3.28	1.20	0.84	0.74	0.26	0.43	0.07	0.32	0.03	0.19	0.01
3	3.17	6.95	1.80	1.77	1.11	0.55	0.64	0.14	0.47	0.07	0.29	0.02
4	4.22	11.84	2.41	3.01	1.48	0.93	0.86	0.25	0.63	0.12	0.38	0.03
5	5.28	17.91	3.01	4.56	1.86	1.41	1.07	0.37	0.79	0.18	0.48	0.05
6	6.34	25.10	3.61	6.39	2.23	1.97	1.29	0.52	0.95	0.25	0.57	0.07
7	7.39	33.39	4.21	8.50	2.60	2.63	1.50	0.69	1.10	0.33	0.67	0.10
8	8.45	42.76	4.81	10.88	2.97	3.36	1.72	0.89	1.26	0.42	0.76	0.12
9	9.50	53.18	5.41	13.54	3.34	4.18	1.93	1.10	1.42	0.52	0.86	0.15
10	10.56	64.64	6.02	16.45	3.71	5.08	2.15	1.34	1.58	0.63	0.96	0.19
11	11.61	77.12	6.62	19.63	4.08	6.06	2.36	1.60	1.73	0.75	1.05	0.22
12	12.67	90.60	7.22	23.06	4.45	7.12	2.57	1.88	1.89	0.89	1.15	0.26
14	14.78	120.54	8.42	30.68	5.20	9.48	3.00	2.50	2.21	1.18	1.34	0.35
16	16.89	154.35	9.63	39.29	5.94	12.14	3.43	3.20	2.52	1.51	1.53	0.45
18	19.01	191.98	10.83	48.87	6.68	15.10	3.86	3.98	2.84	1.88	1.72	0.56
20			12.03	59.39	7.42	18.35	4.29	4.83	3.15	2.28	1.91	0.68
22			13.24	70.86	8.17	21.89	4.72	5.76	3.47	2.72	2.10	0.81
24			14.44	83.25	8.91	25.72	5.15	6.77	3.78	3.20	2.29	0.95
26			15.64	96.55	9.65	29.83	5.58	7.85	4.10	3.71	2.49	1.10
28			16.85	110.76	10.39	34.22	6.01	9.01	4.41	4.26	2.68	1.26
30			18.05	125.85	11.14	38.88	6.44	10.24	4.73	4.84	2.87	1.43
35					12.99	51.73	7.51	13.62	5.52	6.43	3.35	1.91
40					14.85	66.24	8.58	17.44	6.30	8.24	3.82	2.44
45					16.71	82.38	9.65	21.69	7.09	10.25	4.30	3.04
50					18.56	100.14	10.73	26.37	7.88	12.46	4.78	3.69
55							11.80	31.46	8.67	14.86	5.26	4.41
60							12.87	36.96	9.46	17.46	5.74	5.18
65							13.94	42.87	10.24	20.25	6.21	6.00
70							15.02	49.17	11.03	23.23	6.69	6.89
75							16.09	55.87	11.82	26.39	7.17	7.83
80							17.16	62.97	12.61	29.74	7.65	8.82
85							18.23	70.45	13.40	33.28	8.13	9.87
90							19.31	78.32	14.18	36.99	8.61	10.97
95									14.97	40.89	9.08	12.12
100									15.76	44.96	9.56	13.33
110									17.34	53.64	10.52	15.91
120									18.91	63.02	11.47	18.69
130									12.43	21.67	8.71	9.13
140									13.39	24.86	9.38	10.47
150									14.34	28.25	10.05	11.90
160									15.30	31.84	10.72	13.41
170									16.25	35.62	11.39	15.00
180									17.21	39.60	12.06	16.68
190									18.17	43.77	12.73	18.43
200									19.12	48.13	13.40	20.27
225									15.08	25.21	9.76	8.76
250									16.75	30.64	10.85	10.65
275									18.43	36.56	11.93	12.71
300									13.02	14.93	7.56	3.98
325									14.10	17.31	8.19	4.62
350									15.19	19.86	8.82	5.29
375									16.27	22.57	9.45	6.02
400									17.36	25.43	10.08	6.78
425									18.44	28.46	10.71	7.58
450									19.53	31.63	11.34	8.43
475											11.97	9.32
500											12.60	10.25
550											13.86	12.23
600											15.12	14.36

Note: Dark shaded area of chart indicates velocities over 5' per second. Use with caution

The velocity values were derived using the following equation $V = \frac{0.4085 \times Q_{gpm}}{d^2}$

Table are based upon the following Hazen-Williams equation: $H_f = 0.2083 \times \left(\frac{100}{C}\right)^{1.852} \times \frac{Q^{1.852}}{D^{4.8655}}$ for change in psi per foot of elevation. Pressure loss for uphill elevation and pressure gain for downhill elevation changes.

Type K Copper Water Tube																		
C=140																		
psi Loss per 100 Feet of Tube (psi/100 ft.)																		
Sizes 1/2" through 3" Flow 1 through 600 gpm																		
Size	1/2"		5/8"		3/4"		1"		1 1/4"		1 1/2"		2"		2 1/2"		3"	
O.D.	0.625		0.750		0.875		1.125		1.375		1.625		2.125		2.625		3.125	
I.D.	0.5270		0.652		0.745		0.995		1.245		1.481		1.959		2.435		2.907	
Wall Thk	0.049		0.049		0.065		0.065		0.065		0.072		0.083		0.095		0.109	
Flow gpm	Velocity fps psi Loss		Velocity fps psi Loss		Velocity fps psi Loss		Velocity fps psi Loss		Velocity fps psi Loss		Velocity fps psi Loss		Velocity fps psi Loss		Velocity fps psi Loss		Velocity fps psi Loss	
1	1.47	1.09	0.96	0.39	0.74	0.20	0.41	0.05	0.26	0.02	0.19	0.01	0.11	0.00	0.07	0.00	0.05	0.00
2	2.94	3.94	1.92	1.40	1.47	0.73	0.83	0.18	0.53	0.06	0.37	0.03	0.21	0.01	0.14	0.00	0.10	0.00
3	4.41	8.35	2.88	2.96	2.21	1.55	1.24	0.38	0.79	0.13	0.56	0.05	0.32	0.01	0.21	0.00	0.15	0.00
4	5.88	14.23	3.84	5.05	2.94	2.64	1.65	0.65	1.05	0.22	0.74	0.09	0.43	0.02	0.28	0.01	0.19	0.00
5	7.35	21.51	4.80	7.64	3.68	3.99	2.06	0.98	1.32	0.33	0.93	0.14	0.53	0.04	0.34	0.01	0.24	0.01
6	8.83	30.14	5.77	10.70	4.42	5.59	2.48	1.37	1.58	0.46	1.12	0.20	0.64	0.05	0.41	0.02	0.29	0.01
7	10.30	40.11	6.73	14.24	5.15	7.44	2.89	1.82	1.84	0.61	1.30	0.26	0.75	0.07	0.48	0.02	0.34	0.01
8	11.77	51.36	7.69	18.23	5.89	9.53	3.30	2.33	2.11	0.78	1.49	0.34	0.85	0.09	0.55	0.03	0.39	0.01
9	13.24	63.88	8.65	22.68	6.62	11.85	3.71	2.90	2.37	0.97	1.68	0.42	0.96	0.11	0.62	0.04	0.44	0.02
10	14.71	77.64	9.61	27.56	7.36	14.41	4.13	3.52	2.64	1.18	1.86	0.51	1.06	0.13	0.69	0.05	0.48	0.02
11	16.18	92.63	10.57	32.88	8.10	17.19	4.54	4.21	2.90	1.41	2.05	0.61	1.17	0.16	0.76	0.05	0.53	0.02
12	17.65	108.82	11.53	38.63	8.83	20.19	4.95	4.94	3.16	1.66	2.23	0.71	1.28	0.18	0.83	0.06	0.58	0.03
14			13.45	51.40	10.30	26.87	5.78	6.57	3.69	2.21	2.61	0.95	1.49	0.24	0.96	0.08	0.68	0.04
16			15.38	65.82	11.78	34.40	6.60	8.42	4.22	2.83	2.98	1.22	1.70	0.31	1.10	0.11	0.77	0.05
18			17.30	81.86	13.25	42.79	7.43	10.47	4.74	3.52	3.35	1.51	1.92	0.39	1.24	0.13	0.87	0.06
20			19.22	99.50	14.72	52.01	8.25	12.72	5.27	4.28	3.72	1.84	2.13	0.47	1.38	0.16	0.97	0.07
22					16.19	62.05	9.08	15.18	5.80	5.10	4.10	2.19	2.34	0.56	1.52	0.20	1.06	0.08
24					17.66	72.90	9.90	17.84	6.33	5.99	4.47	2.58	2.55	0.66	1.65	0.23	1.16	0.10
26					19.14	84.55	10.73	20.69	6.85	6.95	4.84	2.99	2.77	0.77	1.79	0.27	1.26	0.11
28							11.55	23.73	7.38	7.97	5.21	3.43	2.98	0.88	1.93	0.30	1.35	0.13
30							12.38	26.96	7.91	9.06	5.59	3.89	3.19	1.00	2.07	0.35	1.45	0.15
35							14.44	35.87	9.22	12.05	6.52	5.18	3.73	1.33	2.41	0.46	1.69	0.19
40							16.50	45.94	10.54	15.44	7.45	6.63	4.26	1.70	2.76	0.59	1.93	0.25
45							18.57	57.13	11.86	19.20	8.38	8.25	4.79	2.12	3.10	0.73	2.18	0.31
50									13.18	23.33	9.31	10.03	5.32	2.57	3.44	0.89	2.42	0.38
55									14.49	27.84	10.24	11.96	5.85	3.07	3.79	1.06	2.66	0.45
60									15.81	32.71	11.17	14.06	6.39	3.60	4.13	1.25	2.90	0.53
65									17.13	37.93	12.11	16.30	6.92	4.18	4.48	1.45	3.14	0.61
70									18.45	43.51	13.04	18.70	7.45	4.79	4.82	1.66	3.38	0.70
75									19.77	49.44	13.97	21.25	7.98	5.45	5.17	1.89	3.63	0.80
80											14.90	23.95	8.52	6.14	5.51	2.13	3.87	0.90
85											15.83	26.79	9.05	6.87	5.86	2.38	4.11	1.01
90											16.76	29.78	9.58	7.64	6.20	2.65	4.35	1.12
95											17.69	32.92	10.11	8.44	6.55	2.93	4.59	1.24
100											18.62	36.20	10.64	9.28	6.89	3.22	4.83	1.36
110													11.71	11.07	7.58	3.84	5.32	1.62
120													12.77	13.01	8.27	4.52	5.80	1.91
130													13.84	15.09	8.96	5.24	6.28	2.21
140													14.90	17.31	9.65	6.01	6.77	2.54
150													15.97	19.67	10.33	6.83	7.25	2.88
160													17.03	22.17	11.02	7.69	7.73	3.25
170													18.10	24.80	11.71	8.61	8.22	3.63
180													19.16	27.57	12.40	9.57	8.70	4.04
190															13.09	10.58	9.18	4.47
200															13.78	11.63	9.67	4.91
225															15.50	14.46	10.88	6.11
250															17.22	17.58	12.08	7.42
275															18.95	20.97	13.29	8.86
300																	14.50	10.41
325																	15.71	12.07
350																	16.92	13.84
375																	18.13	15.73
400																	19.34	17.73
425																		
450																		
475																		
500																		
550																		

Note: Dark shaded area of chart indicates velocities over 5' per second. Use with caution

The velocity values were derived using the following equation $V = \frac{0.4085 \times Q_{gpm}}{d^2}$

Table are based upon the following Hazen-Williams equation: $H_f = 0.2083 \times \left(\frac{100}{C}\right)^{1.852} \times \frac{Q^{1.852}}{D^{4.8655}}$ for change in psi per foot of elevation. Pressure loss for uphill elevation and pressure gain for downhill elevation changes.

Customer Service

At Rain Bird, we believe that when you purchase our products, you should also receive the support you need to ensure that they perform as designed. Like our products, Rain Bird customer service is designed to exceed expectations. When you call with questions about orders or new products, you get the support you need from the top water management professionals in the industry backed by our vast global network of distributor-partners.

Worry-Free Warranties

Our comprehensive product warranties make it even easier to choose Rain Bird and relax. Most Rain Bird Landscape Irrigation products are warranted to the trade for a period of either three or five years from the date of original purchase. A Rain Bird warranty is hassle-free support that enables maximum peak performance by irrigation system professionals. For you, it's the added peace of mind of knowing Rain Bird is there when you need it.

Rain Bird's Professional Customer Satisfaction Policy

Rain Bird will repair or replace at no charge any Rain Bird professional product that fails in normal use within the warranty period stated below. You must return it to the dealer or distributor where you bought it. Product failures due to acts of God including without limitation, lightning and flooding, are not covered by this warranty. This commitment to repair or replace is our sole and total warranty.

Implied Warranties of Merchantability and Fitness, if Applicable, are Limited to One Year from the Date of Sale.

We will not, under any circumstances be liable for incidental or consequential damages, no matter how they occur.

I. Landscape Irrigation and Drainage Products

1800 Series Pop-Up Spray Heads, U-Series Nozzles, PA-8S and PA-8S-PRS Shrub Adapters, 1300 and 1400 Bubblers, 5000 Series Rotors, 5500 Series Rotors, 8005 Series Rotors, Falcon® 6504 Series Rotors, PEB/PESB/PESB-R Plastic Valves, DV/DVF and ASVF Plastic Valves, VB Series Valve Boxes and XF Series Dripline* – 5 years

C2 Power Unit – 2 years

Pump Start Relays – 1 year for controls/electronics, 2 years for enclosure

All other Landscape Irrigation and Drainage products – 3 years

II. Golf Products, Agricultural Products, and Pump Stations

For complete information and details please visit:

<http://www.rainbird.com/corporate/CustomerSatisfactionPolicy.htm>

V. All Other Products - 1 year

*XF Series Dripline - 7 Years on Environmental Stress Cracking (ESCR)

For more information, see your Rain Bird Distributor. To find the nearest authorized distributor in your area, visit www.rainbird.com or call 1-800-RAINBIRD

Index

½" FPT x Barb Grey Transfer Fitting	112	IQ™ v2.0 Central Control Software.....	98	RWS (Root Watering System).....	124
¼" Barb Transfer Fittings.....	137	Landscape Irrigation and Maintenance		SA Series	14
¼" Landscape Dripline	136	Remote 3.0 (LIMR)	89	SB Series Spiral Barb Fittings	15
¼" Self-Piercing Barb Connector.....	112	Large-Capacity Filters	151	SH Series.....	74
¼" Tubing Stake with Cap	122	Locking Cover Key	74	SiteControl.....	100
6 Outlet Manifold - EMT-6Xeri	112	Low Flow Control Zone Kits with Anti-Siphon		SiteControl Hardware	101
10-32 Thread Adapter	123	Valve and PR Filter.....	142	SMRT-Y Soil Moisture Sensor Kit.....	94
12" PolyFlex Riser.....	123	Low Flow Control Zone Kits with PR Filter.....	141	SPLICE-1	74
300-BPE/300-BPES Brass Valves.....	70	Low Flow Valves.....	147	Spray-to-Drip Retrofit Kit.....	138
1300A-F	35	Maxicom ²⁰	102	Spread Spectrum Radio.....	105
1400 Series.....	35	Maxicom ²⁰ Hardware	103	SPX Series Swing Pipe.....	15
1800 [®] -EXT	11	Medium Flow Commercial Control Zone Kit		Square Basin Kits.....	173
1800 [®] NP Cover	11	with Pressure Regulating, Basket Filter.....	145	Square Catch Basins.....	172
1800 PCS.....	11	Medium Flow Control Zone Kits with		Square Low-Profile Basins.....	173
1800 [®] -SAM, -PRS, SAM-PRS, SAM-P45 Series.....	9	Anti-Siphon Valve and PR Filter	142	Subterranean Emitter Box.....	137
1800 [®] Series.....	8	Medium Flow Control Zone Kits with PR Filter.		TBOS-II™.....	90
1800 Xeri-Bubbler Adapter.....	123	Flow Control.....	143	Technical Support.....	177
2045A Maxi-Paw™ and 2045-PJ Maxi-Bird™.....	55	Medium Flow Light Commercial Control Zone		TSJ/TSJ-PRS Series.....	57
3500 Series.....	37	Kit with Pressure Regulating, Basket Filter	144	Tubing Cutter	137
5000 Series.....	39	Multi-Outlet Xeri-Bug™.....	112	Tubing Goof Plug	137
5000 Series MPR Nozzles.....	45	Online Control Zone Kit Selection Guide.....	139	UNI-Spray™ Series.....	7
8005 Series.....	51	PA.....	11	Universal ¼" Tubing Stake.....	122
Air/Vacuum Relief Valve Kit.....	134	PA-8S-PRS.....	11	Universal Square Grates.....	171
Anemometer Wind Sensor	105	PA-80	11	Valve Keys.....	74
ASVF Series.....	61	PBC-LXD Programming Backup Cartridge		VAN Series Nozzles.....	24
Basin Adapters and Accessories	174	for ESP-LXD.....	95	VB Series Valve Boxes	76
Central Control Global Service Plans	106	PC Diffuser Cap	122	Worry-Free Warranties	186
Commercial Valve Wire Sizing Procedure.....	77	PC Diffuser Caps	115	WR2 Series Wireless Rain/Freeze Sensors.....	93
Controller Pedestals.....	95	PEB / PESB Series.....	65	WS-PRO Weather Stations.....	104
Control Zone Kits	140	PESB-R Series Valves.....	67	XBS - Black Stripe Tubing.....	135
Control Zone Kit Selection Guide.....	139	PGA Series	63	Xeri-Bird™ 8 Multi-Outlet Emission Device.....	113
Customer Service	186	Pigtail	95	Xeri-Bubblers™.....	119
DB Series Wire Connectors.....	71	Plastic MPR Nozzles	17	Xeri-Bug™ Emitters.....	110
Diffuser Bug Cap	122	Plastic Round Grates	169	Xeri-Caps™ for Spray Heads	138
DPU-210 Decoder Programming Unit.....	88	Plastic Square Grates.....	170	Xerigation®/ Landscape Drip System	
Drainage Pop-Up Valves	174	Plastic U-Series Nozzles	21	Overview.....	108
Drip System Operation Indicator.....	134	PolyFlex Riser and Adapter Assemblies.....	123	Xeriman™ Tool.....	138
DV / DVF Series	59	PolyFlex Riser and Stake Assembly.....	123	Xeri-Pop™ Micro-Spray.....	118
Easy Fit Compression Fitting System	132	Pressure-Compensating Modules.....	114	Xeri-Sprays™ and Misters.....	120
EFB-CP Series Brass Valves.....	69	Pressure Loss Reference Charts.....	177	Xeri-Spray™ 360° True Spray	120
ESP-LX Basic Controllers.....	84	Pressure Regulating, and Quick-Check Pressure		XFCV Dripline with Heavy-Duty Check Valve	127
ESP-LXD Decoder Controller	86	Regulating Basket Filters.....	150	XFD On-Surface Dripline	125
ESP-LXME Controllers	85	Pressure-Regulating Filter (RBY).....	148	XF Dripline Insert Fittings	131
ESP-Me Series Controllers.....	82	PRS-Dial.....	72	XF Series Blank Tubing	133
ESP-RZX Series Controller	81	PSR and PSRP Pump Start Relays.....	159	XF Series Dripline Insert Adapter for 1", 1½"	
ESP-SMTe Smart Modular Control System.....	83	Purple Valve Handle Assembly	74	or larger PVC	134
ET Manager™ Cartridge	88	PVB Professional Series Valve Boxes.....	75	XFS Sub-Surface Dripline with Copper Shield™	
Falcon® 6504 Series	47	Quick-Check Basket Filter	149	Technology	129
FD-TURF Two-Wire Decoders.....	87	Quick-Coupling Valves	73	XQ ¼" Distribution Tubing	136
Flow Sensors and Transmitters.....	91	Rain Bird Online Resources and Contacts List ..	175	XT-700 Distribution Tubing.....	133
Galvanized Tie-Down Stake	137	Rain Bird Training Services	176		
HE-VAN Series Nozzles	28	Rain Curtain™ Nozzle Cross Reference Guide	54		
High Flow Commercial Control Zone Kit with		RD1800™ Series Spray Heads.....	10		
2 Pressure Regulating, Basket Filters	146	Retrofit Pressure Regulators.....	152		
Holdup Tool with Bubble Level.....	42	Riser Stake-Threaded.....	123		
How to Use This Catalog	177	Rotary Nozzles	31		
HV Series.....	62	ROTORTOOL	42		
Inline Pressure Regulators.....	152	Round Catch Basins	171		
Inline RBY Filter	148	RSD-BEx / RSD-CEx.....	92		
IQ NCC Network Communication Cartridge.....	99	R-VAN Series Nozzles.....	33		

The Intelligent Use of Water.™

LEADERSHIP • EDUCATION • PARTNERSHIPS • PRODUCTS

At Rain Bird, we believe it is our responsibility to develop products and technologies that use water efficiently. Our commitment also extends to education, training and services for our industry and our communities.

The need to conserve water has never been greater. We want to do even more, and with your help, we can. Visit www.rainbird.com for more information about The Intelligent Use of Water.™



Rain Bird Corporation
6991 E. Southpoint Road
Tucson, AZ 85756
Phone: (520) 741-6100
Fax: (520) 741-6522

Rain Bird Technical Services
(800) RAINBIRD (1-800-724-6247)
(U.S. and Canada)

Rain Bird Corporation
970 West Sierra Madre Avenue
Azusa, CA 91702
Phone: (626) 812-3400
Fax: (626) 812-3411

Specification Hotline
800-458-3005 (U.S. and Canada)

Rain Bird International, Inc.
1000 West Sierra Madre
Azusa, CA 91702
Phone: (626) 963-9311
Fax: (626) 852-7343

www.rainbird.com